

CATALOGUS BALS NEDERLAND



Inhoud

Informatie

Over Ons	4
INNOLINQ	6
QUICK-CONNECT	10
KONTEX-ULTRA	12
MULTI-GRIP	14
VARIABOX	16
Combinatiemogelijkheden boven de 50V	18
Technische informatie	19
IP-beschermingsgraden	20
Uw voordelen- Onze ervaring	21
Materiaalbestendigheidlijst	22
Informatie over gebruikte materialen	23

Contactdozen

CEE-wandcontactdozen IP44	25
CEE-wandcontactdozen IP67	27
CEE-wandcontactdozen TK-combinatie	30
CEE-wandcontactdozen TE IP44	32
CEE-wandcontactdozen TE IP67	34
CEE-wandcontactdozen met pilotcontact	36
CEE-wandcontactdozen beveiligd IP44	38
CEE-wandcontactdozen beveiligd IP67	40
CEE-wandcontactdozen afschakelbaar vergrendelbaar IP44	42
CEE-wandcontactdozen afschakelbaar vergrendelbaar IP67	43
CEE-wandcontactdozen afschakelbaar vergrendelbaar beveiligd IP44	45
CEE-wandcontactdozen afschakelbaar vergrendelbaar beveiligd IP67	47
CEE-wandcontactdozen afschakelbaar vergrendelbaar zware omstandigheden IP67	48
CEE-inbouwcontactdozen recht IP44	49
CEE-inbouwcontactdozen schuin IP44	51
CEE-inbouwcontactdozen recht IP67	54
CEE-inbouwcontactdozen schuin IP67	56
CEE-inbouwcontactdozen met hulpcontact of pilotcontact	59
CEE-inbouwcontactdozen TE IP44	60
CEE-inbouwcontactdozen TE IP67	62

Stekers, Koppelingen en toestelcontactdozen

CEE-stekers IP44/IP54	67
CEE-stekers IP67	69
CEE-toestelcontactdozen opbouw IP44	71
CEE-toestelcontactdozen opbouw IP67	74
CEE-toestelcontactdozen aanbouw IP44	76
CEE-toestelcontactdozen aanbouw IP67	78
CEE-toestelcontactdozen inbouw IP44	80
CEE-toestelcontactdozen inbouw IP67	81
CEE-fasenwisselaars IP44	82
CEE-fasenwisselaars IP67	85
CEE-koppelingen IP44/IP54	86
CEE-koppelingen IP67	88

Schuko-contactmaterialen

Schuko-contactdozen	95
Schuko-stekers	97
Schuko-koppelingen	98

Verdelers

VARIABOX IP44	103
FRONTBOX IP44	121
Klapvensters IP44	122
Accessoires en toebehoren VARIABOX	125

Speciale contactmaterialen

7-polig CEE-contactmaterialen IP44	129
7-polig CEE-contactmaterialen IP67	132
Laagspanning contactmaterialen	136
CEE-gelijkstroom contactmaterialen	139

Speciale toepassingen

CEE-contactmaterialen, Type NATO	145
CEE-contactmaterialen, Type NATO	145

© 2024 Bals Nederland B.V., alle rechten voorbehouden. Aan de inhoud van deze catalogus kunnen geen rechten ontleend worden. Hoewel de inhoud van deze catalogus zorgvuldig tot stand is gekomen kunnen er fouten en afwijkingen in de maten, gewichten, de technische data, de afbeeldingen en dergelijke van de producten voorkomen.

Als je contact maakt, doe het dan goed



Bij Bals draait alles om duurzame verbinding

Met elkaar,
met onze relaties
en met de natuur.

Met Bals kies je niet alleen voor duurzaamheid maar ook voor de beste prestaties. Van CEE-contactdozen, -stekers, -koppelingen en verdelers tot autolaadkabels en led-producten.

Bals producten zijn voor installateurs en industrie verkrijgbaar bij de elektrotechnische groothandel.

Eenvoudig in gebruik en met de hoogste maatstaven voor duurzaamheid en kwaliteit ben je met Bals:

Simply. Well. Connected.

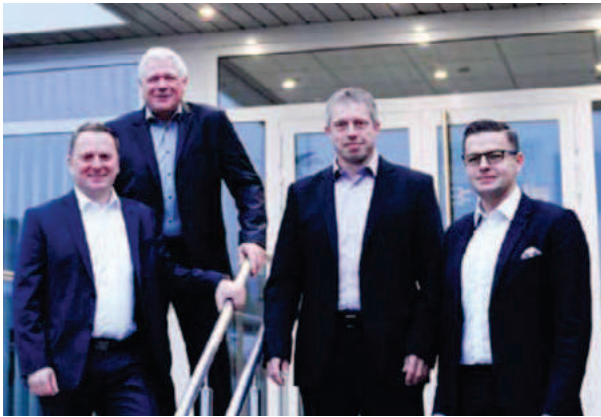

Duurzaam verbonden

Bals Nederland B.V. is een dochtermaatschappij van het Duitse familiebedrijf Bals Elektrotechnik GmbH & Co. KG. Al meer dan 60 jaar produceert Bals voor de wereldmarkt CEE-contactmaterialen die zich kenmerken door de hoogste kwaliteit van producten Made in Germany. Bij familiebedrijf Bals draait alles om duurzame verbinding. Met elkaar, met onze relaties en met de natuur. Dat zit in de genen van team Bals. Je wilt de wereld beter nalaten aan toekomstige generaties. Op de foto links de directie van Bals Duitsland: Hubertus Fischer, Wolfgang Bals, Johannes Rahm en Piotr Komor (vlnr).

Duurzame bedrijfsvoering

Bals maakt zich sterk voor de 17 duurzame ontwikkelingsdoelen die op de VN-agenda 2030 staan. Met overtuiging vertaalt Bals deze VN agenda naar een duurzame bedrijfsvoering door onder andere:

- Het terugdringen van energieverbruik en CO2 uitstoot met onder meer een energieneutraal bedrijfspand in Haarlem en een zonnepanelenpark van 10.000 m² voor de fabriek van Bals in Freiwalden, Duitsland.
- Het voortdurend innoveren van de producten en productie processen, resulterend in een grondstofbesparende productie van producten die vrij zijn van schadelijke stoffen (zoals Cadmium en Lood) en die volledig recyclebaar zijn.
- Het nemen van verantwoordelijkheid voor recycling van producten waarvoor Bals volgens Europese regelgeving (WEEE) producentenverantwoordelijkheid heeft.
- Voortdurende aandacht voor de kwaliteit van de processen en producten die minimaal aan de strengste eisen van klanten en wetgevers moeten voldoen. De producten en processen zijn VDE, ISO 9001 en ISO 14001 gecertificeerd.
- Productie in Duitsland en assemblage in Nederland met een grote verantwoordelijkheid voor het welzijn van de medewerkers en een boven gemiddeld aantal mensen met een afstand tot de arbeidsmarkt.
- De bedrijven van Bals hebben een sterke lokale binding en zijn vaak gevestigd in kleine steden. We willen met onze bedrijfsactiviteiten bijdragen aan het versterken van de lokale gemeenschap op de lange termijn.

SUSTAINABLE DEVELOPMENT GOALS



Ik voelde direct
een klik met Bals

Wim | Installateur

**Als je contact maakt,
doe het dan goed**



**Kies voor duurzame verbindingen
met INNOLINQ, recyclebaar
en loodvrij**



Scan de QR code
of ga naar www.bals.nl
voor meer informatie

 **Bals**

Simply. Well. Connected.
www.bals.nl

INNOLINQ

Als je contact maakt, doe het dan goed met onze baanbrekende industriële INNOLINQ contactmaterialen. INNOLINQ combineert de hoogste normen van innovatieve technologie met een maximale inzet voor duurzaamheid. Kortom: duurzame kwaliteit, "Made in Germany". De kwaliteit blijkt uit elk detail: het nieuwe ontwerp, de verbeterde ergonomie, maximale stabiliteit, grotere contactoppervlakken en verminderde insteek- en uittrekkkrachten. Met INNOLINQ kies je bovendien voor duurzaamheid. INNOLINQ producten zijn loodvrij en grondstofbesparend gemaakt van uitsluitend recyclebare materialen.



Reach en Rohs compliant

De loodvrije INNOLINQ producten voldoen aan de strenge REACH- en RoHS-richtlijnen van de EU. Lood verdween al uit allerlei producten zoals benzine en verf en staat op de REACH kandidatenlijst als stof die op termijn geheel verboden zal worden in de EU.



VDE-gecertificeerd

Het VDE-keurmerk op de INNOLINQ producten is de garantie voor geteste, veilige en normconforme producten. Daarnaast controleren en documenteren we de hoge productstandaard in ons eigen testlaboratorium door middel van geselecteerde thermische, mechanische en elektrische tests.



Onderhoudsvrije verbinding

INNOLINQ garandeert een veilige en absoluut zekere aansluiting van de aders. De aansluiting is ongevoelig voor trillingen en temperatuurschommelingen dankzij de unieke veerverbindingstechnologie van Bals. Met één vingertip wordt de ingestoken, gestripte ader zichtbaar en hoorbaar afgesloten. Een absoluut betrouwbare en permanente verbinding is het resultaat. Onderhoudscontroles voor loslatende schroefjes is hiermee verleden tijd.



Verbeterde ergonomie

Het gebruiksgemak en een perfecte grip, ook in ruige omstandigheden, zijn het gevolg van de geoptimaliseerde contouren van de behuizing. De herziene ergonomie maakt het ook gemakkelijker om het scharnierende deksel te openen.



Uiterst robuust

Industriële stekers en contactdozen moeten bestand zijn tegen extreem mechanische, thermische en chemische belasting. Daarom maken we INNOLINQ van geselecteerde, recyclebare en tegelijkertijd extreem robuuste en resistente materialen voor maximale duurzaamheid en betrouwbaarheid.



Schroefloze installatie

Installeren zonder gereedschap, dankzij QUICK-CONNECT. Zo eenvoudig is het: draai met de hand de behuizing los, steek de aansluitkabel door de open MULTI-GRIP wartel, steek de gestripte aders in de open klemmen en sluit met een klik. Draai tenslotte de behuizing en de MULTI-GRIP wartel met de hand vast.



Gebruiksgemak en een perfecte grip in elke situatie.



De nieuwe INNOLINQ CEE-stekers en -contactdozen zijn verkrijgbaar van 16A tot 32A.



Als je contact maakt, doe het dan goed

De nieuwe INNOLINQ serie CEE-contactmaterialen, recyclebaar en loodvrij, combineert drie innovaties die het resultaat zijn van intensief onderzoek en ontwikkeling. Ten eerste betreft het de compleet nieuwe KONTEX-ULTRA verbindingstechnologie met loodvrije contacten die niet alleen lichter zijn dan voorheen, maar ook uiterst duurzaam.

Bovendien is het grondstoffenverbruik aanzienlijk verminderd met behoud van dezelfde stabiliteit en geleidbaarheid als traditionele contacten. De andere twee innovaties van INNOLINQ producten betreffen optimalisaties van de gepatenteerde QUICK-CONNECT verbindingstechnologie en de MULTI-GRIP-wartel.

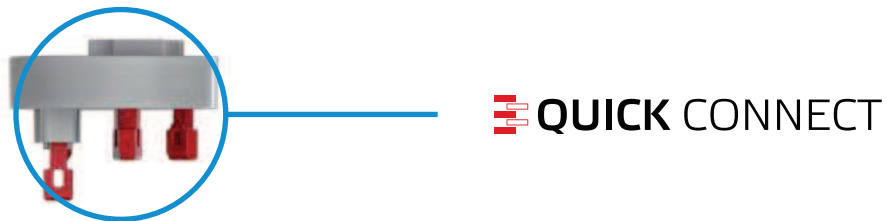
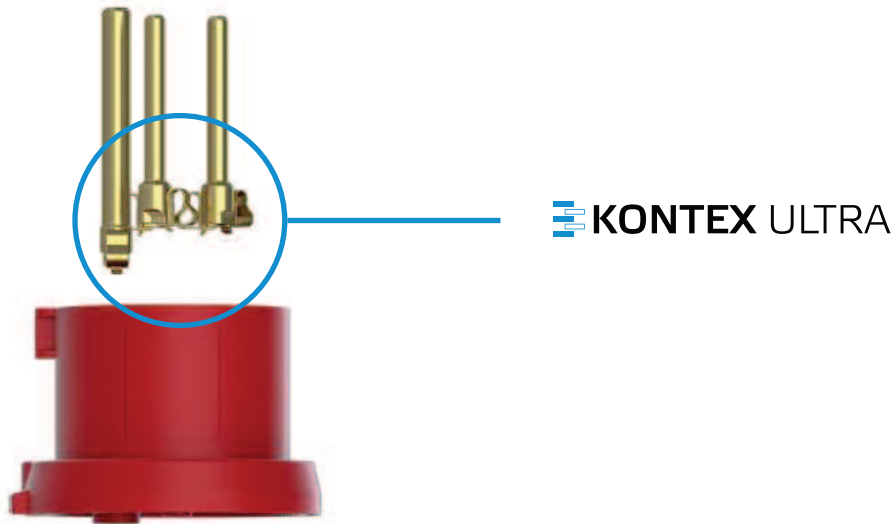



QUICK CONNECT

QUICK-CONNECT De klassieker - nu nog beter. Dankzij de verbeterde QUICK-CONNECT technologie een gegarandeerd optimale en snelle aansluiting van de aders.



Trillingbestendig

QUICK-CONNECT is ongevoelig voor schokken, trillingen en temperatuurschommelingen. Dankzij de veerverbindingstechnologie doorstaat de aansluiting van de aders in de veerklemmen zelfs de meest veeleisende trillingstests van onafhankelijke testinstituten.



Grotere contactoppervlakken

De nieuw ontworpen veerklem heeft een speciaal gevormde drukhoek. Het contactoppervlak wordt hierdoor met bijna 70% vergroot. Dit zorgt voor een veel betere verbinding tussen de ader en de veerklem.



Veilige verbinding

INNOLINQ met QUICK-CONNECT garandeert een veilige en absoluut gecontroleerde aansluiting van de aders en is ongevoelig voor trillingen en temperatuurschommelingen dankzij de nieuwe veerklemverbinding. De klem sluit zichtbaar en hoorbaar met een vingertip - absoluut betrouwbaar en permanent.



Onderhoudsvrij

QUICK-CONNECT is volledig onderhoudsvrij. De contactdruk van de veer is optimaal ingesteld en altijd constant. De klemming van de ader garandeert zo een optimale verbinding gedurende de hele levensduur. Frequentie inspecties zoals bij schroefcontacten zijn niet nodig.



Voor alle koperen aders

De schroefloze QUICK-CONNECT veerklem is bij levering open en is geschikt voor alle soorten en kwaliteiten koperen aders, ongeacht de diameter van de ader en de isolatie ervan. Star, flexibel, met of zonder adereindhulzen - de klem accepteert alle koperen aders.

De volgende aderdoorsneden kunnen worden gebruikt in de QUICK-CONNECT contactmaterialen:

QUICK-CONNECT stekers en koppelingen 16A:	1 mm ² - 2,5 mm ²	(flexibele aders)
QUICK-CONNECT opbouw- en wandcontactdozen 16A:	1,5 mm ² - 4 mm ²	(massieve en meeraderige aders)
QUICK-CONNECT stekers en koppelingen 32A:	2,5 mm ² - 10 mm ²	(flexibele aders)
QUICK-CONNECT opbouw- en wandcontactdozen 32A:	2,5 mm ² - 10 mm ²	(massieve en meeraderige aders)
QUICK-CONNECT stekers en koppelingen 63A:	6 mm ² - 16 mm ²	(flexibele aders)
QUICK-CONNECT opbouw- en wandcontactdozen 63A:	6 mm ² - 25 mm ²	(massieve en meeraderige aders)



Steek de gestripte ader in de open klemmen en sluit deze met een klik



Eenvoudig openen van de klem met een standaard schroevendraaier.



KONTEX ULTRA

Loodvrij, extra stabiel, gepatenteerd en in overeenstemming met REACH & RoHS - dat is de nieuwe KONTEX-ULTRA verbindingstechnologie van Bals. KONTEX-ULTRA werd ontwikkeld onder de titel "Green-Connect" als bijzonder duurzaam en toekomstgericht product.



Reach & RoHS compliant

INNOLINQ voldoet, met de loodvrije KONTEX-ULTRA contacten, nu al aan toekomstige strenge REACH- en RoHS-richtlijnen van de EU.



Verminderde insteek- en uittrekkkrachten

Gladde oppervlakten op de pen en een geoptimaliseerd hulsontwerp verminderen de insteek- en uittrekkkrachten bij het inbrengen en uit elkaar trekken van onze INNOLINQ contactmaterialen. Bovendien maakt de grotere pasnauwkeurigheid het hanteren aanzienlijk eenvoudiger.



Kies voor duurzaamheid

INNOLINQ contactmaterialen zijn loodvrij en grondstoffen besparend gemaakt van recyclebare materialen.



Beter geleidingsvermogen

Onze INNOLINQ producten garanderen een optimaal contact en geleidingsvermogen. Dit wordt gegarandeerd door een speciaal ontwikkeld basismateriaal in combinatie met een zeer complexe hardingstechniek van de KONTEX-ULTRA contacten.



Een speciaal basismateriaal en zeer complex verstevigde contacten verbeteren de geleidbaarheid.



KONTEX-ULTRA is verkrijgbaar in 16A en 32A versies.



MULTI GRIP

De beproefde MULTI-GRIP schroefloze wartel is nu ook geschikt voor nog grotere kabeldoorsneden.



Geïntegreerde trekcontlasting

De universele MULTI-GRIP wartel klemt een grote verscheidenheid aan kabeldiameters vast en sluit hermetisch af. Gewoon met de hand aandraaien, klaar. Het MULTIGRIP-systeem fixeert de kabel en biedt tegelijkertijd een veilige trekcontlasting - zonder de kabel te beschadigen.



Minimaal IP67

De MULTI-GRIP wartels bereiken minimaal beschermingsklasse IP67. De wartel sluit zich na aandraaien met de hand, volledig om de ingevoerde kabel en voorkomt dat water of vuil binnendringt, zelfs niet bij bewegingen van de kabel.



Hoogste treksterkte

De treksterkte van de MULTI-GRIP wartel overtreft vele malen de waarden die worden vereist door de normen NEN-EN-IEC 60309 en VDE 0623. De conditiecontrole en het eventuele onderhoud van de trekcontlasting is op elk moment van buitenaf mogelijk zonder het contactmateriaal te openen.



Grotere kabeldiameters

We hebben de kabelinvoeren van de INNOLINQ contactmaterialen volledig opnieuw ontworpen om nog meer flexibiliteit in de toepassingsmogelijkheden te bieden. Het overtuigende resultaat: er kunnen nu zelfs nog grotere kabeldiameters worden gebruikt dan voorheen.

De volgende kabeldiameters kunnen in de MULTI-GRIP worden gestoken:

TE en TE-Plus contactmaterialen	Kabeldiameter	TLS- en INNOLINQ contactmaterialen	Kabeldiameter
16A 3- en 4-polig TE en TE-Plus	Ø8 mm - Ø18 mm	TLS 16A 3 tot 5-polig	Ø8 mm - Ø18 mm
16A 5-polig TE en TE-Plus	Ø10 mm - Ø21 mm	TLS 32A 3 tot 5-polig	Ø11 mm - Ø23 mm
32A 3- en 4-polig TE en TE-Plus	Ø11 mm - Ø23 mm	INNOLINQ 16A 3-polig	Ø7 mm - Ø18 mm
32A 5-polig TE en TE-Plus	Ø13 mm - Ø27 mm	INNOLINQ 16A 4 en 5-polig	Ø8 mm - Ø21 mm
63A 3 tot 5-polig TE en TE-Plus	Ø16 mm - Ø36 mm	INNOLINQ 32A 3 tot 5-polig	Ø11 mm - Ø29 mm
125A 3 tot 5-polig TE	Ø26 mm - Ø50 mm		

Voor alle 16A contactmaterialen is een verloopstuk type 29129 verkrijgbaar. Hierdoor kunnen ook kabeldiameters kleiner dan Ø8 mm goed worden afgesloten.



Het MULTI-GRIP-systeem fixeert kabels met verschillende doorsneden en biedt een krachtige en veilige trekcontlasting.



Meer flexibiliteit doordat de kabelinvoeren nu geschikt zijn voor nog grotere kabeldoorsneden.

Ik zat direct op
één lijn met Bals

Amir | Installateur

**Als je contact maakt,
doe het dan goed**



**Kies voor VARIABOX met
recyclebare en loodvrije
QUICK-CONNECT
CEE-contactdozen**



Scan de QR code
of ga naar www.bals.nl
voor meer informatie

VARIABOX

Duurzaam verbonden met VARIABOX

De robuuste VARIABOX wandverdelers van Bals hebben recyclebare, loodvrije QUICK-CONNECT CEE-contactdozen. Dat maakt VARIABOX dé duurzame wandverdeler voor industrie, magazijn, werkplaats en andere plekken waar de omstandigheden veeleisend zijn. VARIABOX is verkrijgbaar in beschermingsklassen IP44, IP54 en IP67 en gemaakt van het superieure PBT Polyester. Je voelt het direct als je er een in je handen krijgt: dit is topkwaliteit. Door zijn veelzijdigheid is voor elke situatie een VARIABOX configuratie samen te stellen. Met de duurzame VARIABOX wandverdelers van Bals ben je: Simply. Well. Connected.

Doordacht design

Het doordachte design van de VARIABOX garandeert optimaal gebruiksgemak en bedrijfszekerheid. Zo opent het klapdeksel van de ruimte met ABB beveiligingscomponenten, naar boven. Daardoor kan er geen stof of (condens-) water naar binnen komen als het klapvenster geopend is. Het klapdeksel is uitgerust met de One Touch Close (OTC) techniek. Na ontgrendelen klapt het venster vanzelf open. Met een kort tikje op de deksel, sluit deze ook geheel vanzelf.

Maatwerkoplossing

VARIABOX wandverdelers zijn volledig naar wens samen te stellen. Voor elke situatie is een passende configuratie met de VARIABOX mogelijk. Naast Schuko of CEE-contactdozen met QUICK-CONNECT, biedt de VARIABOX ook verschillende beveiligingsmogelijkheden, contactdozen voor RJ45, HDMI of USB contacten en afschakelbare en vergrendelbare contacten. In Nederland worden de VARIABOXEN geassembleerd en getest in onze werkplaats in Haarlem.

Neem contact op met team Bals Nederland voor een maatwerk advies: +31-(0)23 547 09 47 of mail naar verkoop@bals.nl.



De afbeelding toont de plaats van de uurstanden, voltages en frequenties voor een contactdoos (vooraanzicht) met nominale netspanningen boven 50 V volgens DIN EN 60309-2. Steker en contactdoos zijn spiegelbeelden van elkaar.

- 1) Hoofdzakelijk voor scheepsinstallatie.
- 2) Alleen voor koelcontainers (gestandaardiseerd door ISO).
- 3) Beschermend aardcontact vereist.

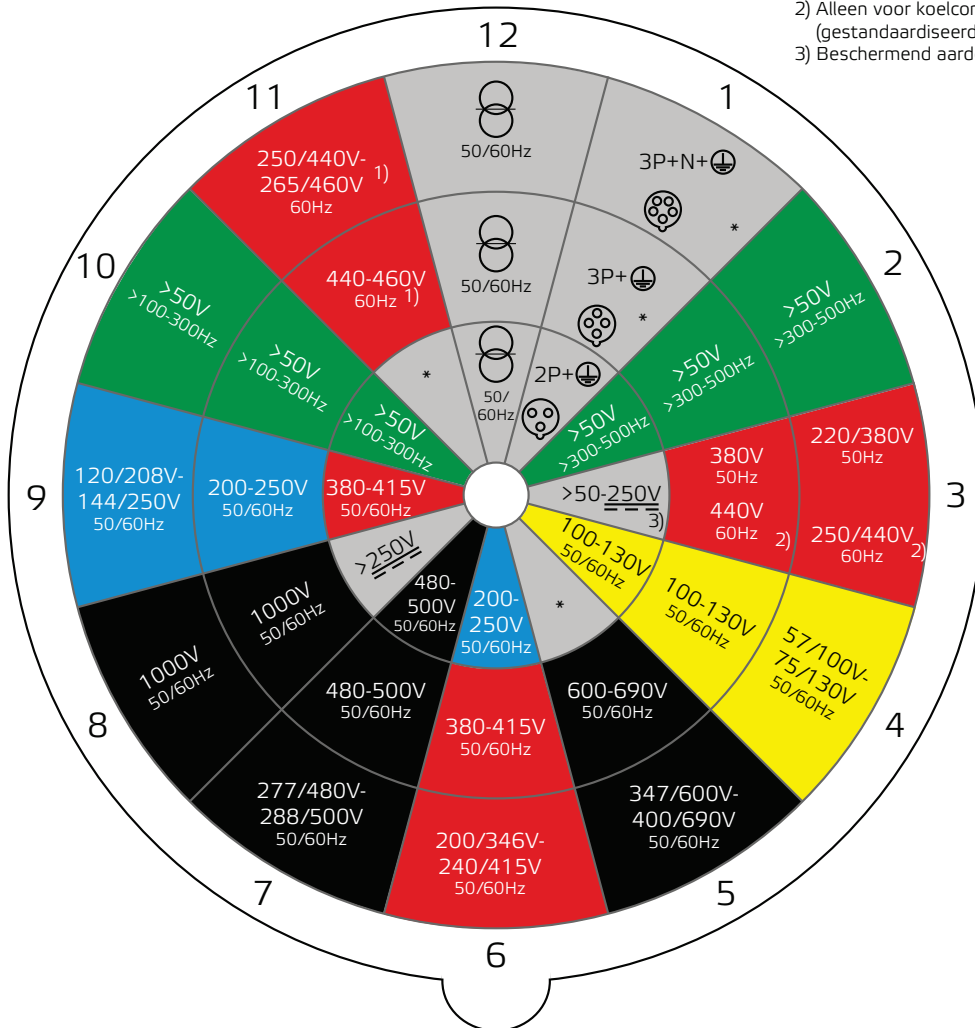

Voeding na een scheidingstransformator

Gelijkstroom DC







* Alle nominale netspanningen en/of frequenties die niet onder een andere regeling vallen. Deze uurstanden kunnen bovendien worden gebruikt in speciale toepassingen.

Positie van de hulplip ten opzichte van de basislip voor verschillende spanningen tot 50 V en frequenties tot 500 Hz volgens NEN-EN-IEC 60309-2.

Aantal polen	Frequentie	Nominale netspanning	Positie van de hulplip	Identificatiekleur
2-, 3pol.	50 en 60 Hz	20 - 25 V	zonder	violet
	50 en 60 Hz	40 - 50 V	12 h	wit
	100 - 200 Hz	40 - 50 V	4 h	groen
	300 Hz	20 - 25 V 40 - 50 V	2 h	groen
	400 Hz	20 - 25 V 40 - 50 V	3 h	groen
	meer dan 400 - 500 Hz	20 - 25 V 40 - 50 V	11 h	groen
			tot 50 V	10 h

Identificatie kleuren

Als de netspanning wordt aangeduid door identificatiekleuren naast de voorgeschreven opschriften, moet bij voorkeur de kleurcode van de volgende tabel worden gebruikt:

Nominale netspanning of frequentie	Identificatiekleur
20 - 25 V	violet 
40 - 50 V	wit 
100 - 130 V	geel 
200 - 250 V	blauw 
380 - 460 V	rood 
500 - 690 V	zwart 
boven 60-500 Hz	groen 

Contactopstelling voor CEE-stekers en -contactdozen

Groter dan 50 V:

Tot 50 V:

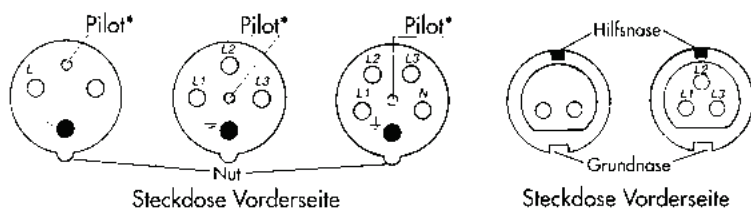

* nur bei 63 A und 125 A

Etikettering van de aderaansluitingen

De aansluitingen moeten worden gemarkeerd met de volgende symbolen: L1, L2, L3 of 1, 2, 3 voor de buitenader.

De nul-ader is gemarkeerd met N en het aardcontact met 

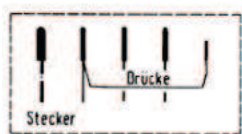
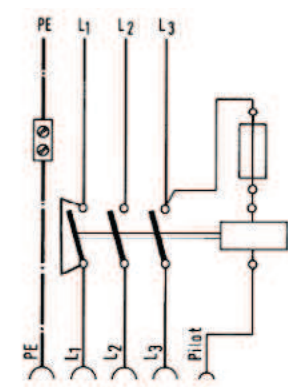

schakelschema van een actief Pilot-contact. (afbeelding 1)

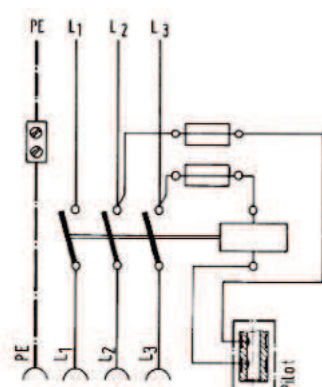

schakelschema van een PSK: passief Pilot-contact (afbeelding 2)

Pilot-contact (P) versus Pilot-schakelcontact (PSK) bij contactdozen



















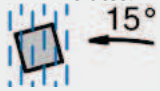



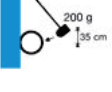





Pilot-contacten zijn geïntegreerde actieve bedieningselementen in CEE-contactdozen met een nominale stroom van 63 of 125A. Het voordeel van het gebruik van een pilot-contact is dat deze altijd (Last-on | First-off) contact maken. Hiermee kunt u voorkomen dat er onder vollast verbinding wordt gemaakt of verbroken. Er zijn twee varianten pilot-contact: actief en passief.

Afbeelding 1 toont een schakelschema van een actief pilot-contact, ook wel aangeduid als een pilot-contact. Bij een pilot-contact wordt in de steker een brug naar een fase of nul gemaakt. Hierdoor wordt (zie afbeelding 1) een contactor geactiveerd.

Een passief pilot-contact wordt een PSK (Pilot-schakel-contact) genoemd. Bij een PSK (afbeelding 2) wordt de pen in de steker alleen gebruikt om het hulpcontact (NO) in de wandcontactdoos mechanisch te bedienen. Hierdoor kan er potentiaal vrij geschakeld worden in een hulpcircuit. De wandcontactdozen met een (PSK) contact zijn standaard uitgerust met 2 flexibele geleiders. Alle contactdozen 63 en 125A kunnen met een Pilot contact besteld worden. Hiervoor dient u een P achter het artikelnummer te plaatsen.

IP-beschermingsgraden voor behuizingen volgens NEN-EN-IEC 60529 (DIN VDE 0470)

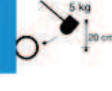
IK-code volgens NEN-EN-IEC 62262 (VDE 0470)

1. Codenummer	Bescherming van de behuizing tegen het binnendringen van	Bescherming tegen contact met	2. Codenummer	Bescherming van de behuizing tegen schadelijke effecten van	Codenummer	Slagvastheid
0	niet beschermd 	niet beschermd 	0	niet beschermd 	0	niet beschermd volgens norm
1	vaste deeltjes groter dan 50mm 	oppervlakkige handaanraking 	1	verticaal vallend druppelend water 	01	Energie 0,140 Joule 
2	vaste deeltjes groter dan 12,5mm 	vingeraanraking 	2	druppelend water tot een hoek van 15° verticaal 	02	Energie 0,200 Joule 
3	vaste deeltjes groter dan 2,5 mm 	gereedschap 	3	sproeiwater tot een hoek van 60° verticaal 	05	Energie 0,700 Joule 
4	vaste deeltjes groter dan 1 mm 	draad 	4	spatwater uit alle richtingen 	06	Energie 1 Joule 
5	schadelijke stofafzettingen (aanrakingsveilig) 	draad 	5	waterstralen uit alle richtingen 	07	Energie 2 Joule 
6	stofdicht (volledige bescherming) 	draad 	6	sterke waterstralen 	08	Energie 5 Joule 
			7	onderdompeling onder gespecificeerde druk en tijdsomstandigheden 	09	Energie 10 Joule 
			8	onderdompeling onder vaste druk en voor onbepaalde tijd* 	10	Energie 20 Joule 

Voorbeeld IP67:
 6 - stofdicht (volledige bescherming)
 7 - bescherming tijdens onderdompeling onder gespecificeerde druk- en tijdsomstandigheden

* Voorwaarden worden bepaald tussen fabrikant en gebruiker. Aanscherping van de testvoorwaarden ten opzichte van codenummer 7.

Alle Bals contactmaterialen zijn:

Slagvast, zelfs bij extreme temperaturen

getest van -25°C tot +40°C

Vormvast, ook bij hoge temperaturen

gloeidraadtest met 650°C resp. 850°C

Spatwaterdicht, waterdicht en stofdicht volgens beschermingsklassen IP44, IP54 of IP67

tests volgens DIN EN 60529, onder andere in 1 m waterdiepte

Bestendig tegen intensief gebruik

de contactmaterialen worden getest onder mechanische, elektrodynamische en thermische continue belasting

Bestand tegen veroudering

langetermijntest bij een temperatuur van 80°C

Goed isolerend

de gebruikte kunststof onderdelen isoleren spanningen van $\geq 2500V\sim$

Vormvast en slijtvast

getest door jarenlang gebruik in veeleisende bedrijfsomgevingen

Milieuvriendelijk

de stekers en contactdozen zijn cadmiumvrij, INNOLINQ en CEE-contactdozen 16A/32A zijn bovendien recyclebaar en loodvrij.

Voor de verdeelkasten geldt over het algemeen hetzelfde als voor de contactmaterialen, met speciale aandacht voor chemische bestendigheid. De verdeelkasten van hoogwaardig kunststof en massief rubber zijn geschikt voor de meeste toepassingen. Als er chemicaliën worden gebruikt, bijvoorbeeld voor schoonmaakwerkzaamheden in voedselverwerkende fabrieken, kan het nodig zijn om een ander materiaal te gebruiken (zie de lijst met materiaalbestendigheid op pagina 20) of neem contact met ons op.



Gloeidraadtest



Producttest bij -25°C

Materiaalbestendigheidslijst











Deze lijst bevat de meest voorkomende chemicaliën. Het geeft informatie over de basisbestendigheid van onze productmaterialen in combinatie met chemicaliën. Er moet voornamelijk rekening worden gehouden met de concentratie van de chemicaliën en de omgevings-temperatuur. Als andere of gelijktijdig voorkomende chemicaliën worden gebruikt, moet een nauwkeurige controle van de bestendigheid worden uitgevoerd.

■ bestendig □ voorwaardelijk bestendig □ niet bestendig

	Polyamide	Polycarbonaat	Polyester	Rubber
Aceton	■	□	□	■
Alcohol (ethylalcohol)	■	■	■	■
alcoholische dranken	■	■	■	■
Ammoniak waterig	■	□	■	■
Benzine	■	■	■	□
Benzeen	■	□	□	□
Broom	□	□	□	□
Boter	■		■	□
Chloor	□	□	□	□
Dieselolie – Stookolie	■	□	■	□
Dichloormethaan	□	□	□	□
Azijnzuur 10%	□	■	□	□
Ethylether	■	□	■	□
Fluorkoolwaterstoffen	■	□	■	□
Vruchtensappen	□	■	■	■
Afwasmiddel	□	□	■	■
Glycerine	■	□	■	■
Glycol	□	□	■	■
Ureum	□	□	■	■
Jodium	□	□	□	■
Vloeibare zeepoplossing, 2%	■	■	■	■
Methanol	□	□	■	■
Melk	■	■	■	■
Minerale oliën, vetten	■	■	■	□
Nitrobenzeen	■	□	□	□
Ozon	□	■	□	□
Perchloorethyleen	□	□	■	□
Zoutzuur tot 35%	□	□	□	□
Zwavelzuur tot 40%	□	■	□	■
Reuzel	■	□	■	□
Zeepoplossing waterig	■	■	■	□
Eetbare oliën, vetten	■	■	■	□
Superbenzine, aromatenhoudend	■	□	□	□
Tolueen	■	□	□	□
Trichloorethyleen	□	□	□	□
Wasmiddellogen	■	□	■	□
Water, zeewater, koud	■	■	■	■
Water, heet	□	□	□	□
Waterstofsuperoxide, sterkte 30%	□	■	□	□

Bron: Werkstoff-Führer Kunststoff, Hellerich/ Harsch/ Haenle - 6e editie, Bayer Bayer Kunststoff

Meest gebruikte materialen en eigenschappen van Bals CEE-stekers en contactdozen

	Verbindingstechnologie	Materiaal contact-drager	Materiaal contact-materiaal	Materiaal behuizing	Deksel klinknagel	Materiaal montageschroef (schroeven)	Materiaal contactschroef (schroeven)
Steker TLS	Schroefaansluiting	PA6	Messing	PA6	-	Staal blauw verzinkt	Staal vernikkeld
Steker Standaard	 QUICK CONNECT	PA6	Messing	PA6	-	-	-
Steker TE	Schroefklem	PA6.6	Messing vernikkeld	PA6	-	RVS A2	Staal vernikkeld
Steker TE-Plus	 QUICK CONNECT	PA6.6	Messing vernikkeld	PA6	-	RVS A2	-
Koppeling TLS	Schroefaansluiting	PA6	Messing	PA6	Messing	Staal blauw verzinkt	Staal vernikkeld
Koppeling Standaard	 QUICK CONNECT	PA6	Messing	PA6	Messing	-	-
Koppeling TE	Schroefaansluiting	PA6.6	Messing vernikkeld	PA6	RVS A2	RVS A2	Staal vernikkeld
Koppeling TE-Plus	 QUICK CONNECT	PA6.6	Messing vernikkeld	PA6	RVS A2	RVS A2	-
Wandcontactdoos Standaard	 QUICK CONNECT	1)	2)	3)	Messing	4)	-
Wandcontactdoos TE	 QUICK CONNECT	PA6.6	Messing vernikkeld	3)	RVS A2	RVS A2	-
Opbouwcontactdoos Standaard	 QUICK CONNECT	1)	2)	PA6	Messing	-	-
Opbouwcontactdoos TE	 QUICK CONNECT	PA6.6	Messing vernikkeld	PA6	RVS A2	-	-
Toestelcontactdoos	 QUICK CONNECT	1)	2)	PA6	-	-	-
Toestelcontactdoos TE	 QUICK CONNECT	PA6.6	Messing vernikkeld	PA6	-	-	-

1) 16 + 32A van PA6
63A gemaakt van PA6.6

2) 16 + 32A messing
63A messing vernikkeld

3) 16 + 32A van PA6
63A van PC

4) 16 + 32A staal blauw verzinkt,
63A RVS A2

PA6 (polyamide) en PC (polycarbonaat) zijn hoogwaardige kunststoffen die voornamelijk worden gebruikt voor contactmaterialen en combinaties. PA6.6 (polyamide met glasvezel) is een hoogwaardige kunststof die vooral wordt gekenmerkt door zijn hoge hittebestendigheid.

Uittrekrachten voor het MULTI-GRIP wartelsysteem

Steker/koppeling	Kabel ø	Koppel		Trekkracht min. Volgens NEN-EN-IEC 60309	Gemeten trekkracht *
		min.	max.		
16A 3 en 4 polen	8 mm	4 Nm	7 Nm	80 N	85 N
16A 3 en 4 polen	18 mm	4 Nm	7 Nm	80 N	200 N
16A 3 en 4 polen	< 7 mm	4 Nm	7 Nm	met verloopstuk type 29129	300 N
16A 5 polig TLS en QC	8 mm	4 Nm	7 Nm	80 N	85 N
16A 5 polig TLS en QC	18 mm	4 Nm	7 Nm	80 N	200 N
16A 5 polig TE	10 mm	4 Nm	7 Nm	80 N	400 N
16A 5 polig TE	21 mm	4 Nm	7 Nm	80 N	600 N
32A 3 en 4 polen	11 mm	4,5 Nm	9 Nm	100 N	400 N
32A 3 en 4 polen	23 mm	4,5 Nm	9 Nm	100 N	600 N
32A 5 polig TLS en QC	11 mm	4,5 Nm	9 Nm	100 N	400 N
32A 5 polig TLS en QC	23 mm	4,5 Nm	9 Nm	100 N	600 N
32A 5-polig TE	13 mm	5 Nm	9,5 Nm	100 N	350 N
32A 5-polig TE	27 mm	5 Nm	9,5 Nm	100 N	550 N
63A 3 - 5 pol.	24 mm	7,5 Nm	20 Nm	120 N	1900 N
63A 3 - 5 pol.	27 mm	7,5 Nm	20 Nm	120 N	2000 N
125A 3 - 5 pol.	36 mm	10 Nm	22 Nm	200 N	2700 N
125A 3 - 5 pol.	41 mm	10 Nm	22 Nm	200 N	2200 N

* Gemeten trekkracht: kamertemperatuur 20°C, testmachine type TIRA test 2710/1







Rubberen kabel: H07RN-F Niet-bindende richtwaarden. Technische wijzigingen voorbehouden.

1

CONTACTDOZEN



CEE-wandcontactdozen

<p>CEE-wandcontactdozen IP44</p>  <p>Pagina 25</p>	<p>CEE-wandcontactdozen IP67</p>  <p>Pagina 27</p>	<p>CEE-wandcontactdozen TK-combinatie</p>  <p>Pagina 30</p>	<p>CEE-wandcontactdozen TE IP44</p>  <p>Pagina 32</p>	<p>CEE-wandcontactdozen TE IP67</p>  <p>Pagina 34</p>	<p>CEE-wandcontactdozen met pilotcontact</p>  <p>Pagina 36</p>
---	---	--	--	--	---

CEE-wandcontactdozen, afschakelbaar-vergrendelbaar-beveiligd

<p>CEE-wandcontactdozen beveiligd IP44</p>  <p>Pagina 38</p>	<p>CEE-wandcontactdozen beveiligd IP67</p>  <p>Pagina 40</p>	<p>CEE-wandcontactdozen afschakelbaar vergrendelbaar IP44</p>  <p>Pagina 42</p>	<p>CEE-wandcontactdozen afschakelbaar vergrendelbaar IP67</p>  <p>Pagina 43</p>	<p>CEE-wandcontactdozen afschakelbaar vergrendelbaar beveiligd IP44</p>  <p>Pagina 45</p>	<p>CEE-wandcontactdozen afschakelbaar vergrendelbaar beveiligd IP67</p>  <p>Pagina 47</p>
---	---	--	--	--	--

CEE-wandcontactdozen ZO, afschakelbaar-vergrendelbaar-beveiligd

<p>CEE-wandcontactdozen afschakelbaar vergrendelbaar zware omstandigheden IP67</p>  <p>Pagina 48</p>

CEE-inbouwcontactdoos

<p>CEE-inbouwcontactdozen recht IP44</p>  <p>Pagina 49</p>	<p>CEE-inbouwcontactdozen schuin IP44</p>  <p>Pagina 51</p>	<p>CEE-inbouwcontactdozen recht IP67</p>  <p>Pagina 54</p>	<p>CEE-inbouwcontactdozen schuin IP67</p>  <p>Pagina 56</p>	<p>CEE-inbouwcontactdozen met hulpcontact of pilotcontact</p>  <p>Pagina 59</p>	<p>CEE-inbouwcontactdozen TE IP44</p>  <p>Pagina 60</p>
---	--	---	--	--	--

<p>CEE-inbouwcontactdozen TE IP67</p>  <p>Pagina 62</p>
--

Technische kenmerken

**INNOLINQ met KONTEX ULTRA loodvrij**

- INNOLINQ met KONTEX-ULTRA loodvrij voldoet nu al aan toekomstige strenge REACH- en RoHS-richtlijnen van de EU
- gladde oppervlakken op de pen en een geoptimaliseerd hulsontwerp verminderen de insteek- en uittrekkrachten
- het volledig recyclebare basismateriaal garandeert optimaal contact en heeft een verbeterde geleidbaarheid

**Schroefloze QUICK CONNECT aansluitklemmen 16A en 32A**

- Ongevoelig voor trillingen en temperatuurschommelingen dankzij de unieke veerverbindingstechnologie van Bals. Onderhoudscontroles voor loslatende schroefjes zijn dan ook verleden tijd
- alle QUICK-CONNECT contactdozen zijn aanraakveilig
- geen adereindhulzen nodig
- als je met je vinger op de contactschuif drukt, wordt de veerklem gesloten
- betrouwbare en permanente verbinding dankzij trekverentechnologie
- de afgeschermdde trekveren garanderen een optimale verbinding over de gehele levensduur
- herbedrading zonder verdere aderbehandeling
- recyclebaar en loodvrij

**Wandcontactdozen INNOLINQ**

- schroefloze verbindingstechnologie QUICK-CONNECT
- kabelinvoer eenmaal boven (open) en eenmaal onder (gesloten)
- beschermingsklasse IP44
- hittebestendige contactdragers
- recyclebaar en loodvrij

**HKS-opbouwcontactdozen, elegante bediening, regeling, bewaken, controleren**

- extra hulpcontactschakelaar wordt bediend door steker
- beschikbaar op CEE-opbouwcontactdozen incl. 16A en 32A en op contactdozen met randaarde
- vergrendeling elektrische steker mogelijk
- potentiaalvrij schakelen
- schakelcontact kan afzonderlijk worden aangesloten

CEE-wandcontactdoos

- Schroefloze aansluittechniek
- Kabelinvoer één keer boven (open) en één keer onder (gesloten)
- Beschermingklasse IP44
- Hittebestendige contactdragers
- Recyclebaar en loodvrij



110635

		110V 50-60 Hz	230V 50-60 Hz	400V 50-60 Hz	500V 50-60 Hz	>50V 301-500Hz	>50V 100-300Hz	kg
		3pol 4pol 5pol 4h 4h 4h	3pol 4pol 5pol 6h 9h 9h	3pol 4pol 5pol 9h 6h 6h	3pol 4pol 5pol 7h 7h 7h	3pol 4pol 5pol 2h 2h 2h	3pol 4pol 5pol 10h 10h 10h	Gewicht
16	5	110624						0.264
32	5	110635						0.353

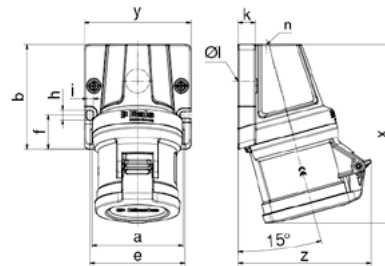

Ampere Polzahl	16 5	32 3	32 4	32 5
a	80,0	80,0	80,0	80,0
b	92,0	92,0	92,0	92,0
e	84,0	84,0	84,0	84,0
f	30,0	30,0	30,0	30,0
h	9,0	9,0	9,0	9,0
i	5,5	5,5	5,5	5,5
k	15,0	15,0	15,0	15,0
ø l	21,0	21,0	21,0	21,0
n	M32	M32	M32	M32
x	145,0	157,0	157,0	158,0
y	94,0	94,0	94,0	94,0
z	114,0	112,0	112,0	118,0
Cond. mm² min	1,0	2,5	2,5	2,5
Cond. mm² max	4,0	10,0	10,0	10,0

CEE-wandcontactdoos

- Schroefloze klemmen
- KONTEX contact
- Kabelinvoer één keer boven (open), één keer onder en één keer achter (gesloten)
- Behuizingbodem 180 gr draaibaar
- Beschermingklasse IP44

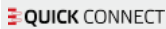

11906

		110V 50-60 Hz	230V 50-60 Hz	400V 50-60 Hz	500V 50-60 Hz	>50V 301-500Hz	>50V 100-300Hz	kg
		3pol 4pol 5pol 4h 4h 4h	3pol 4pol 5pol 6h 9h 9h	3pol 4pol 5pol 9h 6h 6h	3pol 4pol 5pol 7h 7h 7h	3pol 4pol 5pol 2h 2h 2h	3pol 4pol 5pol 10h 10h 10h	Gewicht
16	3	11928	11930	11931	11932	11934	11933	0.181
16	4	11907					11936	0.238
16	5	11906						0.272

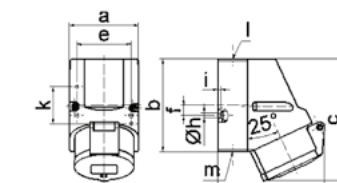

1 MB 7

Ampere Polzahl	16 3	16 4	16 5
a	64,0	75,0	75,0
b	87,0	100,0	100,0
c	117,0	129,0	131,0
d	103,0	108,0	116,0
e	51,0	59,0	59,0
f	-	11,0	11,0
h ø	4,1	5,1	5,1
i	4,5	4,5	4,5
k	40,0	-	-
l	M20	M20	M20
m	für M20	für M20	für M20
Leiter mm² min	1,5	1,5	1,5
Leiter mm² max	4	4	4

CEE-wandcontactdoos

- Schroefloze klemmen
- KONTEX contact
- Kabelinvoer één keer boven (open), twee keer onder (gesloten)
- Behuizingbodem 180 gr draaibaar
- Beschermingklasse IP44



11909

		110V 50-60 Hz	230V 50-60 Hz	400V 50-60 Hz	500V 50-60 Hz	>50V 301-500Hz	>50V 100-300Hz	kg
		3pol 4pol 5pol 4h 4h 4h	3pol 4pol 5pol 6h 9h 9h	3pol 4pol 5pol 9h 6h 6h	3pol 4pol 5pol 7h 7h 7h	3pol 4pol 5pol 2h 2h 2h	3pol 4pol 5pol 10h 10h 10h	Gewicht
16	4	11944					11945	0.297
16	5	11909					11947	0.340
32	3	11949						0.340
32	4	11955	11956	11957		110073	0.359	
32	5	11960	110322	11962	11963		0.395	

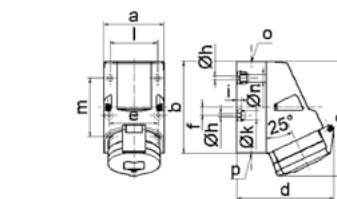

1 MB 2

Ampere Polzahl	16 4	16 5	32 3	32 4	32 5
a	83,0	83,0	83,0	83,0	83,0
b	126,0	126,0	126,0	126,0	126,0
c	153,0	155,0	155,0	155,0	155,0
d	127,0	130,0	130,0	130,0	136,0
e	68,0	68,0	68,0	68,0	68,0
f	11,0	11,0	11,0	11,0	11,0
h ø	5,5	5,5	5,5	5,5	5,5
i	6,5	6,5	6,5	6,5	6,5
k ø	12,0	12,0	12,0	12,0	12,0
l	65,0	65,0	65,0	65,0	65,0
m	80,0	80,0	80,0	80,0	80,0
n ø	10,0	10,0	10,0	10,0	10,0
o	M25	M25	M25	M25	M25
p	2 x M25	2 x M25	2 x M25	2 x M25	2 x M25
Leiter mm² min	1,5	1,5	2,5	2,5	2,5
Leiter mm² max	4	4	10	10	10

CEE-wandcontactdoos

- Kabelinvoer één keer boven (open, één keer onder (gesloten))
- Behuizingsbodem 180 gr draaibaar
- Vernikkelde contacten
- KONTEX contact
- Raamklemmen
- Beschermingsklasse IP44
- Bij wandcontactdozen schroefklemmen met Pilot graag een -P toevoegen aan het artikelnummer

QUICK CONNECT



1124

		110V 50-60 Hz	230V 50-60 Hz	400V 50-60 Hz	500V 50-60 Hz	>50V 301-500Hz	>50V 100-300Hz	kg
		3pol 4pol 5pol 4h 4h 4h	3pol 4pol 5pol 6h 9h 9h	3pol 4pol 5pol 9h 6h 6h	3pol 4pol 5pol 7h 7h 7h	3pol 4pol 5pol 2h 2h 2h	3pol 4pol 5pol 10h 10h 10h	Gewicht
63	5	110383						0.945

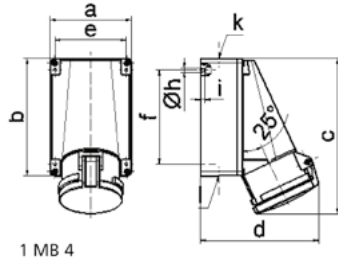

Ampere Polzahl	63 3	63 4	63 5
a	118,0	118,0	118,0
b	170,0	170,0	170,0
c	223,0	223,0	223,0
d	168,0	168,0	168,0
e	104,0	104,0	104,0
f	136,0	136,0	136,0
h ø	6,1	6,1	6,1
i	6,0	6,0	6,0
k	M40	M40	M40
l	M 32/32	M 32/32	M 32/32
Leiter mm² min	6	6	6
Leiter mm² max	25	25	25

CEE-wandcontactdoos

- Kabelinvoer één keer boven (open, één keer onder (gesloten))
- Behuizingsbodem 180 gr draaibaar
- Vernikkelde contacten
- KONTEX contact
- Raamklemmen
- Beschermingsklasse IP44
- Bij wandcontactdozen schroefklemmen met Pilot graag een -P toevoegen aan het artikelnummer



1124

		110V 50-60 Hz	230V 50-60 Hz	400V 50-60 Hz	500V 50-60 Hz	>50V 301-500Hz	>50V 100-300Hz	kg
		3pol 4pol 5pol 4h 4h 4h	3pol 4pol 5pol 6h 9h 9h	3pol 4pol 5pol 9h 6h 6h	3pol 4pol 5pol 7h 7h 7h	3pol 4pol 5pol 2h 2h 2h	3pol 4pol 5pol 10h 10h 10h	Gewicht
63	3	1106	1104	1107		11640		0.780
63	4	1125	1126	1127	1128		11221	0.840
63	5	1129	1130	1124	11208	1108	11429	0.825

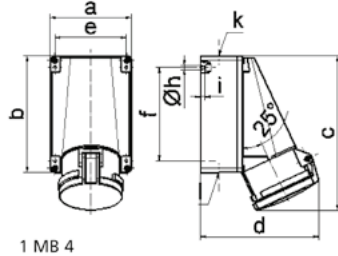

Ampere Polzahl	63 3	63 4	63 5
a	118,0	118,0	118,0
b	170,0	170,0	170,0
c	223,0	223,0	223,0
d	168,0	168,0	168,0
e	104,0	104,0	104,0
f	136,0	136,0	136,0
h ø	6,1	6,1	6,1
i	6,0	6,0	6,0
k	M40	M40	M40
l	M 32/32	M 32/32	M 32/32
Leiter mm² min	6	6	6
Leiter mm² max	25	25	25

CEE-wandcontactdoos

- Schroefklemmen
- Kabelinvoer één keer boven (open), bij 16A één keer, bij 32A twee keer onder (gesloten)
- Behuizingsbodem 180 gr draaibaar
- Beschermingsklasse IP67

	Ampere	Polen	110V	230V	400V	500V	>50V	>50V	kg
			50-60 Hz	50-60 Hz	50-60 Hz	50-60 Hz	301-500Hz	100-300Hz	
			3pol 4pol 5pol	3pol 4pol 5pol	3pol 4pol 5pol	3pol 4pol 5pol	3pol 4pol 5pol	3pol 4pol 5pol	
			4h 4h 4h	6h 9h 9h	9h 6h 6h	7h 7h 7h	2h 2h 2h	10h 10h 10h	
16	3		1132	1133	1134	11320	11027	11350	0.200
16	4		1135	1136	1137	1138	1140	1139	0.262
16	5		1141	1142	1143	11343	11342	11390	0.300
32	3		1144	1145	1146				0.395
32	4		1147	1148	1149	1150	1152	1151	0.412
32	5		1153	1154	1155	11326	11025	11432	0.450



1155

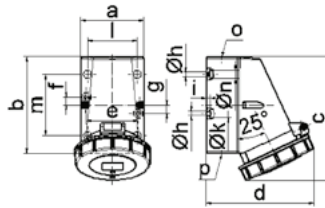

1 MB 13

Ampere Polzahl	16 3	16 4	16 5	32 3	32 4	32 5
a	64,0	75,0	75,0	83,0	83,0	83,0
b	87,0	100,0	100,0	126,0	126,0	126,0
c	115,0	130,0	130,0	160,0	160,0	160,0
d	103,0	110,0	115,0	129,0	129,0	135,0
e	51,0	59,0	59,0	68,0	68,0	68,0
f	20,0	11,0	11,0	11,0	11,0	11,0
g	20,0	-	-	-	-	-
h ø	4,1	5,1	5,1	5,5	5,5	5,5
i	4,5	4,5	4,5	6,5	6,5	6,5
k ø	8,0	10,0	10,0	12,0	12,0	12,0
l	-	-	-	65,0	65,0	65,0
m	-	-	-	80,0	80,0	80,0
n ø	-	-	-	10,0	10,0	10,0
o	M20	M20	M20	M25	M25	M25
p	für M20	für M20	für M20	2 x M25	2 x M25	2 x M25
Leiter mm² min	1,5	1,5	1,5	2,5	2,5	2,5
Leiter mm² max	4	4	4	10	10	10

CEE-wandcontactdoos TE

- Schroefloze klemmen
- KONTEX contact
- Hittebestendig binnenwerk
- Vernikkelde contacten
- Met grote aansluitruimte
- Beschermingsklasse IP67

	Ampere	Polen	110V	230V	400V	500V	>50V	>50V	kg
			50-60 Hz	50-60 Hz	50-60 Hz	50-60 Hz	301-500Hz	100-300Hz	
			3pol 4pol 5pol	3pol 4pol 5pol	3pol 4pol 5pol	3pol 4pol 5pol	3pol 4pol 5pol	3pol 4pol 5pol	
			4h 4h 4h	6h 9h 9h	9h 6h 6h	7h 7h 7h	2h 2h 2h	10h 10h 10h	
16	4				11493				0.420



110094

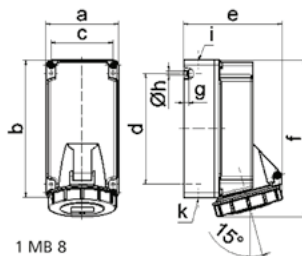

1 MB 8

Ampere Polzahl	16 3	16 4	16 5
a	90,0	90,0	90,0
b	170,0	170,0	170,0
c	77,0	77,0	77,0
d	137,5	137,5	137,5
e	108,0	115,0	122,0
f	191,5	191,5	195,0
g	6,5	6,5	6,5
h ø	5,5	5,5	5,5
i	M20	M20	M20
k	M20/25	M20/25	M20/25
Leiter mm² min	1,5	1,5	1,5
Leiter mm² max	4	4	4

CEE-wandcontactdoos TE

- Schroefloze klemmen
- KONTEX contact
- Hittebestendig binnenwerk
- Vernikkelde contacten
- Met grote aansluitruimte
- Beschermingsklasse IP67

	Ampere	Polen	110V	230V	400V	500V	>50V	>50V	kg
			50-60 Hz	50-60 Hz	50-60 Hz	50-60 Hz	301-500Hz	100-300Hz	
			3pol 4pol 5pol	3pol 4pol 5pol	3pol 4pol 5pol	3pol 4pol 5pol	3pol 4pol 5pol	3pol 4pol 5pol	
			4h 4h 4h	6h 9h 9h	9h 6h 6h	7h 7h 7h	2h 2h 2h	10h 10h 10h	
32	3				11496				0.735
32	4				11461				0.745



110075

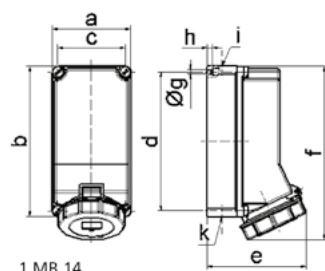

1 MB 14

Ampere Polzahl	32 3	32 4	32 5
a	118,0	118,0	118,0
b	225,0	225,0	225,0
c	101,0	101,0	101,0
d	208,0	208,0	208,0
e	143,0	143,0	149,0
f	255,0	255,0	255,0
g ø	6,5	6,5	6,5
h	8,0	8,0	8,0
i	2xM25	2xM25	2xM25
k	2xM25	2xM25	2xM25
Leiter mm² min	2,5	2,5	2,5
Leiter mm² max	10	10	10

CEE-wandcontactdoos

- Kabelinvoer één keer boven (open, één keer onder (gesloten))
- Vernikkelde contacten
- Behuizingsbodem 180 gr draaibaar
- KONTEX contact
- Raamklemmen
- Beschermingsklasse IP67
- Bij wandcontactdozen schroefklemmen met Pilot graag een -P toevoegen aan het artikelnummer

QUICK CONNECT



1112

	110V 50-60 Hz	230V 50-60 Hz	400V 50-60 Hz	500V 50-60 Hz	>50V 301-500Hz	>50V 100-300Hz	kg
	3pol 4pol 5pol 4h 4h 4h	3pol 4pol 5pol 6h 9h 9h	3pol 4pol 5pol 9h 6h 6h	3pol 4pol 5pol 7h 7h 7h	3pol 4pol 5pol 2h 2h 2h	3pol 4pol 5pol 10h 10h 10h	Gewicht
63	5	110413					1.005

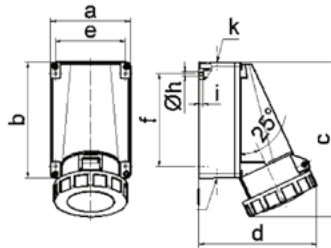

1 MB 3

Ampere	63	63	63			
Polzahl	3	4	5			
a	118,0	118,0	118,0			
b	170,0	170,0	170,0			
c	228,0	228,0	228,0			
d	176,0	176,0	176,0			
e	104,0	104,0	104,0			
f	136,0	136,0	136,0			
h ø	6,1	6,1	6,1			
i	6,0	6,0	6,0			
k	M40	M40	M40			
l	M32/32	M32/32	M32/32			
Leiter mm² min	6	6	6			
Leiter mm² max	25	25	25			

CEE-wandcontactdoos

- Kabelinvoer één keer boven (open, één keer onder (gesloten))
- Vernikkelde contacten
- Behuizingsbodem 180 gr draaibaar
- KONTEX contact
- Raamklemmen
- Beschermingsklasse IP67
- Bij wandcontactdozen schroefklemmen met Pilot graag een -P toevoegen aan het artikelnummer



1112

	110V 50-60 Hz	230V 50-60 Hz	400V 50-60 Hz	500V 50-60 Hz	>50V 301-500Hz	>50V 100-300Hz	kg	
	3pol 4pol 5pol 4h 4h 4h	3pol 4pol 5pol 6h 9h 9h	3pol 4pol 5pol 9h 6h 6h	3pol 4pol 5pol 7h 7h 7h	3pol 4pol 5pol 2h 2h 2h	3pol 4pol 5pol 10h 10h 10h	Gewicht	
63	3	1156	1157	1161			0.840	
63	4	1159	1160	1162			0.850	
63	5	1163	1164	1112	11017	11126	11368	0.900

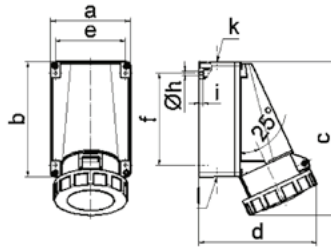

1 MB 3

Ampere	63	63	63			
Polzahl	3	4	5			
a	118,0	118,0	118,0			
b	170,0	170,0	170,0			
c	228,0	228,0	228,0			
d	176,0	176,0	176,0			
e	104,0	104,0	104,0			
f	136,0	136,0	136,0			
h ø	6,1	6,1	6,1			
i	6,0	6,0	6,0			
k	M40	M40	M40			
l	M32/32	M32/32	M32/32			
Leiter mm² min	6	6	6			
Leiter mm² max	25	25	25			

CEE-wandcontactdoos

- Schroefklemmen
- Kabelinvoer één keer M50 boven
- Hittebestendig binnenwerk
- KONTEX contact
- Vernikkelde contacten
- Raamklemmen
- Beschermingsklasse IP67
- Bij wandcontactdozen schroefklemmen met Pilot graag een -P toevoegen aan het artikelnummer



11447

	110V 50-60 Hz	230V 50-60 Hz	400V 50-60 Hz	500V 50-60 Hz	>50V 301-500Hz	>50V 100-300Hz	kg	
	3pol 4pol 5pol 4h 4h 4h	3pol 4pol 5pol 6h 9h 9h	3pol 4pol 5pol 9h 6h 6h	3pol 4pol 5pol 7h 7h 7h	3pol 4pol 5pol 2h 2h 2h	3pol 4pol 5pol 10h 10h 10h	Gewicht	
125	3	11436	11437	11438			1.570	
125	4	11439	11440	11441	11442	11444	11443	2.040
125	5	11445	11446	11447			2.135	

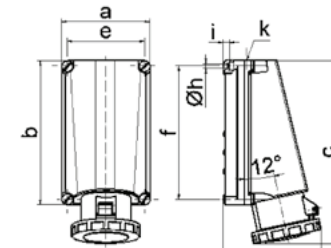

1 MB 20

Ampere	125	125	125			
Polzahl	3	4	5			
a	160,0	160,0	160,0			
b	260,0	260,0	260,0			
c	330,0	330,0	330,0			
d	168,0	168,0	168,0			
e	140,0	140,0	140,0			
f	240,0	240,0	240,0			
h ø	8,3	8,3	8,3			
i	10,0	10,0	10,0			
k	M50	M50	M50			
Leiter mm² min	25	25	25			
Leiter mm² max	70	70	70			

CEE-wandcontactdoos

- Schroefklemmen
- KONTEX contact
- Hittebestendig binnenwerk
- Met grote aansluitruimte
- Beschermingsklasse IP67
- Bij wandcontactdozen schroefklemmen met Pilot graag een -P toevoegen aan het artikelnummer



110V
50-60 Hz

230V
50-60 Hz

400V
50-60 Hz

500V
50-60 Hz

>50V
301-500Hz

>50V
100-300Hz

kg

Gewicht

125	3	11476			3.010
125	4	11477		11478	2.865
125	5	11479			3.185



11479

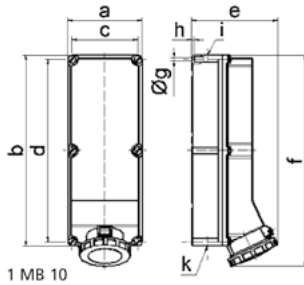

1 MB 10

Ampere	125	125	125			
Polzahl	3	4	5			
a	180,0	180,0	180,0			
b	460,0	460,0	460,0			
c	160,0	160,0	160,0			
d	440,0	440,0	440,0			
e	208,0	208,0	208,0			
f	510,0	510,0	510,0			
g ø	8,3	8,3	8,3			
h	6,5	6,5	6,5			
i	M40	M40	M40			
k	M40/50	M40/50	M40/50			
Leiter mm² min	25	25	25			
Leiter mm² max	70	70	70			

CEE-wandcontactdozen TK-Combinatie

- Schroefloze klemmen
- KONTEX contact
- Om door te lussen
- Hittebestendig binnenwerk
- Vernikkelde contacten
- Beschermingsklasse IP44

QUICK CONNECT



1010

		110V 50-60 Hz	230V 50-60 Hz	400V 50-60 Hz	500V 50-60 Hz	>50V 301-500Hz	>50V 100-300Hz	kg
		3pol 4pol 5pol 4h 4h 4h	3pol 4pol 5pol 6h 9h 9h	3pol 4pol 5pol 9h 6h 6h	3pol 4pol 5pol 7h 7h 7h	3pol 4pol 5pol 2h 2h 2h	3pol 4pol 5pol 10h 10h 10h	Gewicht
16	5	109						0.472

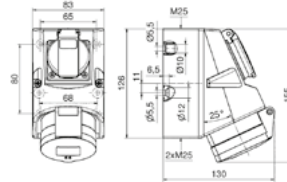

1 MB 122

CEE-wandcontactdozen TK-Combinatie

- Met klemmen, zonder bedrading
- Met geïntegreerd geaard stopcontact 16A/230V~
- Beschermingsklasse IP44



108

		110V 50-60 Hz	230V 50-60 Hz	400V 50-60 Hz	500V 50-60 Hz	>50V 301-500Hz	>50V 100-300Hz	kg
		3pol 4pol 5pol 4h 4h 4h	3pol 4pol 5pol 6h 9h 9h	3pol 4pol 5pol 9h 6h 6h	3pol 4pol 5pol 7h 7h 7h	3pol 4pol 5pol 2h 2h 2h	3pol 4pol 5pol 10h 10h 10h	Gewicht
16	4	1012						0.398
16	5	107						0.438
32	5	108						0.465

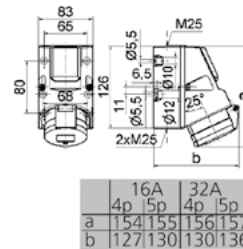

1 MB 17

CEE-wandcontactdozen TK-Combinatie

- Met klemmen, met bedrading (voorbereid, klaar voor aansluiten)
- Met geïntegreerd geaard stopcontact 16A/230V~
- Beschermingsklasse IP44



1013

		110V 50-60 Hz	230V 50-60 Hz	400V 50-60 Hz	500V 50-60 Hz	>50V 301-500Hz	>50V 100-300Hz	kg
		3pol 4pol 5pol 4h 4h 4h	3pol 4pol 5pol 6h 9h 9h	3pol 4pol 5pol 9h 6h 6h	3pol 4pol 5pol 7h 7h 7h	3pol 4pol 5pol 2h 2h 2h	3pol 4pol 5pol 10h 10h 10h	Gewicht
16	4	1013						0.417

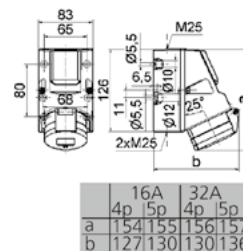

1 MB 17

CEE-wandcontactdoos TE

- Schroefloze klemmen
- KONTEX contact
- Om door te lussen
- Hittebestendig binnenwerk
- Vernikkelde contacten
- Beschermingsklasse IP44

QUICK CONNECT



11990

	Ampere	Polen	110V	230V	400V	500V	>50V	>50V	kg
			50-60 Hz	50-60 Hz	50-60 Hz	50-60 Hz	301-500Hz	100-300Hz	
16	4		11538	11485	11968				0.309
16	5		11972	11487	11973				0.325
32	3		11977	11978	11979				0.365
32	4		11983	11984	11985				0.357
32	5		11989	11990	11991				0.420

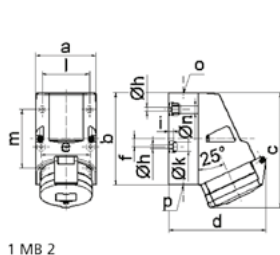

1 MB 2

Ampere Polzahl	16 4	16 5	32 3	32 4	32 5
a	83,0	83,0	83,0	83,0	83,0
b	126,0	126,0	126,0	126,0	126,0
c	153,0	155,0	155,0	155,0	155,0
d	127,0	130,0	130,0	130,0	136,0
e	68,0	68,0	68,0	68,0	68,0
f	11,0	11,0	11,0	11,0	11,0
h ø	5,5	5,5	5,5	5,5	5,5
i	6,5	6,5	6,5	6,5	6,5
k ø	12,0	12,0	12,0	12,0	12,0
l	65,0	65,0	65,0	65,0	65,0
m	80,0	80,0	80,0	80,0	80,0
n ø	10,0	10,0	10,0	10,0	10,0
o	10,0	10,0	10,0	10,0	10,0
p	M25	M25	M25	M25	M25
Leiter mm² min	2 x M25	2 x M25	2 x M25	2 x M25	2 x M25
Leiter mm² max	1,5	1,5	2,5	2,5	2,5
	4	4	10	10	10

CEE-wandcontactdoos TE

- Schroefklemmen
- Hittebestendige contactdragers
- KONTEX contact en raamklemmen
- Vernikkelde contacten
- Beschermingsklasse IP44
- Bij wandcontactdozen met Pilot graag een -P toevoegen aan het artikelnummer



11799

	Ampere	Polen	110V	230V	400V	500V	>50V	>50V	kg
			50-60 Hz	50-60 Hz	50-60 Hz	50-60 Hz	301-500Hz	100-300Hz	
63	3		11796						0.825
63	4			11797	11798				0.885
63	5			11799					0.900

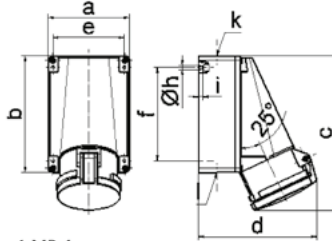

1 MB 4

Ampere Polzahl	63 3	63 4	63 5
a	118,0	118,0	118,0
b	170,0	170,0	170,0
c	223,0	223,0	223,0
d	168,0	168,0	168,0
e	104,0	104,0	104,0
f	136,0	136,0	136,0
h ø	6,1	6,1	6,1
i	6,0	6,0	6,0
k	M40	M40	M40
l	M 32/32	M 32/32	M 32/32
Leiter mm² min	6	6	6
Leiter mm² max	25	25	25

CEE-wandcontactdoos TE

- Schroefloze klemmen
- KONTEX contact
- Om door te lussen
- Hittebestendig binnenwerk
- Vernikkelde contacten
- Beschermingsklasse IP44

QUICK CONNECT



11451

	Ampere	Polen	110V	230V	400V	500V	>50V	>50V	kg
			50-60 Hz	50-60 Hz	50-60 Hz	50-60 Hz	301-500Hz	100-300Hz	
16	3		11448						0.400
16	4		11995	11449	110018				0.675
16	5			11451					0.450

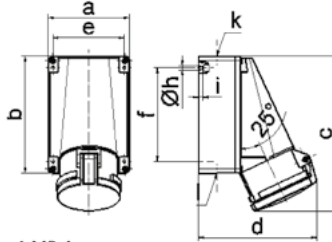

1 MB 4

Ampere Polzahl	63 3	63 4	63 5
a	118,0	118,0	118,0
b	170,0	170,0	170,0
c	223,0	223,0	223,0
d	168,0	168,0	168,0
e	104,0	104,0	104,0
f	136,0	136,0	136,0
h ø	6,1	6,1	6,1
i	6,0	6,0	6,0
k	M40	M40	M40
l	M 32/32	M 32/32	M 32/32
Leiter mm² min	6	6	6
Leiter mm² max	25	25	25

CEE-wandcontactdoos TE

- Schroefloze klemmen
- KONTEX contact
- Om door te lussen
- Hittebestendig binnenwerk
- Vernikkelde contacten
- Beschermingsklasse IP44

QUICK CONNECT



110000

		110V 50-60 Hz	230V 50-60 Hz	400V 50-60 Hz	500V 50-60 Hz	>50V 301-500Hz	>50V 100-300Hz	kg
		3pol 4pol 5pol 4h 4h 4h	3pol 4pol 5pol 6h 9h 9h	3pol 4pol 5pol 9h 6h 6h	3pol 4pol 5pol 7h 7h 7h	3pol 4pol 5pol 2h 2h 2h	3pol 4pol 5pol 10h 10h 10h	Gewicht
32	3	11997						
32	4	11998		11999		110019		0.725
32	5	110000						0.760

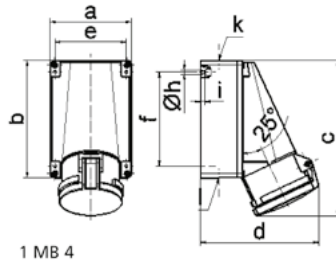

Ampere	63	63	63		
Polzahl	3	4	5		
a	118,0	118,0	118,0		
b	170,0	170,0	170,0		
c	223,0	223,0	223,0		
d	168,0	168,0	168,0		
e	104,0	104,0	104,0		
f	136,0	136,0	136,0		
h ø	6,1	6,1	6,1		
i	6,0	6,0	6,0		
k	M40	M40	M40		
l	M 32/32	M 32/32	M 32/32		
Leiter mm² min	6	6	6		
Leiter mm² max	25	25	25		

CEE-wandcontactdoos TE

- Schroefklemmen
- Doorlusmogelijkheid
- Hittebestendige contactdragers
- KONTEX contact en raamklemmen
- Vernikkelde contacten
- Beschermingsklasse IP44
- Bij wandcontactdozen met Pilot graag een -P toevoegen aan het artikelnummer



11803

		110V 50-60 Hz	230V 50-60 Hz	400V 50-60 Hz	500V 50-60 Hz	>50V 301-500Hz	>50V 100-300Hz	kg
		3pol 4pol 5pol 4h 4h 4h	3pol 4pol 5pol 6h 9h 9h	3pol 4pol 5pol 9h 6h 6h	3pol 4pol 5pol 7h 7h 7h	3pol 4pol 5pol 2h 2h 2h	3pol 4pol 5pol 10h 10h 10h	Gewicht
63	3	11800						1.500
63	4	11801		11802		11803		1.610
63	5	11803						1.660

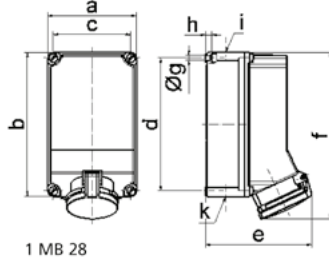

Ampere	63	63		
Polzahl	3/4	5		
a	160,0	160,0		
b	260,0	260,0		
c	140,0	140,0		
d	240,0	240,0		
e	184,0	184,0		
f	302,0	302,0		
g ø	8,1	8,1		
h	10,0	10,0		
i	M40	M40		
k	M32/40	M32/40		
Leiter mm² min	6	6		
Leiter mm² max	25	25		

CEE-wandcontactdoos TE

- Schroefloze klemmen
- KONTEX contact
- Om door te lussen
- Hittebestendig binnenwerk
- Vernikkelde contacten
- Beschermingsklasse IP67

QUICK CONNECT



11455

Ampere	Polen	110V 50-60 Hz			230V 50-60 Hz			400V 50-60 Hz			500V 50-60 Hz			>50V 301-500Hz			>50V 100-300Hz			kg Gewicht
		3pol	4pol	5pol	3pol	4pol	5pol	3pol	4pol	5pol	3pol	4pol	5pol	3pol	4pol	5pol	3pol	4pol	5pol	
16	3	11452															0.430			
16	4				11790			11453			110020						0.450			
16	5	11455															0.470			

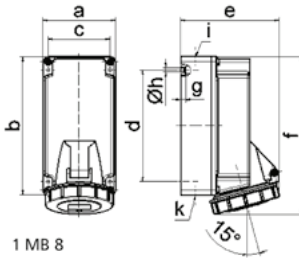

1 MB 8

Ampere	16	16	16
Polzahl	3	4	5
a	90,0	90,0	90,0
b	170,0	170,0	170,0
c	77,0	77,0	77,0
d	137,5	137,5	137,5
e	108,0	115,0	122,0
f	191,5	191,5	195,0
g	6,5	6,5	6,5
h ø	5,5	5,5	5,5
i	M20	M20	M20
k	M20/25	M20/25	M20/25
Leiter mm² min	1,5	1,5	1,5
Leiter mm² max	4	4	4

CEE-wandcontactdoos TE

- Schroefloze klemmen
- KONTEX contact
- Om door te lussen
- Hittebestendig binnenwerk
- Vernikkelde contacten
- Beschermingsklasse IP67

QUICK CONNECT



110017

Ampere	Polen	110V 50-60 Hz			230V 50-60 Hz			400V 50-60 Hz			500V 50-60 Hz			>50V 301-500Hz			>50V 100-300Hz			kg Gewicht
		3pol	4pol	5pol	3pol	4pol	5pol	3pol	4pol	5pol	3pol	4pol	5pol	3pol	4pol	5pol				
32	3	110014															0.355			
32	4				110015			110016									0.800			
32	5	110017															0.814			

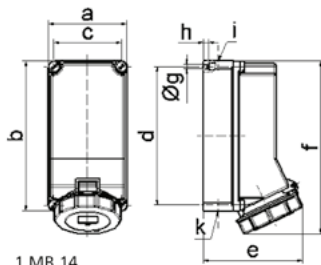

1 MB 14

Ampere	32	32	32
Polzahl	3	4	5
a	118,0	118,0	118,0
b	225,0	225,0	225,0
c	101,0	101,0	101,0
d	208,0	208,0	208,0
e	143,0	143,0	149,0
f	255,0	255,0	255,0
g ø	6,5	6,5	6,5
h	8,0	8,0	8,0
i	2xM25	2xM25	2xM25
k	2xM25	2xM25	2xM25
Leiter mm² min	2,5	2,5	2,5
Leiter mm² max	10	10	10

CEE-wandcontactdoos TE

- Schroefklemmen
- Hittebestendig binnenwerk
- KONTEX contact en raamklemmen
- Vernikkelde contacten
- Beschermingsklasse IP67
- Bij wandcontactdozen met Pilot graag een -P toevoegen aan het artikelnummer

11825



Ampere	Polen	110V 50-60 Hz			230V 50-60 Hz			400V 50-60 Hz			500V 50-60 Hz			>50V 301-500Hz			>50V 100-300Hz			kg Gewicht
		3pol	4pol	5pol	3pol	4pol	5pol	3pol	4pol	5pol	3pol	4pol	5pol	3pol	4pol	5pol				
63	3	11822															0.900			
63	4				11823			11824									0.920			
63	5	11825															0.949			

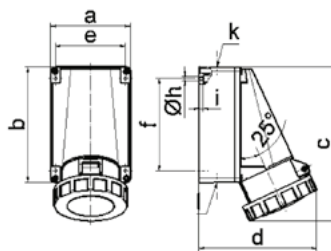

1 MB 3

Ampere	63	63	63
Polzahl	3	4	5
a	118,0	118,0	118,0
b	170,0	170,0	170,0
c	228,0	228,0	228,0
d	176,0	176,0	176,0
e	104,0	104,0	104,0
f	136,0	136,0	136,0
h ø	6,1	6,1	6,1
i	6,0	6,0	6,0
k	M40	M40	M40
l	M32/32	M32/32	M32/32
Leiter mm² min	6	6	6
Leiter mm² max	25	25	25

CEE-wandcontactdoos TE

- Schroefklemmen
- Om door te lussen
- Hittebestendig binnenwerk
- KONTEX contact en raamklemmen
- Vernikkelde contacten
- Beschermingsklasse IP67
- Bij wandcontactdozen met Pilot graag een -P toevoegen aan het artikelnummer



11829

	2P+E Ampere	3P+E Polen	110V 50-60 Hz	230V 50-60 Hz	400V 50-60 Hz	500V 50-60 Hz	>50V 301-500Hz	>50V 100-300Hz	kg
63	3		3pol 4pol 5pol 4h 4h 4h	3pol 4pol 5pol 6h 9h 9h	3pol 4pol 5pol 9h 6h 6h	3pol 4pol 5pol 7h 7h 7h	3pol 4pol 5pol 2h 2h 2h	3pol 4pol 5pol 10h 10h 10h	1.650
63	4								1.620
63	5								1.740

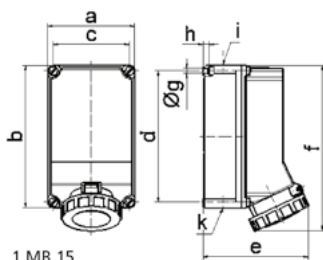

Ampere	63	63						
Polzahl	3/4	5						
a	160,0	160,0						
b	260,0	260,0						
c	140,0	140,0						
d	240,0	240,0						
e	195,0	195,0						
f	304,0	304,0						
g ø	8,1	8,1						
h	10,0	10,0						
i	M40	M40						
k	M32/40	M32/40						
Leiter mm² min	6	6						
Leiter mm² max	25	25						

CEE-wandcontactdoos TE

- Schroefklemmen
- Hittebestendig binnenwerk
- KONTEX contact en raamklemmen
- Vernikkelde contacten
- Beschermingsklasse IP67
- Bij wandcontactdozen met Pilot graag een -P toevoegen aan het artikelnummer



11815

	2P+E Ampere	3P+E Polen	110V 50-60 Hz	230V 50-60 Hz	400V 50-60 Hz	500V 50-60 Hz	>50V 301-500Hz	>50V 100-300Hz	kg
125	3		3pol 4pol 5pol 4h 4h 4h	3pol 4pol 5pol 6h 9h 9h	3pol 4pol 5pol 9h 6h 6h	3pol 4pol 5pol 7h 7h 7h	3pol 4pol 5pol 2h 2h 2h	3pol 4pol 5pol 10h 10h 10h	3.005
125	4								3.370
125	5								3.370

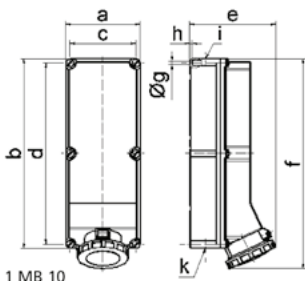

Ampere	125	125	125					
Polzahl	3	4	5					
a	180,0	180,0	180,0					
b	460,0	460,0	460,0					
c	160,0	160,0	160,0					
d	440,0	440,0	440,0					
e	208,0	208,0	208,0					
f	510,0	510,0	510,0					
g ø	8,3	8,3	8,3					
h	6,5	6,5	6,5					
i	M40	M40	M40					
k	M40/50	M40/50	M40/50					
Leiter mm² min	25	25	25					
Leiter mm² max	70	70	70					

CEE-wandcontactdoos

- Met elektrische PSK-vergrendeling en M20 wartel boven
- Hittebestendige contactdragers
- KONTEX contact
- Raamklemmen
- Beschermingsklasse IP44

		110V 50-60 Hz	230V 50-60 Hz	400V 50-60 Hz	500V 50-60 Hz	>50V 301-500Hz	>50V 100-300Hz	kg
		3pol 4pol 5pol 4h 4h 4h	3pol 4pol 5pol 6h 9h 9h	3pol 4pol 5pol 9h 6h 6h	3pol 4pol 5pol 7h 7h 7h	3pol 4pol 5pol 2h 2h 2h	3pol 4pol 5pol 10h 10h 10h	Gewicht
63	4			11785	11786			0.860
63	5			11787				0.900



11787

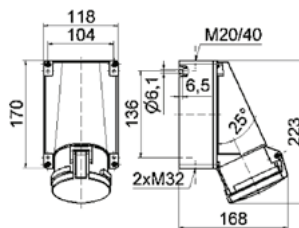

1 MB 36

CEE-wandcontactdoos

- Met elektrische PSK-vergrendeling en extra M20 boven
- Hittebestendig binnenwerk
- Vernikkelde contacten
- KONTEX contact
- Raamklemmen
- Beschermingsklasse IP67

		110V 50-60 Hz	230V 50-60 Hz	400V 50-60 Hz	500V 50-60 Hz	>50V 301-500Hz	>50V 100-300Hz	kg
		3pol 4pol 5pol 4h 4h 4h	3pol 4pol 5pol 6h 9h 9h	3pol 4pol 5pol 9h 6h 6h	3pol 4pol 5pol 7h 7h 7h	3pol 4pol 5pol 2h 2h 2h	3pol 4pol 5pol 10h 10h 10h	Gewicht
63	4			11052	11014			
63	5			11038				0.960



11038

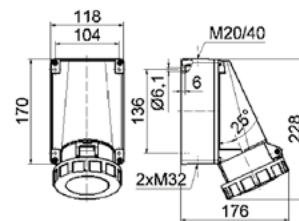

1 MB 31

CEE-wandcontactdoos

- Met elektrische PSK-vergrendeling, magneetschakelaar en extra M20 boven
- Hittebestendig binnenwerk
- Vernikkelde contacten
- KONTEX contact
- Raamklemmen
- Beschermingsklasse IP67

		110V 50-60 Hz	230V 50-60 Hz	400V 50-60 Hz	500V 50-60 Hz	>50V 301-500Hz	>50V 100-300Hz	kg
		3pol 4pol 5pol 4h 4h 4h	3pol 4pol 5pol 6h 9h 9h	3pol 4pol 5pol 9h 6h 6h	3pol 4pol 5pol 7h 7h 7h	3pol 4pol 5pol 2h 2h 2h	3pol 4pol 5pol 10h 10h 10h	Gewicht
63	4			16070	16071			2.800
63	5			16072				2.915



16072

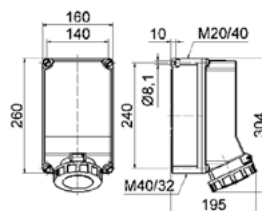

1 MB 32

CEE-wandcontactdozen met pilotcontact

Technische informatie - NEN-EN-IEC 60309-1/2, VDE 0623
 - Met elektrische PSK vergrendeling.

CEE-wandcontactdoos

- Met elektrische PSK-vergrendeling en schakelaar
- Hittebestendig binnenwerk
- Vernikkelde contacten
- KONTEX contact
- Raamklemmen
- Beschermingsklasse IP67



110V
50-60 Hz

230V
50-60 Hz

400V
50-60 Hz

500V
50-60 Hz

>50V
301-500Hz

>50V
100-300Hz

kg
Gewicht

125	4		1674	1675	9.100
125	5		1676		9.115



1676

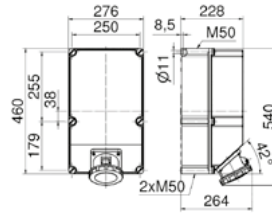

30 MB 104

CEE-wandcontactdoos

- Met montagerail
- 8 module
- KONTEX contact
- Vernikkelde contacten
- Raamklemmen
- Beschermingsklasse IP44
- Bij 63A wandcontactdozen met Pilot graag een -P toevoegen aan het artikelnummer

		110V 50-60 Hz	230V 50-60 Hz	400V 50-60 Hz	500V 50-60 Hz	>50V 301-500Hz	>50V 100-300Hz	kg
		3pol 4pol 5pol 4h 4h 4h	3pol 4pol 5pol 6h 9h 9h	3pol 4pol 5pol 9h 6h 6h	3pol 4pol 5pol 7h 7h 7h	3pol 4pol 5pol 2h 2h 2h	3pol 4pol 5pol 10h 10h 10h	Gewicht
63	5	15038						2.830



15038

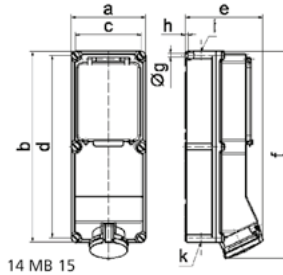

Ampere Polzahl	63 4	63 5
a	180,0	180,0
b	460,0	460,0
c	160,0	160,0
d	440,0	440,0
e	182,0	182,0
f	498,0	498,0
g ø	8,3	8,3
h	6,5	6,5
i	M40	M40
k	M32/40	M32/40

CEE-wandcontactdoos

- Met montagerail
- 5 module
- Vernikkelde contacten
- Beschermingsklasse IP44

		110V 50-60 Hz	230V 50-60 Hz	400V 50-60 Hz	500V 50-60 Hz	>50V 301-500Hz	>50V 100-300Hz	kg
		3pol 4pol 5pol 4h 4h 4h	3pol 4pol 5pol 6h 9h 9h	3pol 4pol 5pol 9h 6h 6h	3pol 4pol 5pol 7h 7h 7h	3pol 4pol 5pol 2h 2h 2h	3pol 4pol 5pol 10h 10h 10h	Gewicht
16	3	15019						0.495
16	4	15095						156
16	5	15096						15059



15059

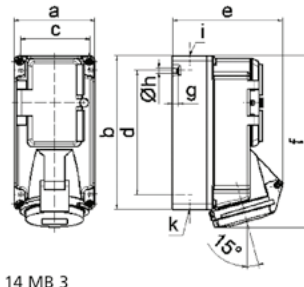

Ampere Polzahl	16 3	16 4	16 5
a	90,0	90,0	90,0
b	170,0	170,0	170,0
c	77,0	77,0	77,0
d	137,5	137,5	137,5
e	118,0	114,0	121,0
f	188,5	188,5	190,0
g	6,0	6,0	6,0
h ø	5,5	5,5	5,5
i	M20	M20	M20
k	M20/25	M20/25	M20/25

CEE-wandcontactdoos

- Met montagerail
- 5 module
- Vernikkelde contacten
- Beschermingsklasse IP44

		110V 50-60 Hz	230V 50-60 Hz	400V 50-60 Hz	500V 50-60 Hz	>50V 301-500Hz	>50V 100-300Hz	kg
		3pol 4pol 5pol 4h 4h 4h	3pol 4pol 5pol 6h 9h 9h	3pol 4pol 5pol 9h 6h 6h	3pol 4pol 5pol 7h 7h 7h	3pol 4pol 5pol 2h 2h 2h	3pol 4pol 5pol 10h 10h 10h	Gewicht
16	4	1582						0.800
16	5	1583						0.840
32	3	15030						0.830
32	4	1584						0.850
32	5	1585						0.870



1585

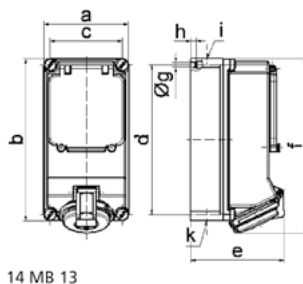

Ampere Polzahl	16 4	16 5	32 3	32 4	32 5
a	118,0	118,0	118,0	118,0	118,0
b	225,0	225,0	225,0	225,0	225,0
c	101,0	101,0	101,0	101,0	101,0
d	208,0	208,0	208,0	208,0	208,0
e	123,0	130,0	134,0	134,0	141,0
f	242,0	242,0	250,0	250,0	250,0
g	6,5	6,5	6,5	6,5	6,5
h ø	8,0	8,0	8,0	8,0	8,0
i	2 x M25	2 x M25	2 x M25	2 x M25	2 x M25
k	2 x M25	2 x M25	2 x M25	2 x M25	2 x M25

CEE-wandcontactdozen beveiligd IP44

Technische informatie - NEN-EN-IEC 60309-1/2, VDE 0623

- Behuizing, klapvenster en contactdoos van hoogwaardig kunststof

CEE-wandcontactdoos

- Met montagerail
- 7 module
- 63A met raamklemmen en KONTEX contact
- Vernikkelde contacten
- Beschermingsklasse IP44
- Bij 63A wandcontactdozen met Pilot graag een -P toevoegen aan het artikelnummer

	3PHE Ampere	3PHE Polen	110V 50-60 Hz	230V 50-60 Hz	400V 50-60 Hz	500V 50-60 Hz	>50V 301-500Hz	>50V 100-300Hz	kg
	3pol 4h	4pol 4h	5pol 4h	3pol 6h 4pol 9h 5pol 9h	3pol 9h 4pol 6h 5pol 6h	3pol 7h 4pol 7h 5pol 7h	3pol 2h 4pol 2h 5pol 2h	3pol 10h 4pol 10h 5pol 10h	Gewicht
32	4				15129				0.216
32	5				15130				1.555
63	5				15036				1.895



15036

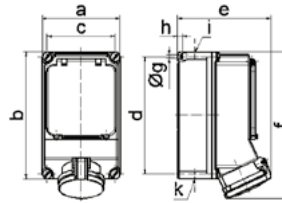

14 MB 14

CEE-wandcontactdoos

- Met montagerail
- 5 module
- Vernikkelde contacten
- Beschermingsklasse IP67

Ampere	Polen	110V 50-60 Hz			230V 50-60 Hz			400V 50-60 Hz			500V 50-60 Hz			>50V 301-500Hz			>50V 100-300Hz			kg Gewicht
		3pol	4pol	5pol	3pol	4pol	5pol	3pol	4pol	5pol	3pol	4pol	5pol	3pol	4pol	5pol	3pol	4pol	5pol	
16	3	15024															0.513			
16	4	15097															0.550			
16	5	15100															0.580			



15100

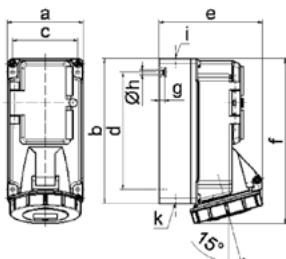

14 MB 6

Ampere Polzahl	16 3	16 4	16 5
a	90,0	90,0	90,0
b	170,0	170,0	170,0
c	77,0	77,0	77,0
d	137,5	137,5	137,5
e	108,0	115,0	121,0
f	191,5	191,5	191,5
g	6,0	6,0	6,0
h ø	5,5	5,5	5,5
i	M20	M20	M20
k	M20/25	M20/25	M20/25

CEE-wandcontactdoos

- Met montagerail
- 5 module
- Vernikkelde contacten
- Beschermingsklasse IP67

Ampere	Polen	110V 50-60 Hz			230V 50-60 Hz			400V 50-60 Hz			500V 50-60 Hz			>50V 301-500Hz			>50V 100-300Hz			kg Gewicht
		3pol	4pol	5pol	3pol	4pol	5pol	3pol	4pol	5pol	3pol	4pol	5pol	3pol	4pol	5pol				
16	5	15028															0.875			
32	3	15352															0.924			
32	4	15111 15177															0.939			
32	5	15112															0.960			



15112

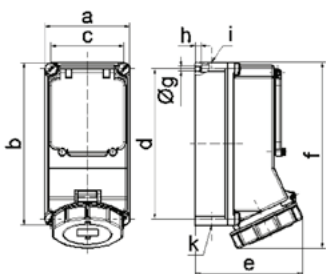

14 MB 12

Ampere Polzahl	16 4	16 5	32 3	32 4	32 5
a	118,0	118,0	118,0	118,0	118,0
b	225,0	225,0	225,0	225,0	225,0
c	101,0	101,0	101,0	101,0	101,0
d	208,0	208,0	208,0	208,0	208,0
e	127,0	134,0	143,0	143,0	149,0
f	245,0	245,0	255,0	255,0	255,0
g ø	6,5	6,5	6,5	6,5	6,5
h	8,0	8,0	8,0	8,0	8,0
i	2 x M25	2 x M25	2 x M25	2 x M25	2 x M25
k	2 x M25	2 x M25	2 x M25	2 x M25	2 x M25

CEE-wandcontactdoos

- Met montagerail
- 7 module
- 63A met raakklems en KONTEX contact
- Vernikkelde contacten
- Beschermingsklasse IP67
- Bij 63A wandcontactdozen met Pilot graag een -P toevoegen aan het artikelnummer

Ampere	Polen	110V 50-60 Hz			230V 50-60 Hz			400V 50-60 Hz			500V 50-60 Hz			>50V 301-500Hz			>50V 100-300Hz			kg Gewicht
		3pol	4pol	5pol	3pol	4pol	5pol	3pol	4pol	5pol	3pol	4pol	5pol	3pol	4pol	5pol				
63	4	15000															1.990			
63	5	15001															2.060			



15001

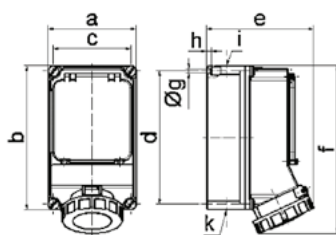

14 MB 11

Ampere Polzahl	32 4	32 5	63 4	63 5
a	160,0	160,0	160,0	160,0
b	260,0	260,0	260,0	260,0
c	140,0	140,0	140,0	140,0
d	240,0	240,0	240,0	240,0
e	172,0	174,0	195,0	195,0
f	293,0	294,0	304,0	304,0
g ø	8,1	8,1	8,1	8,1
h	10,0	10,0	10,0	10,0
i	M40	M40	M40	M40
k	M32/40	M32/40	M32/40	M32/40

CEE-wandcontactdoos

- Met montagerail
- 8 module
- KONTEX contact
- Raamklemmen
- Vernikkelde contacten
- Beschermingsklasse IP67
- Bij 63A en 125A wandcontactdozen met Pilot graag een -P toevoegen aan het artikelnummer



15047

		110V 50-60 Hz	230V 50-60 Hz	400V 50-60 Hz	500V 50-60 Hz	>50V 301-500Hz	>50V 100-300Hz	kg
		3pol 4pol 5pol 4h 4h 4h	3pol 4pol 5pol 6h 9h 9h	3pol 4pol 5pol 9h 6h 6h	3pol 4pol 5pol 7h 7h 7h	3pol 4pol 5pol 2h 2h 2h	3pol 4pol 5pol 10h 10h 10h	Gewicht
63	4	1580						2.890
63	5	15047						2.890
125	4	15158						3.795
125	5	15160						3.795

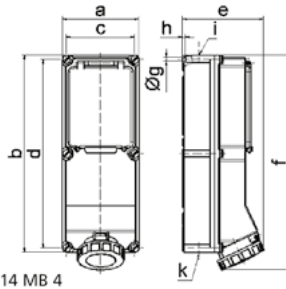

Ampere Polzahl	63 3	63 4	63 5	125 4	125 5
a	180,0	180,0	180,0	180,0	180,0
b	460,0	460,0	460,0	460,0	460,0
c	160,0	160,0	160,0	160,0	160,0
d	440,0	440,0	440,0	440,0	440,0
e	191,0	191,0	191,0	210,0	210,0
f	500,0	500,0	500,0	512,0	512,0
g ø	8,3	8,3	8,3	8,3	8,3
h	6,5	6,5	6,5	6,5	6,5
i	M40	M40	M40	M40	M40
k	M32/40	M32/40	M32/40	M40/50	M40/50

CEE-wandcontactdoos

- Afschakelbaar
- In 0-stand hangslot vergrendeling mogelijk
- Mechanische dubbele vergrendeling
- Vernikkelde contacten
- Beschermingsklasse IP44

Ampere	Polen	110V 50-60 Hz			230V 50-60 Hz			400V 50-60 Hz			500V 50-60 Hz			>50V 301-500Hz			>50V 100-300Hz			kg Gewicht
		3pol	4pol	5pol	3pol	4pol	5pol	3pol	4pol	5pol	3pol	4pol	5pol	3pol	4pol	5pol	3pol	4pol	5pol	
16	3																1619	0.575		
16	4																1641	1610	1616	0.590
16	5																1642	1611		0.615



1611

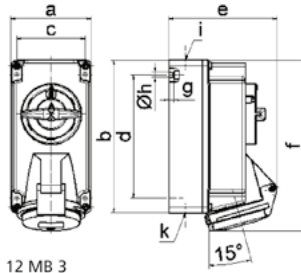

12 MB 3

Ampere	16	16	16			
Polzahl	3	4	5			
a	90,0	90,0	90,0			
b	170,0	170,0	170,0			
c	77,0	77,0	77,0			
d	137,5	137,5	137,5			
e	108,0	114,0	121,0			
f	188,5	188,5	190,0			
g	6,0	6,0	6,0			
h ø	5,5	5,5	5,5			
i	M20	M20	M20			
k	M20/25	M20/25	M20/25			

CEE-wandcontactdoos

- Afschakelbaar
- In 0-stand hangslot vergrendeling mogelijk
- Mechanische dubbele vergrendeling
- Vernikkelde contacten
- Beschermingsklasse IP44

Ampere	Polen	110V 50-60 Hz			230V 50-60 Hz			400V 50-60 Hz			500V 50-60 Hz			>50V 301-500Hz			>50V 100-300Hz			kg Gewicht
		3pol	4pol	5pol	3pol	4pol	5pol	3pol	4pol	5pol	3pol	4pol	5pol	3pol	4pol	5pol				
16	4																16058	16038	16064	0.960
16	5																16039			0.985
32	3																16097			1.170
32	4																16060	16042	16066	1.185
32	5																16043			1.240



16039

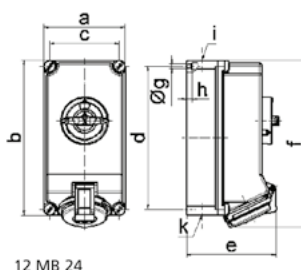

12 MB 24

Ampere	16	16	32	32	32			
Polzahl	4	5	3	4	5			
a	118,0	118,0	118,0	118,0	118,0			
b	225,0	225,0	225,0	225,0	225,0			
c	101,0	101,0	101,0	101,0	101,0			
d	208,0	208,0	208,0	208,0	208,0			
e	126,0	134,0	137,0	137,0	144,0			
f	242,0	242,0	251,0	251,0	251,0			
g ø	6,5	6,5	6,5	6,5	6,5			
h	8,0	8,0	8,0	8,0	8,0			
i	2 x M25	2 x M25	2 x M25	2 x M25	2 x M25			
k	2 x M25	2 x M25	2 x M25	2 x M25	2 x M25			

CEE-wandcontactdoos

- Afschakelbaar
- In 0-stand hangslot vergrendeling mogelijk
- Mechanische dubbele vergrendeling
- Vernikkelde contacten
- Beschermingsklasse IP44
- Bij 63A wandcontactdozen met Pilot graag een -P toevoegen aan het artikelnummer
- Als afschakelbaar op aanvraag

Ampere	Polen	110V 50-60 Hz			230V 50-60 Hz			400V 50-60 Hz			500V 50-60 Hz			>50V 301-500Hz			>50V 100-300Hz			kg Gewicht
		3pol	4pol	5pol	3pol	4pol	5pol	3pol	4pol	5pol	3pol	4pol	5pol	3pol	4pol	5pol				
63	3																16956	2.055		
63	4																16933	16605	16827	2.105
63	5																16603			2.245



16603

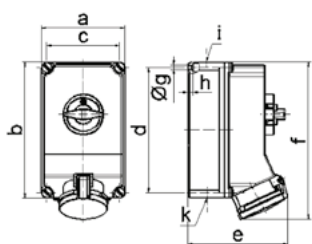

12 MB 30

Ampere	63	63	63			
Polzahl	3	4	5			
a	160,0	160,0	160,0			
b	260,0	260,0	260,0			
c	140,0	140,0	140,0			
d	240,0	240,0	240,0			
e	184,0	184,0	184,0			
f	302,0	302,0	302,0			
g ø	8,1	8,1	8,1			
h	10,0	10,0	10,0			
i	M40	M40	M40			
k	M32/40	M32/40	M32/40			

CEE-wandcontactdoos

- Afschakelbaar
- In 0-stand hangslot vergrendeling mogelijk
- Mechanische dubbele vergrendeling
- Vernikkelde contacten
- Beschermingsklasse IP67

	110V 50-60 Hz	230V 50-60 Hz	400V 50-60 Hz	500V 50-60 Hz	>50V 301-500Hz	>50V 100-300Hz	kg
	3pol 4pol 5pol 4h 4h 4h	3pol 4pol 5pol 6h 9h 9h	3pol 4pol 5pol 9h 6h 6h	3pol 4pol 5pol 7h 7h 7h	3pol 4pol 5pol 2h 2h 2h	3pol 4pol 5pol 10h 10h 10h	Gewicht
3							0.623
16 3		160048	160056				0.595
16 4		160053	160049	160057			0.610
16 5		160055	160052				0.685



160052

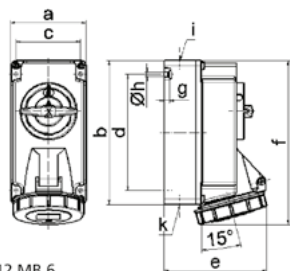

12 MB 6

Ampere Polzahl	16 3	16 4	16 5
a	90,0	90,0	90,0
b	170,0	170,0	170,0
c	77,0	77,0	77,0
d	137,5	137,5	137,5
e	108,0	115,0	121,0
f	191,5	191,5	191,5
g	6,0	6,0	6,0
h ø	5,5	5,5	5,5
i	M20	M20	M20
k	M20/25	M20/25	M20/25

CEE-wandcontactdoos

- Afschakelbaar
- In 0-stand hangslot vergrendeling mogelijk
- Mechanische dubbele vergrendeling
- Beschermingsklasse IP67

	110V 50-60 Hz	230V 50-60 Hz	400V 50-60 Hz	500V 50-60 Hz	>50V 301-500Hz	>50V 100-300Hz	kg
	3pol 4pol 5pol 4h 4h 4h	3pol 4pol 5pol 6h 9h 9h	3pol 4pol 5pol 9h 6h 6h	3pol 4pol 5pol 7h 7h 7h	3pol 4pol 5pol 2h 2h 2h	3pol 4pol 5pol 10h 10h 10h	Gewicht
4							1.240
16 4		16059	16040	16065			0.995
16 5			16041				1.030
32 3	16124	16104					1.230
32 4			160178	160179			1.240
32 5			160177				1.300



16041

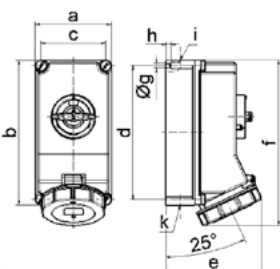

12 MB 11

Ampere Polzahl	16 4	16 5	32 3	32 4	32 5
a	118,0	118,0	118,0	118,0	118,0
b	225,0	225,0	225,0	225,0	225,0
c	101,0	101,0	101,0	101,0	101,0
d	208,0	208,0	208,0	208,0	208,0
e	127,0	134,0	143,0	143,0	149,0
f	245,0	245,0	255,0	255,0	255,0
g ø	6,5	6,5	6,5	6,5	6,5
h	8,0	8,0	8,0	8,0	8,0
i	2 x M25	2 x M25	2 x M25	2 x M25	2 x M25
k	2 x M25	2 x M25	2 x M25	2 x M25	2 x M25

CEE-wandcontactdoos

- Afschakelbaar
- In 0-stand hangslot vergrendeling mogelijk
- Mechanische dubbele vergrendeling
- KONTEX contact
- Vernikkelde contacten
- Raamklemmen
- Beschermingsklasse IP67
- Bij 63A wandcontactdozen met Pilot graag een -P toevoegen aan het artikelnummer

	110V 50-60 Hz	230V 50-60 Hz	400V 50-60 Hz	500V 50-60 Hz	>50V 301-500Hz	>50V 100-300Hz	kg
	3pol 4pol 5pol 4h 4h 4h	3pol 4pol 5pol 6h 9h 9h	3pol 4pol 5pol 9h 6h 6h	3pol 4pol 5pol 7h 7h 7h	3pol 4pol 5pol 2h 2h 2h	3pol 4pol 5pol 10h 10h 10h	Gewicht
63 3		16606					2.135
63 4		16934	16604	16828			2.240
63 5			16602				2.300



16602

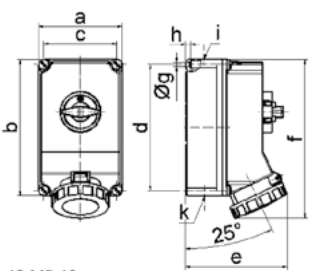

12 MB 10

Ampere Polzahl	63 3	63 4	63 5
a	160,0	160,0	160,0
b	260,0	260,0	260,0
c	140,0	140,0	140,0
d	240,0	240,0	240,0
e	195,0	195,0	195,0
f	304,0	304,0	304,0
g ø	8,1	8,1	8,1
h	10,0	10,0	10,0
i	M40	M40	M40
k	M32/40	M32/40	M32/40

CEE-wandcontactdozen afschakelbaar vergrendelbaar IP67

Technische informatie - NEN-EN-IEC 60309-1/2, VDE 0623

- Behuizing, klapvenster en contactdoos van hoogwaardig kunststof

CEE-wandcontactdoos

- Afschakelbaar
- Mechanische dubbele vergrendeling
- KONTEX contact
- Vernikkelde contacten
- Raamklemmen
- Beschermingsklasse IP67
- Bij 125A wandcontactdozen met Pilot graag een -P toevoegen aan het artikelnummer

Ampere	Polen	110V 50-60 Hz		230V 50-60 Hz		400V 50-60 Hz		500V 50-60 Hz		>50V 301-500Hz		>50V 100-300Hz		kg Gewicht			
		3pol 4h	4pol 4h	5pol 4h	3pol 6h	4pol 9h	5pol 9h	3pol 9h	4pol 6h	5pol 6h	3pol 7h	4pol 7h	5pol 7h		3pol 2h	4pol 2h	5pol 2h
125	3	16620										3.500					
125	4	16930		16621		16831								3.725			
125	5	16622										3.890					



16622

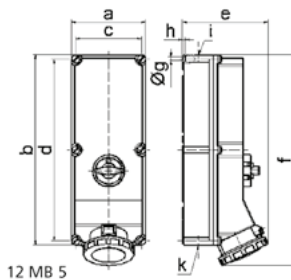

Ampere	125	125	125			
Polzahl	3	4	5			
a	180,0	180,0	180,0			
b	460,0	460,0	460,0			
c	160,0	160,0	160,0			
d	440,0	440,0	440,0			
e	208,0	208,0	208,0			
f	510,0	510,0	510,0			
g ø	8,3	8,3	8,3			
h	6,5	6,5	6,5			
i	M40	M40	M40			
k	M40/50	M40/50	M40/50			

CEE-wandcontactdoos

- Afschakelbaar
- In 0-stand hangslot vergrendeling mogelijk
- Met montagerail
- 6 module
- Vernikkelde contacten
- Beschermingsklasse IP44



110V 50-60 Hz	230V 50-60 Hz	400V 50-60 Hz	500V 50-60 Hz	>50V 301-500Hz	>50V 100-300Hz
3pol 4pol 5pol 4h 4h 4h	3pol 4pol 5pol 6h 9h 9h	3pol 4pol 5pol 9h 6h 6h	3pol 4pol 5pol 7h 7h 7h	3pol 4pol 5pol 2h 2h 2h	3pol 4pol 5pol 10h 10h 10h

16	4	17275	17055	17337	1.590
16	5		17056		1.620
32	4		17057	17338	1.820
32	5		17058		1.880

Ampere	16	16	32	32	63	63
Polzahl	4	5	4	5	4	5
a	134,0	134,0	134,0	134,0	180,0	180,0
b	365,0	365,0	365,0	365,0	460,0	460,0
c	117,0	117,0	117,0	117,0	160,0	160,0
d	348,0	348,0	348,0	348,0	440,0	440,0
e	135,0	141,0	146,0	152,0	184,0	184,0
f	382,0	382,0	391,0	391,0	500,0	500,0
g ø	6,5	6,5	6,5	6,5	8,3	8,3
h	8,0	8,0	8,0	8,0	6,5	6,5
i	M25/32	M25/32	M32/40	M32/40	M40	M40
k	M25/32	M25/32	M32/40	M32/40	M32/40	M32/40
l	156,0	156,0	156,0	156,0	189,0	189,0

16	4	17277	17059	17339	3.245
16	5		17060		3.245

17060

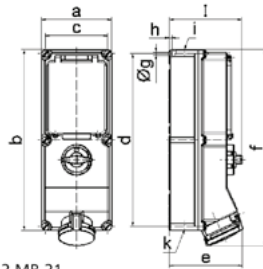

12 MB 21

CEE-wandcontactdoos

- Afschakelbaar
- In 0-stand hangslot vergrendeling mogelijk
- Met montagerail
- 8 module
- 63A met raamklemmen en KONTEX contact
- Vernikkelde contacten
- Beschermingsklasse IP44
- Bij 63A wandcontactdozen met Pilot graag een -P toevoegen aan het artikelnummer



110V 50-60 Hz	230V 50-60 Hz	400V 50-60 Hz	500V 50-60 Hz	>50V 301-500Hz	>50V 100-300Hz
3pol 4pol 5pol 4h 4h 4h	3pol 4pol 5pol 6h 9h 9h	3pol 4pol 5pol 9h 6h 6h	3pol 4pol 5pol 7h 7h 7h	3pol 4pol 5pol 2h 2h 2h	3pol 4pol 5pol 10h 10h 10h

63	4	17277	17059	17339	3.245
63	5		17060		3.245

Ampere	16	16	32	32	63	63
Polzahl	4	5	4	5	4	5
a	134,0	134,0	134,0	134,0	180,0	180,0
b	365,0	365,0	365,0	365,0	460,0	460,0
c	117,0	117,0	117,0	117,0	160,0	160,0
d	348,0	348,0	348,0	348,0	440,0	440,0
e	135,0	141,0	146,0	152,0	184,0	184,0
f	382,0	382,0	391,0	391,0	500,0	500,0
g ø	6,5	6,5	6,5	6,5	8,3	8,3
h	8,0	8,0	8,0	8,0	6,5	6,5
i	M25/32	M25/32	M32/40	M32/40	M40	M40
k	M25/32	M25/32	M32/40	M32/40	M32/40	M32/40
l	156,0	156,0	156,0	156,0	189,0	189,0

63	4	17165	17164	17166	1.665
63	5		17163		1.685
32	4		17168	17169	1.855
32	5		17170		2.020

17060

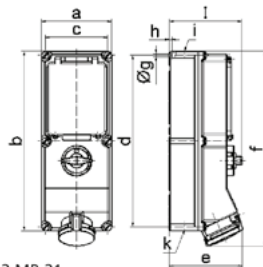

12 MB 21

CEE-wandcontactdoos

- Afschakel-/vergrendelbaar
- In 0-stand hangslot vergrendeling mogelijk
- Met montagerail
- 6 module
- Vernikkelde contacten
- Beschermingsklasse IP44



110V 50-60 Hz	230V 50-60 Hz	400V 50-60 Hz	500V 50-60 Hz	>50V 301-500Hz	>50V 100-300Hz
3pol 4pol 5pol 4h 4h 4h	3pol 4pol 5pol 6h 9h 9h	3pol 4pol 5pol 9h 6h 6h	3pol 4pol 5pol 7h 7h 7h	3pol 4pol 5pol 2h 2h 2h	3pol 4pol 5pol 10h 10h 10h

16	4	17165	17164	17166	1.665
16	5		17163		1.685
32	4		17168	17169	1.855
32	5		17170		2.020

Ampere	16	16	32	32	63	63
Polzahl	4	5	4	5	4	5
a	134,0	134,0	134,0	134,0	180,0	180,0
b	365,0	365,0	365,0	365,0	460,0	460,0
c	117,0	117,0	117,0	117,0	160,0	160,0
d	348,0	348,0	348,0	348,0	440,0	440,0
e	135,0	141,0	146,0	152,0	184,0	184,0
f	382,0	382,0	391,0	391,0	500,0	500,0
g ø	6,5	6,5	6,5	6,5	8,3	8,3
h	8,0	8,0	8,0	8,0	6,5	6,5
i	M25/32	M25/32	M32/40	M32/40	M40	M40
k	M25/32	M25/32	M32/40	M32/40	M32/40	M32/40
l	156,0	156,0	156,0	156,0	189,0	189,0

16	4	17165	17164	17166	1.665
16	5		17163		1.685
32	4		17168	17169	1.855
32	5		17170		2.020

17524

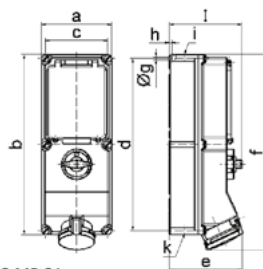

12 MB 21

CEE-wandcontactdoos

- Afschakel-/vergrendelbaar
- In 0-stand hangslot vergrendeling mogelijk
- Met montagerail
- 8 module
- Vernikkelde contacten
- Beschermingsklasse IP44
- Bij 63A wandcontactdozen met Pilot graag een -P toevoegen aan het artikelnummer

		110V 50-60 Hz	230V 50-60 Hz	400V 50-60 Hz	500V 50-60 Hz	>50V 301-500Hz	>50V 100-300Hz	kg
		3pol 4pol 5pol 4h 4h 4h	3pol 4pol 5pol 6h 9h 9h	3pol 4pol 5pol 9h 6h 6h	3pol 4pol 5pol 7h 7h 7h	3pol 4pol 5pol 2h 2h 2h	3pol 4pol 5pol 10h 10h 10h	Gewicht
63	4		17521	17522	17523			3.205
63	5			17524				3.450



17524

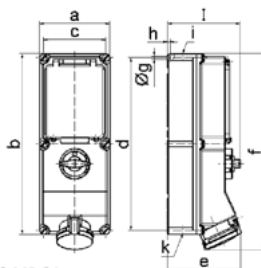

12 MB 21

Ampere	16	16	32	32	63	63
Polzahl	4	5	4	5	4	5
a	134,0	134,0	134,0	134,0	180,0	180,0
b	365,0	365,0	365,0	365,0	460,0	460,0
c	117,0	117,0	117,0	117,0	160,0	160,0
d	348,0	348,0	348,0	348,0	440,0	440,0
e	135,0	141,0	146,0	152,0	184,0	184,0
f	382,0	382,0	391,0	391,0	500,0	500,0
g	6,5	6,5	6,5	6,5	8,3	8,3
h	8,0	8,0	8,0	8,0	6,5	6,5
i	M25/32	M25/32	M32/40	M32/40	M40	M40
k	M25/32	M25/32	M32/40	M32/40	M32/40	M32/40
l	156,0	156,0	156,0	156,0	189,0	189,0

CEE-wandcontactdoos

- Afschakelbaar
- In 0-stand hangslot vergrendeling mogelijk
- Met montagerail
- 6 module
- Vernikkelde contacten
- Beschermingsklasse IP67



110V
50-60 Hz

230V
50-60 Hz

400V
50-60 Hz

500V
50-60 Hz

>50V
301-500Hz

>50V
100-300Hz

kg

Ampere	Poles	110V 50-60 Hz	230V 50-60 Hz	400V 50-60 Hz	500V 50-60 Hz	>50V 301-500Hz	>50V 100-300Hz	Gewicht
16	4		17278	17061	17340			
16	5			17062				1.675
32	4	17162	17063	17341				2.078
32	5		17064					1.950



17066

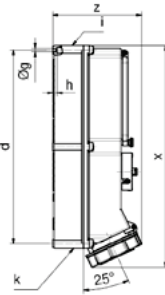
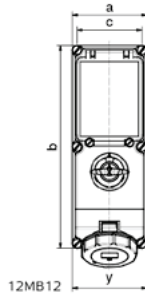

Ampere	Poles	16	16	32	32	63	63
a	4	134	134	134	134	180	180
b	4	365	365	365	365	460	460
c	4	117	117	117	117	160	160
d	4	348	348	348	348	440	440
Øg	4	6,5	6,5	6,5	6,5	8,3	8,3
h	4	8	8	8	8	6,5	6,5
i	4	M32/25	M32/25	M40/32	M40/32	M40	M40
k	4	M32/25	M32/25	M40/32	M40/32	M40/32	M40/32
x	4	390	390	400	400	503	503
y	4	134	134	134	134	180	180
z	4	153	153	154	161	192	192

CEE-wandcontactdoos

- Afschakel-/vergrendelbaar
- In 0-stand hangslot vergrendeling mogelijk
- Met montagerail
- 6 module
- Vernikkelde contacten
- Beschermingsklasse IP67



110V
50-60 Hz

230V
50-60 Hz

400V
50-60 Hz

500V
50-60 Hz

>50V
301-500Hz

>50V
100-300Hz

kg

Ampere	Poles	110V 50-60 Hz	230V 50-60 Hz	400V 50-60 Hz	500V 50-60 Hz	>50V 301-500Hz	>50V 100-300Hz	Gewicht
16	4		17175	17176	17177			1.685
16	5			17178				1.735
32	4	17180	17181					1.955
32	5		17182					2.010



17541

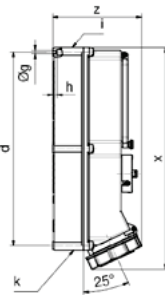
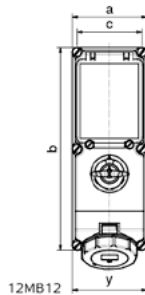

Ampere	Poles	16	16	32	32	63	63
a	4	134	134	134	134	180	180
b	4	365	365	365	365	460	460
c	4	117	117	117	117	160	160
d	4	348	348	348	348	440	440
Øg	4	6,5	6,5	6,5	6,5	8,3	8,3
h	4	8	8	8	8	6,5	6,5
i	4	M32/25	M32/25	M40/32	M40/32	M40	M40
k	4	M32/25	M32/25	M40/32	M40/32	M40/32	M40/32
x	4	390	390	400	400	503	503
y	4	134	134	134	134	180	180
z	4	153	153	154	161	192	192

CEE-wandcontactdoos

- Afschakel-/vergrendelbaar
- In 0-stand hangslot vergrendeling mogelijk
- Met montagerail
- 8 module
- Vernikkelde contacten
- Beschermingsklasse IP67
- Bij 63A wandcontactdozen met Pilot graag een -P toevoegen aan het artikelnummer



110V
50-60 Hz

230V
50-60 Hz

400V
50-60 Hz

500V
50-60 Hz

>50V
301-500Hz

>50V
100-300Hz

kg

Ampere	Poles	110V 50-60 Hz	230V 50-60 Hz	400V 50-60 Hz	500V 50-60 Hz	>50V 301-500Hz	>50V 100-300Hz	Gewicht
63	4		17539	17540				3.260
63	5		17541					3.415



17541

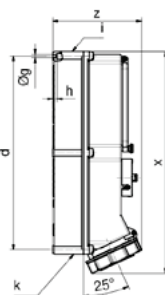
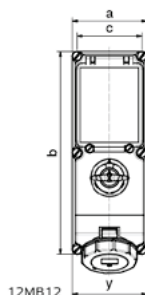

Ampere	Poles	16	16	32	32	63	63
a	4	134	134	134	134	180	180
b	4	365	365	365	365	460	460
c	4	117	117	117	117	160	160
d	4	348	348	348	348	440	440
Øg	4	6,5	6,5	6,5	6,5	8,3	8,3
h	4	8	8	8	8	6,5	6,5
i	4	M32/25	M32/25	M40/32	M40/32	M40	M40
k	4	M32/25	M32/25	M40/32	M40/32	M40/32	M40/32
x	4	390	390	400	400	503	503
y	4	134	134	134	134	180	180
z	4	153	153	154	161	192	192

CEE-wandcontactdoos

- Afschakelbaar
- Mechanische dubbele vergrendeling
- In 0-stand hangslot vergrendeling mogelijk
- Hittebestendige contactdragers
- Vernikkelde contacten
- Beschermingsklasse IP67

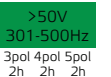
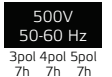
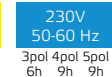
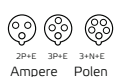

kg
Gewicht

16	5	160182					1.095
----	---	---------------	--	--	--	--	--------------



160182

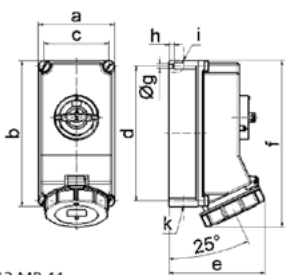

12 MB 11

Ampere Polzahl	16 4	16 5	32 3	32 4	32 5
a	118,0	118,0	118,0	118,0	118,0
b	225,0	225,0	225,0	225,0	225,0
c	101,0	101,0	101,0	101,0	101,0
d	208,0	208,0	208,0	208,0	208,0
e	127,0	134,0	143,0	143,0	149,0
f	245,0	245,0	255,0	255,0	255,0
g ø	6,5	6,5	6,5	6,5	6,5
h	8,0	8,0	8,0	8,0	8,0
i	2 x M25	2 x M25	2 x M25	2 x M25	2 x M25
k	2 x M25	2 x M25	2 x M25	2 x M25	2 x M25

CEE-wandcontactdoos

- Afschakelbaar
- Mechanische dubbele vergrendeling
- In 0-stand hangslot vergrendeling mogelijk
- Hittebestendige contactdragers
- Vernikkelde contacten
- Beschermingsklasse IP67

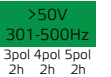
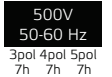
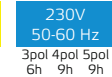
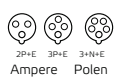

kg
Gewicht

32	5	160184					1.340
----	---	---------------	--	--	--	--	--------------



160184

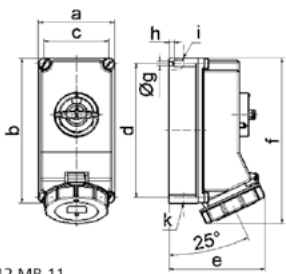

12 MB 11

Ampere Polzahl	16 4	16 5	32 3	32 4	32 5
a	118,0	118,0	118,0	118,0	118,0
b	225,0	225,0	225,0	225,0	225,0
c	101,0	101,0	101,0	101,0	101,0
d	208,0	208,0	208,0	208,0	208,0
e	127,0	134,0	143,0	143,0	149,0
f	245,0	245,0	255,0	255,0	255,0
g ø	6,5	6,5	6,5	6,5	6,5
h	8,0	8,0	8,0	8,0	8,0
i	2 x M25	2 x M25	2 x M25	2 x M25	2 x M25
k	2 x M25	2 x M25	2 x M25	2 x M25	2 x M25

CEE-wandcontactdoos

- Afschakelbaar
- Mechanische dubbele vergrendeling
- In 0-stand hangslot vergrendeling mogelijk
- Hittebestendige contactdragers
- Kontex contact en raamklemmen
- Vernikkelde contacten
- Beschermingsklasse IP67
- Bij 63A wandcontactdozen met Pilot graag een -P toevoegen aan het artikelnummer

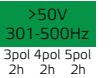
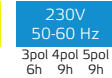
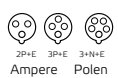

kg
Gewicht

63	5	16886					2.315
----	---	--------------	--	--	--	--	--------------



16886

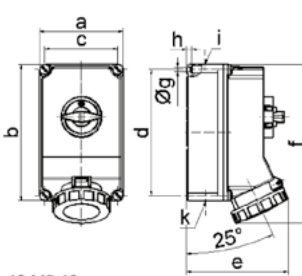

12 MB 10

Ampere Polzahl	63 3	63 4	63 5
a	160,0	160,0	160,0
b	260,0	260,0	260,0
c	140,0	140,0	140,0
d	240,0	240,0	240,0
e	195,0	195,0	195,0
f	304,0	304,0	304,0
g ø	8,1	8,1	8,1
h	10,0	10,0	10,0
i	M40	M40	M40
k	M32/40	M32/40	M32/40

CEE-inbouwcontactdoos

- Schroefloze klemmen
- KONTEX contact
- Flensafmeting 75X75mm
- Beschermingsklasse IP44

QUICK CONNECT



132002

	Ampere	Polen	110V	230V	400V	500V	>50V	>50V	kg
			50-60 Hz	50-60 Hz	50-60 Hz	50-60 Hz	301-500Hz	100-300Hz	
			3pol 4pol 5pol 4h 4h 4h	3pol 4pol 5pol 6h 9h 9h	3pol 4pol 5pol 9h 6h 6h	3pol 4pol 5pol 7h 7h 7h	3pol 4pol 5pol 2h 2h 2h	3pol 4pol 5pol 10h 10h 10h	Gewicht
16	3		13685	13686	13687	13688	13690	13689	0.102
16	4		13691	13692	13693	13694	13696	13695	0.125
16	5		13697	13698	132001	13699	13701	13700	0.130
32	3		13702	13703	13704	13705	13707	13706	0.170
32	4		13708	13709	13710	13711	13713	13712	0.181
32	5		13714	13715	132002	13716	13718	13717	0.225

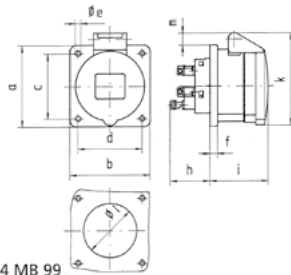

4 MB 99

Ampere	16	16	16	32	32	32
Polzahl	3	4	5	3	4	5
a	75,0	75,0	75,0	75,0	75,0	75,0
b	75,0	75,0	75,0	75,0	75,0	75,0
c	60,0	60,0	60,0	60,0	60,0	60,0
d	60,0	60,0	60,0	60,0	60,0	60,0
e ø	5,5	5,5	5,5	5,5	5,5	5,5
f	7,0	7,0	7,0	8,0	8,0	8,0
h	35,5	35,5	35,5	50,0	50,0	50,0
i	50,0	50,0	51,0	60,0	60,0	60,0
k	74,0	84,0	91,0	94,0	94,0	102,0
l ø	45,0	45,0	55,0	60,0	60,0	60,0
m	3,5	7,0	11,5	12,0	12,0	17,0
Leiter mm² min	1,5	1,5	1,5	2,5	2,5	2,5
Leiter mm² max	4	4	4	10	10	10

CEE-inbouwcontactdoos

- Schroefloze klemmen
- KONTEX contact
- Flensafmeting 56x56 mm bij 16A 3p, 60x60mm bij 16A 4p
- Beschermingsklasse IP44

QUICK CONNECT



13663

	Ampere	Polen	110V	230V	400V	500V	>50V	>50V	kg
			50-60 Hz	50-60 Hz	50-60 Hz	50-60 Hz	301-500Hz	100-300Hz	
			3pol 4pol 5pol 4h 4h 4h	3pol 4pol 5pol 6h 9h 9h	3pol 4pol 5pol 9h 6h 6h	3pol 4pol 5pol 7h 7h 7h	3pol 4pol 5pol 2h 2h 2h	3pol 4pol 5pol 10h 10h 10h	Gewicht
16	3		13656	13646	13657	13658	13660	13659	0.080
16	4		13661	13662	13663	13664	13666	13665	0.109

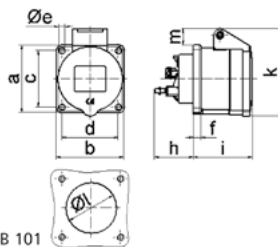

4 MB 101

Ampere	16	16
Polzahl	3	4
a	56,0	60,0
b	56,0	60,0
c	44,0	50 - 52
d	44,0	50 - 52
e ø	4,4	5,5
f	7,0	7,0
h	35,5	35,5
i	51,0	53,0
k	70,0	80,0
l ø	45,0	45,0
m	13,0	9,0
Leiter mm² min	1,5	1,5
Leiter mm² max	4	4

CEE-inbouwcontactdoos

- Schroefloze klemmen
- KONTEX contact
- Flensafmeting 62x62mm bij 16A 3p, 72x65mm bij 16A 4/5p
- Beschermingsklasse IP44

QUICK CONNECT



13681

	Ampere	Polen	110V	230V	400V	500V	>50V	>50V	kg
			50-60 Hz	50-60 Hz	50-60 Hz	50-60 Hz	301-500Hz	100-300Hz	
			3pol 4pol 5pol 4h 4h 4h	3pol 4pol 5pol 6h 9h 9h	3pol 4pol 5pol 9h 6h 6h	3pol 4pol 5pol 7h 7h 7h	3pol 4pol 5pol 2h 2h 2h	3pol 4pol 5pol 10h 10h 10h	Gewicht
16	3		13667	13668	13669	13670	13672	13671	0.095
16	4		13673	13674	13675	13676	13678	13677	0.115
16	5		13679	13680	13681	13682	13684	13683	0.131

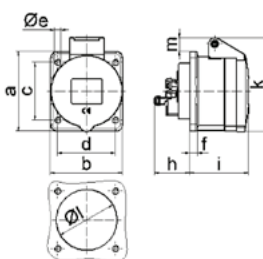

4 MB 100

Ampere	16	16	16
Polzahl	3	4	5
a	62,0	72,0	72,0
b	62,0	65,0	65,0
c	47,0	52,0	52,0
d	47,0	52,0	52,0
e ø	5,5	5,5	5,5
f	7,0	7,0	7,0
h	35,5	35,5	35,5
i	51,0	53,0	53,0
k	70,0	80,0	85,0
l ø	45,0	45,0	55,0
m	10,0	9,0	13,0
Leiter mm² min	1,5	1,5	1,5
Leiter mm² max	4	4	4

CEE-inbouwcontactdoos

- Schroefloze klemmen
- KONTEX contact
- Flensafmeting 70X70mm
- Beschermingsklasse IP44

		110V 50-60 Hz	230V 50-60 Hz	400V 50-60 Hz	500V 50-60 Hz	>50V 301-500Hz	>50V 100-300Hz	kg
		3pol 4pol 5pol 4h 4h 4h	3pol 4pol 5pol 6h 9h 9h	3pol 4pol 5pol 9h 6h 6h	3pol 4pol 5pol 7h 7h 7h	3pol 4pol 5pol 2h 2h 2h	3pol 4pol 5pol 10h 10h 10h	Gewicht
16	5	13895						0.146
32	5	13896						0.205

QUICK CONNECT



13895

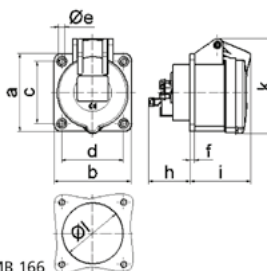

4 MB 166

Ampere	16	32					
Polzahl	5	5					
a	70,0	70,0					
b	70,0	70,0					
c	56,0	56,0					
d	56,0	56,0					
e ø	5,2	5,2					
f	4,0	4,0					
h	35,5	46,0					
i	57,0	66,0					
k	86,0	99,0					
l ø	55,0	60,0					
Leiter mm² min	1,5	2,5					
Leiter mm² max	4	10					

CEE-inbouwcontactdoos

- Schroefklemmen
- Flensafmeting 107x100mm
- KONTEX contact
- Vernikkelde contacten
- Raamklemmen
- Beschermingsklasse IP44
- Bij wandcontactdozen met Pilot graag een -P toevoegen aan het artikelnummer

		110V 50-60 Hz	230V 50-60 Hz	400V 50-60 Hz	500V 50-60 Hz	>50V 301-500Hz	>50V 100-300Hz	kg
		3pol 4pol 5pol 4h 4h 4h	3pol 4pol 5pol 6h 9h 9h	3pol 4pol 5pol 9h 6h 6h	3pol 4pol 5pol 7h 7h 7h	3pol 4pol 5pol 2h 2h 2h	3pol 4pol 5pol 10h 10h 10h	Gewicht
63	3	1306	1307	1308	13592			0.400
63	4		1304	134	1301			0.445
63	5	13140	1305	136	13168	13051		0.530



136

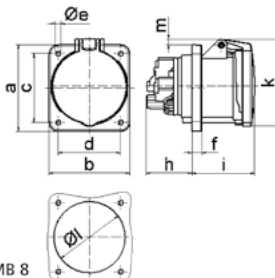

4 MB 8

Ampere	63	63	63				
Polzahl	3	4	5				
a	107,0	107,0	107,0				
b	100,0	100,0	100,0				
c	85,0	85,0	85,0				
d	77,0	77,0	77,0				
e ø	6,5	6,5	6,5				
f	12,0	12,0	12,0				
h	56,5	56,5	56,5				
i	77,0	77,0	77,0				
k	110,0	110,0	110,0				
l ø	88,0	88,0	88,0				
m	7,0	7,0	7,0				
Leiter mm² min	6	6	6				
Leiter mm² max	25	25	25				

CEE-inbouwcontactdoos

- Schroefloze klemmen
- Hoek 20°
- KONTEX contact
- Flensafmeting 68x62mm bij 16A 3p, 87x71mm bij 16A 4/5p
- Beschermingsklasse IP44

QUICK CONNECT



12741

Ampere	Polen	110V 50-60 Hz	230V 50-60 Hz	400V 50-60 Hz	500V 50-60 Hz	>50V 301-500Hz	>50V 100-300Hz	kg Gewicht
		3pol 4pol 5pol 4h 4h 4h	3pol 4pol 5pol 6h 9h 9h	3pol 4pol 5pol 9h 6h 6h	3pol 4pol 5pol 7h 7h 7h	3pol 4pol 5pol 2h 2h 2h	3pol 4pol 5pol 10h 10h 10h	
16	3	12731	12732					0.095
16	4	12733	12734	12735	12736			0.122
16	5	12739	12740	12741	12742			0.140

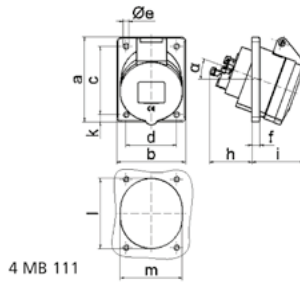

Ampere	16	16	16
Polzahl	3	4	5
a	68,0	87,0	87,0
b	62,0	71,0	71,0
c	47,0	70,0	70,0
d	47,0	52,0	52,0
e ø	5,5	5,5	5,5
f	8,0	5,5	5,5
h	46,0	46,0	46,0
i	50,0	54,0	54,0
k	-	9,5	9,5
l	56,0	65,0	72,0
m	51,0	58,0	64,0
α	20°	20°	20°
Leiter mm² min	1,5	1,5	1,5
Leiter mm² max	4	4	4

CEE-inbouwcontactdoos

- Schroefloze klemmen
- Hoek 20°
- KONTEX contact
- Flensafmeting 75x75mm
- Beschermingsklasse IP44

QUICK CONNECT



122001

Ampere	Polen	110V 50-60 Hz	230V 50-60 Hz	400V 50-60 Hz	500V 50-60 Hz	>50V 301-500Hz	>50V 100-300Hz	kg Gewicht
		3pol 4pol 5pol 4h 4h 4h	3pol 4pol 5pol 6h 9h 9h	3pol 4pol 5pol 9h 6h 6h	3pol 4pol 5pol 7h 7h 7h	3pol 4pol 5pol 2h 2h 2h	3pol 4pol 5pol 10h 10h 10h	
16	5	12743	12744	122001	12745	12747	12746	0.140

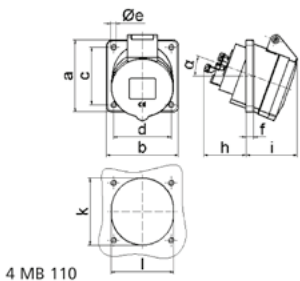

Ampere	16
Polzahl	5
a	75,0
b	75,0
c	60,0
d	60,0
e ø	5,5
f	8,0
h	46,0
i	54,0
k	70,0
l	65,0
α	20°
Leiter mm² min	1,5
Leiter mm² max	4

CEE-inbouwcontactdoos

- Schroefloze klemmen
- Hoek 20°
- KONTEX contact
- Flensafmeting 85x85mm
- Beschermingsklasse IP44

QUICK CONNECT



12757

Ampere	Polen	110V 50-60 Hz	230V 50-60 Hz	400V 50-60 Hz	500V 50-60 Hz	>50V 301-500Hz	>50V 100-300Hz	kg Gewicht
		3pol 4pol 5pol 4h 4h 4h	3pol 4pol 5pol 6h 9h 9h	3pol 4pol 5pol 9h 6h 6h	3pol 4pol 5pol 7h 7h 7h	3pol 4pol 5pol 2h 2h 2h	3pol 4pol 5pol 10h 10h 10h	
16	3	12748	12749	12750	12751	12752	12861	0.120
16	4	12862	12863	12753	12864	12865	12754	0.131
16	5	12755	12756	12757	12758	12759	12866	0.150
32	3	12760	12761	12867	12762	12869	12868	0.185
32	4	12870	12763	12764	12765	12872	12871	0.191
32	5	12766	12767	12768	12769	12873	12770	0.235

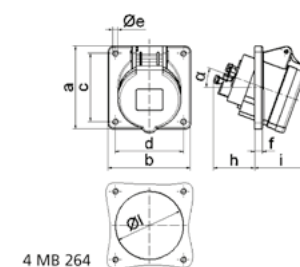

Ampere	16	16	16	32	32	32
Polzahl	3	4	5	3	4	5
a	85,0	85,0	85,0	85,0	85,0	85,0
b	85,0	85,0	85,0	85,0	85,0	85,0
c	70,0	70,0	70,0	70,0	70,0	70,0
d	70,0	70,0	70,0	70,0	70,0	70,0
e ø	5,5	5,5	5,5	5,5	5,5	5,5
f	8,0	8,0	8,0	8,0	8,0	8,0
h	46,0	46,0	46,0	55,0	55,0	55,0
i	50,0	51,0	54,0	60,0	60,0	60,0
l ø	57,0	65,0	70,0	78,0	78,0	78,0
α	20°	20°	20°	20°	20°	20°
Leiter mm² min	1,5	1,5	1,5	2,5	2,5	2,5
Leiter mm² max	4	4	4	10	10	10

CEE-inbouwcontactdoos

- Schroefloze klemmen
- Hoek 20°
- KONTEX contact
- Flensafmeting 74x62mm bij 16A 3p, 100x92mm bij de andere uitvoeringen
- Beschermingsklasse IP44

QUICK CONNECT



12730

		110V 50-60 Hz			230V 50-60 Hz			400V 50-60 Hz			500V 50-60 Hz			>50V 301-500Hz			>50V 100-300Hz			kg Gewicht
		3pol	4pol	5pol	3pol	4pol	5pol	3pol	4pol	5pol	3pol	4pol	5pol	3pol	4pol	5pol	3pol	4pol	5pol	
16	3	12771	12772	12773	12774	12776	12775							0.096						
16	4	12777	12778	12779	12780	12782	12781							0.140						
16	5	12783	12784	12730	12785	12787	12786							0.158						
32	3	12788	12789	12790	12874	12792	12791							0.195						
32	4	12793	12794	12795	12796	12798	12797							0.210						
32	5	12799	12800	12801	12802	12804	12803							0.240						

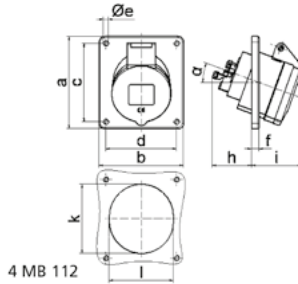

Ampere	16	16	16	32	32	32
Polzahl	3	4	5	3	4	5
a	74,0	100,0	100,0	100,0	100,0	100,0
b	62,0	92,0	92,0	92,0	92,0	92,0
c	60,0	85,0	85,0	85,0	85,0	85,0
d	52,0	77,0	77,0	77,0	77,0	77,0
e ø	5,5	5,5	5,5	5,5	5,5	5,5
f	8,0	8,0	8,0	8,0	8,0	8,0
h	46,0	46,0	46,0	55,0	55,0	55,0
i	48,0	50,0	55,0	68,0	68,0	60,0
k	57,0	65,0	70,0	75,0	75,0	78,0
l	52,0	65,0	70,0	75,0	75,0	78,0
α	20°	20°	20°	20°	20°	20°
Leiter mm² min	1,5	1,5	1,5	2,5	2,5	2,5
Leiter mm² max	4	4	4	10	10	10

CEE-inbouwcontactdoos

- Schroefloze klemmen
- Hoek 20°
- KONTEX contact
- Flensafmeting 110x110mm
- Beschermingsklasse IP44

QUICK CONNECT



12805

		110V 50-60 Hz			230V 50-60 Hz			400V 50-60 Hz			500V 50-60 Hz			>50V 301-500Hz			>50V 100-300Hz			kg Gewicht
		3pol	4pol	5pol	3pol	4pol	5pol	3pol	4pol	5pol	3pol	4pol	5pol	3pol	4pol	5pol	3pol	4pol	5pol	
16	5							12805							0.183					
32	5							12806							0.247					

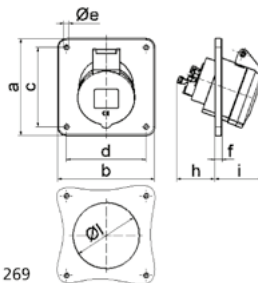

Ampere	16	32
Polzahl	5	5
a	110,0	110,0
b	110,0	110,0
c	90,0	90,0
d	90,0	90,0
e ø	5,5	5,5
f	8,0	8,0
h	46,0	55,0
i	56,0	60,0
l ø	75,0	78,0
Leiter mm² min	1,5	2,5
Leiter mm² max	4	10

CEE-inbouwcontactdoos

- Schroefklemmen
- Hoek 15°
- Flensafmeting 100x92mm
- KONTEX contact
- Raamklemmen
- Vernikkelde contacten
- Beschermingsklasse IP44
- Bij wandcontactdozen met Pilot graag een -P toevoegen aan het artikelnummer

12567



		110V 50-60 Hz			230V 50-60 Hz			400V 50-60 Hz			500V 50-60 Hz			>50V 301-500Hz			>50V 100-300Hz			kg Gewicht
		3pol	4pol	5pol	3pol	4pol	5pol	3pol	4pol	5pol	3pol	4pol	5pol	3pol	4pol	5pol	3pol	4pol	5pol	
63	3							12563							0.415					
63	4							12074	12565							0.430				
63	5	12566	12568	12567							0.470									

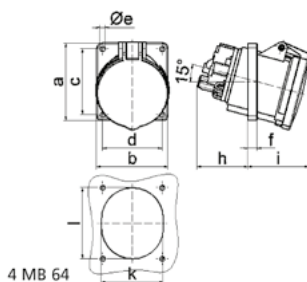

Ampere	63	63	63
Polzahl	3	4	5
a	100,0	100,0	100,0
b	92,0	92,0	92,0
c	85,0	85,0	85,0
d	77,0	77,0	77,0
e ø	6,5	6,5	6,5
f	12,0	12,0	12,0
h	65,0	65,0	65,0
i	81,0	81,0	81,0
k	80,0	80,0	80,0
l	92,0	92,0	92,0
Leiter mm² min	6	6	6
Leiter mm² max	25	25	25

CEE-inbouwcontactdoos

- Schroefklemmen
- Hoek 15°
- Flensafmeting 114x114mm
- KONTEX contact
- Raamklemmen
- Vernikkelde contacten
- Beschermingsklasse IP44
- Bij wandcontactdozen met Pilot graag een -P toevoegen aan het artikelnummer



1202

		110V 50-60 Hz	230V 50-60 Hz	400V 50-60 Hz	500V 50-60 Hz	>50V 301-500Hz	>50V 100-300Hz	kg
		3pol 4pol 5pol 4h 4h 4h	3pol 4pol 5pol 6h 9h 9h	3pol 4pol 5pol 9h 6h 6h	3pol 4pol 5pol 7h 7h 7h	3pol 4pol 5pol 2h 2h 2h	3pol 4pol 5pol 10h 10h 10h	Gewicht
63	3	12134	12135	12136				0.420
63	4	12137	1207	1201	1204			0.460
63	5	12138	1208	1202	12195			0.500

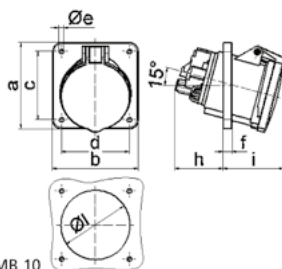

Ampere	63	63	63
Polzahl	3	4	5
a	114,0	114,0	114,0
b	114,0	114,0	114,0
c	90,0	90,0	90,0
d	90,0	90,0	90,0
e ø	6,5	6,5	6,5
f	12,0	12,0	12,0
h	65,0	65,0	65,0
i	81,0	81,0	81,0
l	92,0	92,0	92,0
Leiter mm² min	6	6	6
Leiter mm² max	25	25	25

CEE-inbouwcontactdoos

- Schroefklemmen
- Hoek 15°
- Flensafmeting 114x114mm
- Hittebestendige contactdragers
- Kontex contact
- Vernikkelde contacten
- Raamklemmen
- Beschermingsklasse IP44



120306

		110V 50-60 Hz	230V 50-60 Hz	400V 50-60 Hz	500V 50-60 Hz	>50V 301-500Hz	>50V 100-300Hz	kg
		3pol 4pol 5pol 4h 4h 4h	3pol 4pol 5pol 6h 9h 9h	3pol 4pol 5pol 9h 6h 6h	3pol 4pol 5pol 7h 7h 7h	3pol 4pol 5pol 2h 2h 2h	3pol 4pol 5pol 10h 10h 10h	Gewicht
63	5			120306				0.620

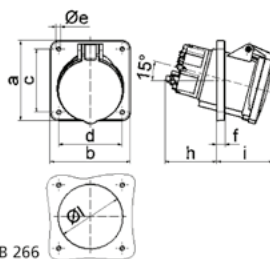

Ampere	63	63
Polzahl	4	5
a	114,0	114,0
b	114,0	114,0
c	90,0	90,0
d	90,0	90,0
e ø	6,5	6,5
f	12,0	12,0
h	74,0	74,0
i	81,0	81,0
l ø	92,0	92,0
Leiter mm² min	6	6
Leiter mm² max	25	25

CEE-inbouwcontactdoos

- Schroefloze klemmen
- KONTEX contact
- Flensafmeting 62x62mm bij 16A 3p, 72x65mm bij 16A 4/5p
- Beschermingsklasse IP67

QUICK CONNECT



13732

		110V 50-60 Hz			230V 50-60 Hz			400V 50-60 Hz			500V 50-60 Hz			>50V 301-500Hz			>50V 100-300Hz			kg Gewicht
		3pol	4pol	5pol	3pol	4pol	5pol	3pol	4pol	5pol	3pol	4pol	5pol	3pol	4pol	5pol	3pol	4pol	5pol	
16	3	13719	13720	13721															0.117	
16	4	13724	13725	13726	13727														0.139	
16	5	13730	13731	13732															0.170	

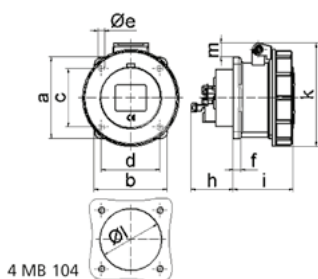

Ampere	16	16	16			
Polzahl	3	4	5			
a	62,0	72,0	72,0			
b	62,0	65,0	65,0			
c	47,0	52,0	52,0			
d	47,0	52,0	52,0			
e ø	5,5	5,5	5,5			
f	7,0	7,0	7,0			
h	35,5	35,5	35,5			
i	57,0	58,0	57,0			
k	76,0	83,0	93,0			
l ø	45,0	45,0	55,0			
m	10,0	9,0	13,0			
Leiter mm² min	1,5	1,5	1,5			
Leiter mm² max	4	4	4			

CEE-inbouwcontactdoos

- Schroefloze klemmen
- KONTEX contact
- Flensafmeting 75x75mm
- Beschermingsklasse IP67

QUICK CONNECT



13745

		110V 50-60 Hz			230V 50-60 Hz			400V 50-60 Hz			500V 50-60 Hz			>50V 301-500Hz			>50V 100-300Hz			kg Gewicht
		3pol	4pol	5pol	3pol	4pol	5pol	3pol	4pol	5pol	3pol	4pol	5pol	3pol	4pol	5pol	3pol	4pol	5pol	
16	3	13733	13734	13735															0.155	
16	4	13737	13738	13739	13740	13742	13741												0.145	
16	5	13743	13744	13745	13746	13748													0.172	
32	3	13749	13750	13751															0.207	
32	4	13754	13755	13756	13757	13758													0.217	
32	5	13760	13761	13762	13763	13765	13764												0.290	

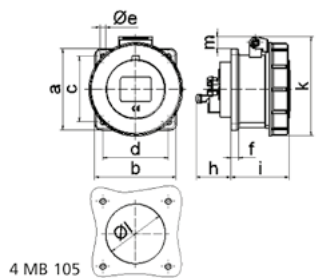

Ampere	16	16	16	32	32	32
Polzahl	3	4	5	3	4	5
a	75,0	75,0	75,0	75,0	75,0	75,0
b	75,0	75,0	75,0	75,0	75,0	75,0
c	60,0	60,0	60,0	60,0	60,0	60,0
d	60,0	60,0	60,0	60,0	60,0	60,0
e ø	5,5	5,5	5,5	5,5	5,5	5,5
f	7,0	7,0	7,0	8,0	8,0	8,0
h	35,5	35,5	35,5	46,0	46,0	46,0
i	57,0	58,0	57,0	65,0	65,0	65,0
k	76,0	83,0	93,0	100,0	100,0	106,0
l ø	45,0	45,0	55,0	60,0	60,0	60,0
m	3,5	7,0	11,5	12,0	12,0	17,0
Leiter mm² min	1,5	1,5	1,5	2,5	2,5	2,5
Leiter mm² max	4	4	4	10	10	10

CEE-inbouwcontactdoos

- Schroefklemmen
- Flensafmeting 107x100mm
- KONTEX contact
- Vernikkelde contacten
- Raamklemmen
- Beschermingsklasse IP67
- Bij wandcontactdozen met Pilot graag een -P toevoegen aan het artikelnummer

13104



		110V 50-60 Hz			230V 50-60 Hz			400V 50-60 Hz			500V 50-60 Hz			>50V 301-500Hz			>50V 100-300Hz			kg Gewicht
		3pol	4pol	5pol	3pol	4pol	5pol	3pol	4pol	5pol	3pol	4pol	5pol	3pol	4pol	5pol	3pol	4pol	5pol	
63	3	1395	1396	1397															0.485	
63	4	1398	1399	13100	13101														0.490	
63	5	13102	13103	13104															0.535	

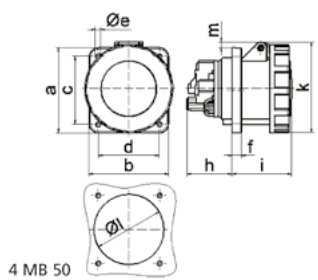

Ampere	63	63	63			
Polzahl	3	4	5			
a	107,0	107,0	107,0			
b	100,0	100,0	100,0			
c	85,0	85,0	85,0			
d	77,0	77,0	77,0			
e ø	6,5	6,5	6,5			
f	12,0	12,0	12,0			
h	56,5	56,5	56,5			
i	76,0	76,0	76,0			
k	113,0	113,0	113,0			
l ø	88,0	88,0	88,0			
m	7,0	7,0	7,0			
Leiter mm² min	6	6	6			
Leiter mm² max	25	25	25			

CEE-inbouwcontactdoos

- Schroefklemmen
- Flensafmeting 120x120mm
- Hittebestendige contactdragers
- KONTEX contact
- Vernikkelde contacten
- Raamklemmen
- Beschermingsklasse IP67
- Bij wandcontactdozen met Pilot graag een -P toevoegen aan het artikelnummer



13451

	110V 50-60 Hz	230V 50-60 Hz	400V 50-60 Hz	500V 50-60 Hz	>50V 301-500Hz	>50V 100-300Hz	kg
	3pol 4pol 5pol 4h 4h 4h	3pol 4pol 5pol 6h 9h 9h	3pol 4pol 5pol 9h 6h 6h	3pol 4pol 5pol 7h 7h 7h	3pol 4pol 5pol 2h 2h 2h	3pol 4pol 5pol 10h 10h 10h	Gewicht
125 3	13445	13452					0.930
125 4		13449	13447	13448			1.010
125 5			13451				1.125

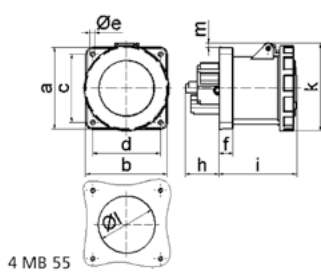

Ampere Polzahl	125 3	125 4	125 5
a	120,0	120,0	120,0
b	120,0	120,0	120,0
c	100,0	100,0	100,0
d	100,0	100,0	100,0
e ø	6,5	6,5	6,5
f	21,0	21,0	21,0
h	50,0	50,0	50,0
i	117,0	117,0	117,0
k	129,0	129,0	129,0
l ø	104,0	104,0	104,0
m	6,0	6,0	6,0
Leiter mm² min	25	25	25
Leiter mm² max	70	70	70

CEE-inbouwcontactdoos

- Schroefklemmen
- Flensafmeting 130x130mm
- Hittebestendige contactdragers
- KONTEX contact
- Vernikkelde contacten
- Raamklemmen
- Beschermingsklasse IP67
- Bij wandcontactdozen met Pilot graag een -P toevoegen aan het artikelnummer



13436

	110V 50-60 Hz	230V 50-60 Hz	400V 50-60 Hz	500V 50-60 Hz	>50V 301-500Hz	>50V 100-300Hz	kg
	3pol 4pol 5pol 4h 4h 4h	3pol 4pol 5pol 6h 9h 9h	3pol 4pol 5pol 9h 6h 6h	3pol 4pol 5pol 7h 7h 7h	3pol 4pol 5pol 2h 2h 2h	3pol 4pol 5pol 10h 10h 10h	Gewicht
125 3		13434					0.900
125 4		13442	13435	13515			1.036
125 5			13436				1.139

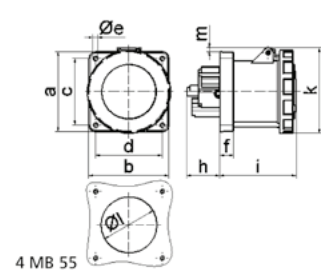

Ampere Polzahl	125 3	125 4	125 5
a	130,0	130,0	130,0
b	130,0	130,0	130,0
c	104,0	104,0	104,0
d	104,0	104,0	104,0
e ø	6,5	6,5	6,5
f	21,0	21,0	21,0
h	50,0	50,0	50,0
i	117,0	117,0	117,0
k	129,0	129,0	129,0
l ø	104,0	104,0	104,0
m	1,0	1,0	1,0
Leiter mm² min	25	25	25
Leiter mm² max	70	70	70

CEE-inbouwcontactdoos

- Schroefloze klemmen
- Hoek 20°
- KONTEX contact
- Flensafmeting 68x62mm bij 16A 3p, 75x75mm bij 16A 5p
- Beschermingsklasse IP67

QUICK CONNECT



12812

		110V 50-60 Hz	230V 50-60 Hz	400V 50-60 Hz	500V 50-60 Hz	>50V 301-500Hz	>50V 100-300Hz	kg
		3pol 4pol 5pol 4h 4h 4h	3pol 4pol 5pol 6h 9h 9h	3pol 4pol 5pol 9h 6h 6h	3pol 4pol 5pol 7h 7h 7h	3pol 4pol 5pol 2h 2h 2h	3pol 4pol 5pol 10h 10h 10h	Gewicht
16	3	12808	12809					0.122
16	5	12810	12811	12812				0.184

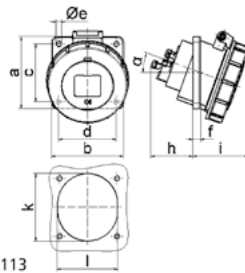

4 MB 113

Ampere	16	16					
Polzahl	3	5					
a	68,0	75,0					
b	62,0	75,0					
c	47,0	60,0					
d	47,0	60,0					
e ø	5,5	5,5					
f	8,0	5,5					
h	46,0	46,0					
i	57,0	60,0					
k	56,0	70,0					
l	51,0	63,0					
α	20°	20°					
Leiter mm² min	1,5	1,5					
Leiter mm² max	4	4					

CEE-inbouwcontactdoos

- Schroefloze klemmen
- Hoek 20°
- KONTEX contact
- Flensafmeting 85x85mm
- Beschermingsklasse IP67

QUICK CONNECT



12817

		110V 50-60 Hz	230V 50-60 Hz	400V 50-60 Hz	500V 50-60 Hz	>50V 301-500Hz	>50V 100-300Hz	kg
		3pol 4pol 5pol 4h 4h 4h	3pol 4pol 5pol 6h 9h 9h	3pol 4pol 5pol 9h 6h 6h	3pol 4pol 5pol 7h 7h 7h	3pol 4pol 5pol 2h 2h 2h	3pol 4pol 5pol 10h 10h 10h	Gewicht
16	3	12917	12813					0.148
16	4		12929	12814	12930			0.168
16	5	12815	12816	12817				0.200
32	3	12818	12819					0.241
32	4		12820	12821	12931			0.250
32	5	12822	12823	12824				0.289

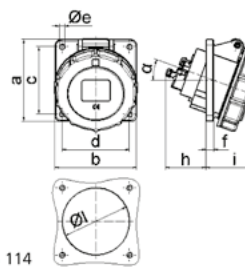

4 MB 114

Ampere	16	16	16	32	32	32
Polzahl	3	4	5	3	4	5
a	85,0	85,0	85,0	85,0	85,0	85,0
b	85,0	85,0	85,0	85,0	85,0	85,0
c	70,0	70,0	70,0	70,0	70,0	70,0
d	70,0	70,0	70,0	70,0	70,0	70,0
e ø	5,5	5,5	5,5	5,5	5,5	5,5
f	8,0	8,0	8,0	8,0	8,0	8,0
h	46,0	46,0	46,0	55,0	55,0	55,0
i	57,0	57,0	60,0	65,0	65,0	69,0
l ø	57,0	65,0	70,0	78,0	78,0	78,0
α	20°	20°	20°	20°	20°	20°
Leiter mm² min	1,5	1,5	1,5	2,5	2,5	2,5
Leiter mm² max	4	4	4	10	10	10

CEE-inbouwcontactdoos

- Schroefloze klemmen
- Hoek 20°
- KONTEX contact
- Flensafmeting 74x62mm bij 16A 3p, 100x92mm bij de andere uitvoeringen
- Beschermingsklasse IP67

QUICK CONNECT



12839

		110V 50-60 Hz	230V 50-60 Hz	400V 50-60 Hz	500V 50-60 Hz	>50V 301-500Hz	>50V 100-300Hz	kg
		3pol 4pol 5pol 4h 4h 4h	3pol 4pol 5pol 6h 9h 9h	3pol 4pol 5pol 9h 6h 6h	3pol 4pol 5pol 7h 7h 7h	3pol 4pol 5pol 2h 2h 2h	3pol 4pol 5pol 10h 10h 10h	Gewicht
16	3	12825	12826	12839				0.123
16	4	12831	12832	12833	12834	12836	12835	0.164
16	5	12837	12838		12840	12842		0.195
32	3	12843	12844					0.258
32	4	12846	12847	12848	12849		12850	0.275
32	5	12852	12853	12854	12855	12857	12856	0.285

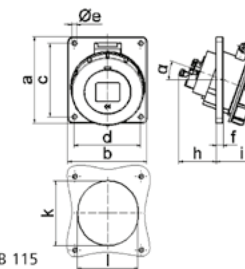

4 MB 115

Ampere	16	16	16	32	32	32
Polzahl	3	4	5	3	4	5
a	74,0	100,0	100,0	100,0	100,0	100,0
b	62,0	92,0	92,0	92,0	92,0	92,0
c	60,0	85,0	85,0	85,0	85,0	85,0
d	52,0	77,0	77,0	77,0	77,0	77,0
e ø	5,5	5,5	5,5	5,5	5,5	5,5
f	8,0	8,0	8,0	8,0	8,0	8,0
h	46,0	46,0	46,0	55,0	55,0	55,0
i	57,0	57,0	60,0	65,0	65,0	69,0
k	57,0	65,0	70,0	75,0	75,0	78,0
l	52,0	65,0	70,0	75,0	75,0	78,0
α	20°	20°	20°	20°	20°	20°
Leiter mm² min	1,5	1,5	1,5	2,5	2,5	2,5
Leiter mm² max	4	4	4	10	10	10

CEE-inbouwcontactdoos

- Schroefklemmen
- Hoek 15°
- Flensafmeting 100x92mm
- KONTEX contact
- Vernikkelde contacten
- Raamklemmen
- Beschermingsklasse IP67
- Bij wandcontactdozen met Pilot graag een -P toevoegen aan het artikelnummer



12574

		110V 50-60 Hz	230V 50-60 Hz	400V 50-60 Hz	500V 50-60 Hz	>50V 301-500Hz	>50V 100-300Hz	kg
		3pol 4pol 5pol 4h 4h 4h	3pol 4pol 5pol 6h 9h 9h	3pol 4pol 5pol 9h 6h 6h	3pol 4pol 5pol 7h 7h 7h	3pol 4pol 5pol 2h 2h 2h	3pol 4pol 5pol 10h 10h 10h	Gewicht
63	3	12569						0.445
63	4		12032	12570	12571		0.595	
63	5	12572	12573	12574			0.525	

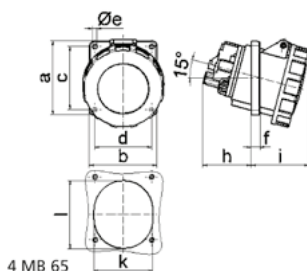

Ampere	63	63	63
Polzahl	3	4	5
a	100,0	100,0	100,0
b	92,0	92,0	92,0
c	85,0	85,0	85,0
d	77,0	77,0	77,0
e ø	6,5	6,5	6,5
f	12,0	12,0	12,0
h	65,0	65,0	65,0
i	80,0	80,0	80,0
k	80,0	80,0	80,0
l	92,0	92,0	92,0
Leiter mm² min	6	6	6
Leiter mm² max	25	25	25

CEE-inbouwcontactdoos

- Schroefklemmen
- Hoek 15°
- Flensafmeting 114x114mm
- KONTEX contact
- Vernikkelde contacten
- Raamklemmen
- Beschermingsklasse IP67
- Bij wandcontactdozen met Pilot graag een -P toevoegen aan het artikelnummer



129

		110V 50-60 Hz	230V 50-60 Hz	400V 50-60 Hz	500V 50-60 Hz	>50V 301-500Hz	>50V 100-300Hz	kg
		3pol 4pol 5pol 4h 4h 4h	3pol 4pol 5pol 6h 9h 9h	3pol 4pol 5pol 9h 6h 6h	3pol 4pol 5pol 7h 7h 7h	3pol 4pol 5pol 2h 2h 2h	3pol 4pol 5pol 10h 10h 10h	Gewicht
63	3	12000	12001	12002				0.530
63	4		1205	1200	1203		12035	0.510
63	5	12004	1206	129	12039	12171		0.550

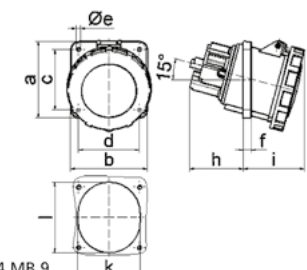

Ampere	63	63	63
Polzahl	3	4	5
a	114,0	114,0	114,0
b	114,0	114,0	114,0
c	90,0	90,0	90,0
d	90,0	90,0	90,0
e ø	6,5	6,5	6,5
f	12,0	12,0	12,0
h	65,0	65,0	65,0
i	80,0	80,0	80,0
k	92,0	92,0	92,0
l	92,0	92,0	92,0
Leiter mm² min	6	6	6
Leiter mm² max	25	25	25

CEE-inbouwcontactdoos TE

- Schroefloze klemmen
- Hoek 15°
- Flensafmeting 114x114mm
- Hittebestendige contactdragers
- KONTEX contact
- Vernikkelde contacten
- Raamklemmen
- Beschermingsklasse IP67



120307

		110V 50-60 Hz	230V 50-60 Hz	400V 50-60 Hz	500V 50-60 Hz	>50V 301-500Hz	>50V 100-300Hz	kg	
		3pol 4pol 5pol 4h 4h 4h	3pol 4pol 5pol 6h 9h 9h	3pol 4pol 5pol 9h 6h 6h	3pol 4pol 5pol 7h 7h 7h	3pol 4pol 5pol 2h 2h 2h	3pol 4pol 5pol 10h 10h 10h	Gewicht	
63	5	120307							0.680

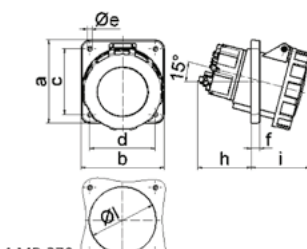

Ampere	63	63
Polzahl	4	5
a	114,0	114,0
b	114,0	114,0
c	90,0	90,0
d	90,0	90,0
e ø	6,5	6,5
f	12,0	12,0
h	74,0	74,0
i	80,0	80,0
l ø	92,0	92,0
Leiter mm² min	6	6
Leiter mm² max	25	25

CEE-inbouwcontactdoos

- Schroefklemmen
- Hoek 15°
- Flensafmeting 114x114mm
- Hittebestendige contactdragers
- KONTEX contact
- Raamklemmen
- Beschermingsklasse IP67
- Bij wandcontactdozen met Pilot graag een -P toevoegen aan het artikelnummer



12108

		110V 50-60 Hz	230V 50-60 Hz	400V 50-60 Hz	500V 50-60 Hz	>50V 301-500Hz	>50V 100-300Hz	kg
		3pol 4pol 5pol 4h 4h 4h	3pol 4pol 5pol 6h 9h 9h	3pol 4pol 5pol 9h 6h 6h	3pol 4pol 5pol 7h 7h 7h	3pol 4pol 5pol 2h 2h 2h	3pol 4pol 5pol 10h 10h 10h	Gewicht
125	3	1299	12100	12101				0.805
125	4		12103	12104	12105		12320	0.890
125	5	12106	12107	12108	12133	12055		1.010

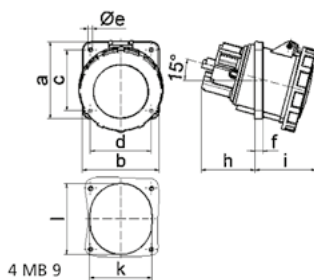

Ampere	63	63	63			
Polzahl	3	4	5			
a	114,0	114,0	114,0			
b	114,0	114,0	114,0			
c	90,0	90,0	90,0			
d	90,0	90,0	90,0			
e o	6,5	6,5	6,5			
f	12,0	12,0	12,0			
h	65,0	65,0	65,0			
i	80,0	80,0	80,0			
k	92,0	92,0	92,0			
l	92,0	92,0	92,0			
Leiter mm² min	6	6	6			
Leiter mm² max	25	25	25			

CEE-inbouwcontactdoos TE

- Schroefloze klemmen
- Hoek 20°
- Met NO en NC contact
- Flensafmeting 85x85mm
- Hittebestendige contactdragers
- Vernikkelde contacten
- Beschermingsklasse IP44

QUICK CONNECT



120587

	Ampere	Polen	110V	230V	400V	500V	>50V	>50V	kg
			50-60 Hz	50-60 Hz	50-60 Hz	50-60 Hz	301-500Hz	100-300Hz	
			3pol 4pol 5pol	3pol 4pol 5pol	3pol 4pol 5pol	3pol 4pol 5pol	3pol 4pol 5pol	3pol 4pol 5pol	
			4h 4h 4h	6h 9h 9h	9h 6h 6h	7h 7h 7h	2h 2h 2h	10h 10h 10h	
16	3		120583	120584					0.175
16	4				120585	120586			0.152
16	5				120587				0.173
32	3		120588	120589					
32	4				120590	120591			0.222
32	5				120592				0.262

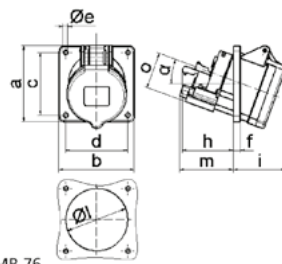

4 MB 76

Ampere	16	16	16	32	32	32
Polzahl	3	4	4	3	4	5
a	85,0	85,0	85,0	85,0	85,0	85,0
b	85,0	85,0	85,0	85,0	85,0	85,0
c	70,0	70,0	70,0	70,0	70,0	70,0
d	70,0	70,0	70,0	70,0	70,0	70,0
e	5,5	5,5	5,5	5,5	5,5	5,5
f	8,0	8,0	8,0	8,0	8,0	8,0
h	46,0	46,0	46,0	61,0	61,0	61,0
i	50,0	51,0	54,0	60,0	60,0	60,0
l	57,0	65,0	70,0	78,0	78,0	78,0
m	57,0	57,0	58,0	62,0	62,0	63,0
o	34,0	37,0	41,0	42,0	42,0	44,0
α	20°	20°	20°	20°	20°	20°

CEE-inbouwcontactdoos TE

- Schroefloze klemmen
- Hoek 20°
- Met NO en NC contact
- Flensafmeting 85x85mm
- Hittebestendige contactdragers
- Vernikkelde contacten
- Beschermingsklasse IP67

QUICK CONNECT



12650

	Ampere	Polen	110V	230V	400V	500V	>50V	>50V	kg
			50-60 Hz	50-60 Hz	50-60 Hz	50-60 Hz	301-500Hz	100-300Hz	
			3pol 4pol 5pol	3pol 4pol 5pol	3pol 4pol 5pol	3pol 4pol 5pol	3pol 4pol 5pol	3pol 4pol 5pol	
			4h 4h 4h	6h 9h 9h	9h 6h 6h	7h 7h 7h	2h 2h 2h	10h 10h 10h	
16	3		12648	121317					0.170
16	4				12649	12653			0.180
16	5				12650				0.216
32	3		12651	12646					0.256
32	4				12555	12652			0.270
32	5				12596				0.308

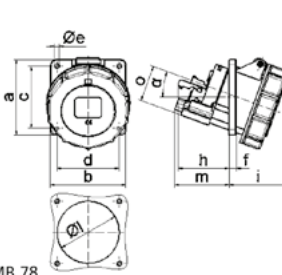

4 MB 78

Ampere	16	16	16	32	32	32
Polzahl	3	4	5	3	4	5
a	85,0	85,0	85,0	85,0	85,0	85,0
b	85,0	85,0	85,0	85,0	85,0	85,0
c	70,0	70,0	70,0	70,0	70,0	70,0
d	70,0	70,0	70,0	70,0	70,0	70,0
e	5,5	5,5	5,5	5,5	5,5	5,5
f	8,0	8,0	8,0	8,0	8,0	8,0
h	46,0	46,0	46,0	55,0	55,0	55,0
i	57,0	57,0	60,0	65,0	65,0	69,0
l	57,0	65,0	70,0	75,0	75,0	78,0
m	57,0	57,0	58,0	62,0	62,0	63,0
o	34,0	37,0	41,0	42,0	42,0	44,0
α	20°	20°	20°	20°	20°	20°

CEE-inbouwcontactdoos

- Schroefklemmen
- Hoek 15°
- Flensafmeting 114x114mm
- Boorgatafstand 90x90mm
- Met PSK vergrendeling
- Kontex plus
- Raamklemmen
- Beschermingsklasse IP67

12025

	Ampere	Polen	110V	230V	400V	500V	>50V	>50V	kg
			50-60 Hz	50-60 Hz	50-60 Hz	50-60 Hz	301-500Hz	100-300Hz	
			3pol 4pol 5pol	3pol 4pol 5pol	3pol 4pol 5pol	3pol 4pol 5pol	3pol 4pol 5pol	3pol 4pol 5pol	
			4h 4h 4h	6h 9h 9h	9h 6h 6h	7h 7h 7h	2h 2h 2h	10h 10h 10h	
63	4				12052	12053			0.600
63	5				12020				0.620
125	4				12139	12054			0.950
125	5				12025				1.050

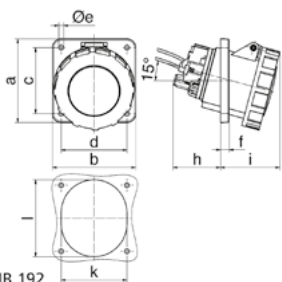

4 MB 192

Ampere	63	63	125	125
Polzahl	4	5	4	5
a	114,0	114,0	114,0	114,0
b	114,0	114,0	114,0	114,0
c	90,0	90,0	90,0	90,0
d	90,0	90,0	90,0	90,0
e o	6,5	6,5	6,5	6,5
f	12,0	12,0	12,0	12,0
h	65,0	65,0	82,0	82,0
i	81,0	81,0	90,0	90,0
k	92,0	92,0	92,0	92,0
l	92,0	92,0	105,0	105,0
Leiter mm² min	6	6	25	25
Leiter mm² max	25	25	70	70

CEE-inbouwcontactdoos TE

- Schroefloze klemmen
- KONTEX contact
- Flensafmeting 75X75mm
- Rechthoekig
- Hittebestendige contactdragers
- Vernikkelde contacten
- Beschermingsklasse IP44

QUICK CONNECT



13336

Ampere	Polen	110V 50-60 Hz			230V 50-60 Hz			400V 50-60 Hz			500V 50-60 Hz			>50V 301-500Hz			>50V 100-300Hz			kg Gewicht
		3pol	4pol	5pol	3pol	4pol	5pol	3pol	4pol	5pol	3pol	4pol	5pol	3pol	4pol	5pol	3pol	4pol	5pol	
16	3																0.113			
16	4																0.131			
16	5																0.149			
32	3																0.187			
32	4																0.185			
32	5																0.216			

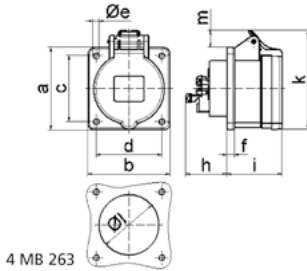

Ampere	Polzahl	16 3	16 4	16 5	32 3	32 4	32 5
a		75,0	75,0	75,0	75,0	75,0	75,0
b		75,0	75,0	75,0	75,0	75,0	75,0
c		60,0	60,0	60,0	60,0	60,0	60,0
d		60,0	60,0	60,0	60,0	60,0	60,0
e ø		5,5	5,5	5,5	5,5	5,5	5,5
f		7,0	7,0	7,0	8,0	8,0	8,0
h		35,5	35,5	35,5	46,0	46,0	46,0
i		50,0	50,0	51,0	60,0	60,0	60,0
k		74,0	84,0	91,0	94,0	94,0	102,0
l ø		45,0	45,0	55,0	60,0	60,0	60,0
m		8,0	12,0	16,0	17,0	17,0	22,0
Leiter mm² min		1,5	1,5	1,5	2,5	2,5	2,5
Leiter mm² max		4	4	4	10	10	10

CEE-inbouwcontactdoos TE

- Schroefklemmen
- Flensafmeting 107x100mm
- Rechthoekig
- Hittebestendige contactdragers
- KONTEX contact en raamklemmen
- Vernikkelde contacten
- Beschermingsklasse IP44
- Bij wandcontactdozen met Pilot graag een -P toevoegen aan het artikelnummer



13343

Ampere	Polen	110V 50-60 Hz			230V 50-60 Hz			400V 50-60 Hz			500V 50-60 Hz			>50V 301-500Hz			>50V 100-300Hz			kg Gewicht
		3pol	4pol	5pol	3pol	4pol	5pol	3pol	4pol	5pol	3pol	4pol	5pol	3pol	4pol	5pol				
63	3																0.495			
63	4																0.555			
63	5																0.630			

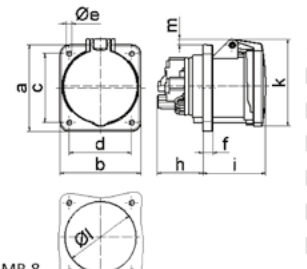

Ampere	Polzahl	63 3	63 4	63 5			
a		107,0	107,0	107,0			
b		100,0	100,0	100,0			
c		85,0	85,0	85,0			
d		77,0	77,0	77,0			
e ø		6,5	6,5	6,5			
f		12,0	12,0	12,0			
h		56,5	56,5	56,5			
i		77,0	77,0	77,0			
k		110,0	110,0	110,0			
l ø		88,0	88,0	88,0			
m		7,0	7,0	7,0			
Leiter mm² min		6	6	6			
Leiter mm² max		25	25	25			

CEE-inbouwcontactdoos TE

- Schroefloze klemmen
- KONTEX contact
- Flensafmeting 74x62 bij 16A 3p, 100x92 bij andere uitvoeringen
- Hoek 20°
- Hittebestendige contactdragers
- Vernikkelde contacten
- Beschermingsklasse IP44

QUICK CONNECT



12884

Ampere	Polen	110V 50-60 Hz			230V 50-60 Hz			400V 50-60 Hz			500V 50-60 Hz			>50V 301-500Hz			>50V 100-300Hz			kg Gewicht
		3pol	4pol	5pol	3pol	4pol	5pol	3pol	4pol	5pol	3pol	4pol	5pol	3pol	4pol	5pol				
16	3																0.108			
16	4																0.147			
16	5																0.166			
32	3																0.200			
32	4																0.215			
32	5																0.221			

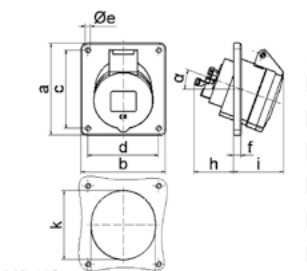

Ampere	Polzahl	16 3	16 4	16 5	32 3	32 4	32 5
a		74,0	100,0	100,0	100,0	100,0	100,0
b		62,0	92,0	92,0	92,0	92,0	92,0
c		60,0	85,0	85,0	85,0	85,0	85,0
d		52,0	77,0	77,0	77,0	77,0	77,0
e ø		5,5	5,5	5,5	5,5	5,5	5,5
f		8,0	8,0	8,0	8,0	8,0	8,0
h		46,0	46,0	46,0	55,0	55,0	55,0
i		48,0	50,0	55,0	68,0	68,0	60,0
k		57,0	65,0	70,0	75,0	75,0	78,0
l		52,0	65,0	70,0	75,0	75,0	78,0
α		20°	20°	20°	20°	20°	20°
Leiter mm² min		1,5	1,5	1,5	2,5	2,5	2,5
Leiter mm² max		4	4	4	10	10	10

CEE-inbouwcontactdoos TE

- Schroefklemmen
- Flensafmeting 114x114mm
- Hoek 15°
- Hittebestendige contactdragers
- KONTEX contact en raamklemmen
- Vernikkelde contacten
- Beschermingsklasse IP44
- Bij wandcontactdozen met Pilot graag een -P toevoegen aan het artikelnummer



12408



110V
50-60 Hz

230V
50-60 Hz

400V
50-60 Hz

500V
50-60 Hz

>50V
301-500Hz

>50V
100-300Hz

kg

Gewicht

63	3	12405	0.510
63	4	12406	0.480
63	5	12408	0.510

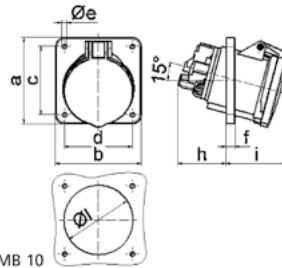

4 MB 10

Ampere	63	63	63
Polzahl	3	4	5
a	114,0	114,0	114,0
b	114,0	114,0	114,0
c	90,0	90,0	90,0
d	90,0	90,0	90,0
e ø	6,5	6,5	6,5
f	12,0	12,0	12,0
h	65,0	65,0	65,0
i	81,0	81,0	81,0
l	92,0	92,0	92,0
Leiter mm² min	6	6	6
Leiter mm² max	25	25	25

CEE-inbouwcontactdoos TE

- Schroefloze klemmen
- KONTEX contact
- Flensafmeting 75x75mm
- Recht
- Hittebestendige contactdragers
- Vernikkelde contacten
- Beschermingsklasse IP67

QUICK CONNECT



13816

Ampere	Polen	110V 50-60 Hz			230V 50-60 Hz			400V 50-60 Hz			500V 50-60 Hz			>50V 301-500Hz			>50V 100-300Hz			kg Gewicht
		3pol	4pol	5pol	3pol	4pol	5pol	3pol	4pol	5pol	3pol	4pol	5pol	3pol	4pol	5pol	3pol	4pol	5pol	
16	3	13156															0.141			
16	4	13083			13157			13810									0.190			
16	5	13159															0.193			
32	3	13812															0.280			
32	4	13813			13814			13815									0.300			
32	5	13816															0.288			

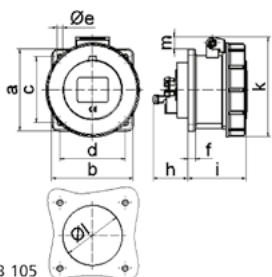

4 MB 105

Ampere	16	16	16	32	32	32
Polzahl	3	4	5	3	4	5
a	75,0	75,0	75,0	75,0	75,0	75,0
b	75,0	75,0	75,0	75,0	75,0	75,0
c	60,0	60,0	60,0	60,0	60,0	60,0
d	60,0	60,0	60,0	60,0	60,0	60,0
e ø	5,5	5,5	5,5	5,5	5,5	5,5
f	7,0	7,0	7,0	8,0	8,0	8,0
h	35,5	35,5	35,5	46,0	46,0	46,0
i	57,0	58,0	57,0	65,0	65,0	65,0
k	76,0	83,0	93,0	100,0	100,0	106,0
l ø	45,0	45,0	55,0	60,0	60,0	60,0
m	3,5	7,0	11,5	12,0	12,0	17,0
Leiter mm² min	1,5	1,5	1,5	2,5	2,5	2,5
Leiter mm² max	4	4	4	10	10	10

CEE-inbouwcontactdoos TE

- Schroefklemmen
- Flensafmeting 107x100mm
- Recht
- Hittebestendige contactdragers
- KONTEX contact en raamklemmen
- Vernikkelde contacten
- Beschermingsklasse IP67
- Bij wandcontactdozen met Pilot graag een -P toevoegen aan het artikelnummer



13385

Ampere	Polen	110V 50-60 Hz			230V 50-60 Hz			400V 50-60 Hz			500V 50-60 Hz			>50V 301-500Hz			>50V 100-300Hz			kg Gewicht
		3pol	4pol	5pol	3pol	4pol	5pol	3pol	4pol	5pol	3pol	4pol	5pol	3pol	4pol	5pol				
63	3	13382															0.535			
63	4	13383			13384												0.595			
63	5	13385															0.551			

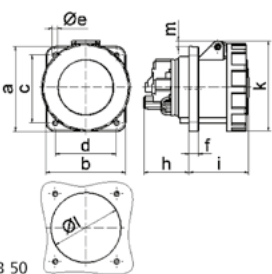

4 MB 50

Ampere	63	63	63			
Polzahl	3	4	5			
a	107,0	107,0	107,0			
b	100,0	100,0	100,0			
c	85,0	85,0	85,0			
d	77,0	77,0	77,0			
e ø	6,5	6,5	6,5			
f	12,0	12,0	12,0			
h	56,5	56,5	56,5			
i	76,0	76,0	76,0			
k	113,0	113,0	113,0			
l ø	88,0	88,0	88,0			
m	7,0	7,0	7,0			
Leiter mm² min	6	6	6			
Leiter mm² max	25	25	25			

CEE-inbouwcontactdoos TE

- Schroefloze klemmen
- KONTEX contact
- Flensafmeting 74x62 bij 16A 3p, 100x92 bij andere uitvoeringen
- Hoek 20°
- Hittebestendige contactdragers
- Vernikkelde contacten
- Beschermingsklasse IP67

QUICK CONNECT



12928

Ampere	Polen	110V 50-60 Hz			230V 50-60 Hz			400V 50-60 Hz			500V 50-60 Hz			>50V 301-500Hz			>50V 100-300Hz			kg Gewicht
		3pol	4pol	5pol	3pol	4pol	5pol	3pol	4pol	5pol	3pol	4pol	5pol	3pol	4pol	5pol				
16	3	12205															0.139			
16	4	12919			12920			12921									0.170			
16	5	120161			12922			120159									0.201			
32	3	12924															0.265			
32	4	12925			12926			12927									0.280			
32	5	120162			12928			120158									0.269			

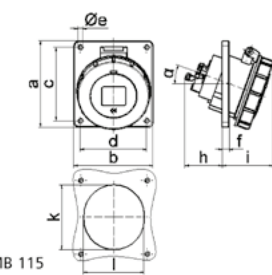

4 MB 115

Ampere	16	16	16	32	32	32
Polzahl	3	4	5	3	4	5
a	74,0	100,0	100,0	100,0	100,0	100,0
b	62,0	92,0	92,0	92,0	92,0	92,0
c	60,0	85,0	85,0	85,0	85,0	85,0
d	52,0	77,0	77,0	77,0	77,0	77,0
e ø	5,5	5,5	5,5	5,5	5,5	5,5
f	8,0	8,0	8,0	8,0	8,0	8,0
h	46,0	46,0	46,0	55,0	55,0	55,0
i	57,0	57,0	60,0	65,0	65,0	69,0
k	57,0	65,0	70,0	75,0	75,0	78,0
l	52,0	65,0	70,0	75,0	75,0	78,0
α	20°	20°	20°	20°	20°	20°
Leiter mm² min	1,5	1,5	1,5	2,5	2,5	2,5
Leiter mm² max	4	4	4	10	10	10

CEE-inbouwcontactdoos TE

- Schroefklemmen
- Flensafmeting 114x114mm
- Hoek 15°
- Hittebestendige contactdragers
- KONTEX contact en raamklemmen
- Vernikkelde contacten
- Beschermingsklasse IP67
- Bij wandcontactdozen met Pilot graag een -P toevoegen aan het artikelnummer



12160

Ampere	Polen	110V 50-60 Hz			230V 50-60 Hz			400V 50-60 Hz			500V 50-60 Hz			>50V 301-500Hz			>50V 100-300Hz			kg Gewicht
		3pol 4h	4pol 4h	5pol 4h	3pol 6h	4pol 9h	5pol 9h	3pol 9h	4pol 6h	5pol 6h	3pol 7h	4pol 7h	5pol 7h	3pol 2h	4pol 2h	5pol 2h	3pol 10h	4pol 10h	5pol 10h	
63	3	12409												0.510						
63	4	12410						12156						0.560						
63	5	12160												0.573						

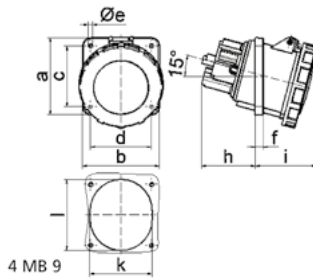

Ampere	63	63	63			
Polzahl	3	4	5			
a	114,0	114,0	114,0			
b	114,0	114,0	114,0			
c	90,0	90,0	90,0			
d	90,0	90,0	90,0			
e ø	6,5	6,5	6,5			
f	12,0	12,0	12,0			
h	65,0	65,0	65,0			
i	80,0	80,0	80,0			
k	92,0	92,0	92,0			
l	92,0	92,0	92,0			
Leiter mm² min	6	6	6			
Leiter mm² max	25	25	25			

2

STEKERS, KOPPELINGEN EN TOESTELCONTACTDOZEN



CEE-stekers



CEE-toestelcontactdozen



CEE-fasenwisselaars



CEE-koppelingen





CEE-stekers en -koppelingen met MULTI GRIP

- wartelsysteem met geïntegreerde trekontlasting
- de rubberen afdichting zit vast en kan niet verloren gaan
- MULTI-GRIP wartels bereiken minstens beschermingsklasse IP67
- aanpassing aan alle kabeldoorsneden
- een statuscontrole van buitenaf is op elk moment mogelijk



CEE-stekers en -koppelingen met QUICK CONNECT 16A en 32A

- gepatenteerde, schroefloze snelkoppelingstechnologie, gebaseerd op het bekende kooiklemprincipe, met volledig open aansluitkamer
- tijdsbesparing tot 75%
- snelle, veilige en gecontroleerde aansluiting van aders
- de klem is geschikt voor alle soorten koperen aders
- QUICK-CONNECT is onderhoudsvrij, ongevoelig voor schokken, trillingen en temperatuurschommelingen



CEE-stekers en -koppelingen met QUICK CONNECT 63A

- het wereldwijd unieke schroefloze systeem voor 63A CEE-contactmaterialen
- alle voordelen zoals bij de 16A en 32A systemen
- schroefloze raamklemmen
- kabeldoorsneden voor flexibele aders van 6mm² - 16mm²
- kabeldoorsneden voor stijve en geslagen aders van 6mm² - 25mm²

Bruikbare aderconfiguraties

- flexibele aders
- flexibele aders met kabelschoen
- flexibele aders met adereindhul
- massieve aders

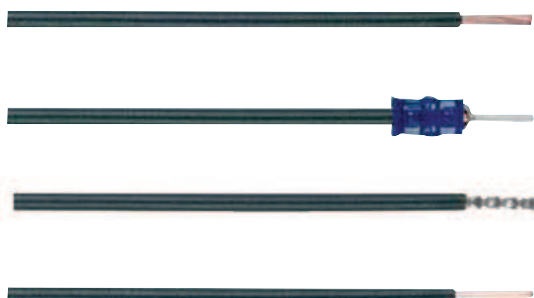

CEE-steker TE

- Schroefloze klemmen
- Vernikkelde contacten
- Hittebestendige contactdragers
- Speciale trekontlasting
- Behuizingsaansluiting met schroefdraad en kliksluiting
- Beschermingsklasse IP44

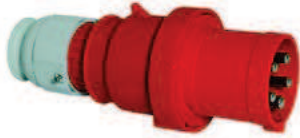

210765

Ampere	Polen	110V 50-60 Hz			230V 50-60 Hz			400V 50-60 Hz			500V 50-60 Hz			>50V 301-500Hz			>50V 100-300Hz			kg Gewicht
		3pol	4pol	5pol	3pol	4pol	5pol	3pol	4pol	5pol	3pol	4pol	5pol	3pol	4pol	5pol	3pol	4pol	5pol	
63	5	210765															0.720			

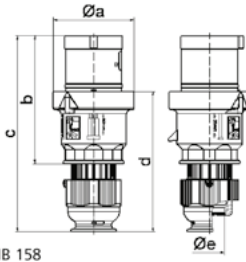

2 MB 158

Ampere	63	63	63			
Polzahl	3	4	5			
a ø	96,0	96,0	96,0			
b	153,0	153,0	153,0			
c	233,0	233,0	233,0			
d	167,0	167,0	167,0			
e ø	36,0	36,0	36,0			
Leiter mm² min	6	6	6			
Leiter mm² max	16	16	16			

CEE-steker TE

- Schroefklemmen
- Vernikkelde contacten
- Hittebestendige contactdragers
- Speciale trekontlasting
- Behuizingsaansluiting met schroefdraad en kliksluiting
- Beschermingsklasse IP44



2155

Ampere	Polen	110V 50-60 Hz			230V 50-60 Hz			400V 50-60 Hz			500V 50-60 Hz			>50V 301-500Hz			>50V 100-300Hz			kg Gewicht
		3pol	4pol	5pol	3pol	4pol	5pol	3pol	4pol	5pol	3pol	4pol	5pol	3pol	4pol	5pol				
63	3	21024	2104	21025	210030	21624											0.610			
63	4	2149	2150	2151	2152								21300				0.600			
63	5	2153	2154	2155	21167	21419	21663										0.665			

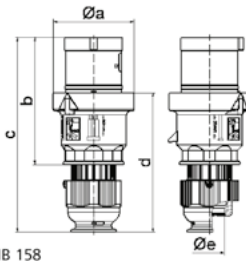

2 MB 158

Ampere	63	63	63			
Polzahl	3	4	5			
a ø	96,0	96,0	96,0			
b	153,0	153,0	153,0			
c	233,0	233,0	233,0			
d	167,0	167,0	167,0			
e ø	36,0	36,0	36,0			
Leiter mm² min	6	6	6			
Leiter mm² max	16	16	16			

CEE-steker

- Schroefklemmen
- Met korte kabeltule
- Beschermingsklasse IP44

231



Ampere	Polen	110V 50-60 Hz			230V 50-60 Hz			400V 50-60 Hz			500V 50-60 Hz			>50V 301-500Hz			>50V 100-300Hz			kg Gewicht
		3pol	4pol	5pol	3pol	4pol	5pol	3pol	4pol	5pol	3pol	4pol	5pol	3pol	4pol	5pol				
16	3	231															0.125			
16	5	236															0.150			
32	5	2300																		

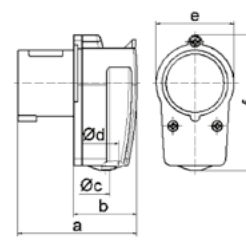

2 MB 12

Ampere	16	16	16	32		
Polzahl	3	4	5	5		
a	80,0	85,0	96,0	116,0		
b	44,0	49,0	59,0	70,0		
c ø	6,5	6,5	8,0	10,0		
d ø	18,0	18,0	18,0	25,0		
e	51,0	57,0	64,0	-		
f	90,0	95,0	74,0	101,0		
Leiter mm² min	1	1	1	2,5		
Leiter mm² max	2,5	2,5	2,5	6		

CEE-steker TE-Plus

- Schroefloze klemmen
- Hittebestendige contactdragers
- Vernikkelde contacten
- Speciale trekontlasting
- Beschermingsklasse IP67

MULTI GRIP
QUICK CONNECT



21241

	Ampere	Polen	110V	230V	400V	500V	>50V	>50V	kg
			50-60 Hz	50-60 Hz	50-60 Hz	50-60 Hz	301-500Hz	100-300Hz	
16	3		21237	21238	21402	21487	21558	21453	0.150
16	4		21403	21250	21349	21350	21405	21404	0.175
16	5		21406	21407	21239	21754	21533	21564	0.215
32	3		21408	21240	21409	21486		21545	0.272
32	4		21410	21251	21351	21352	21412	21411	0.291
32	5		21413	21414	21241	21282	210234	21484	0.350

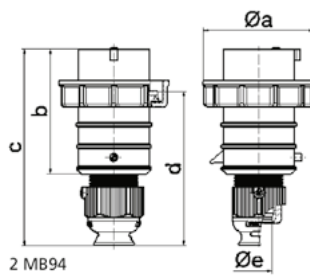

Ampere	16	16	16	32	32	32
Polzahl	3	4	5	3	4	5
a ø	70,0	78,0	86,0	94,0	94,0	101,0
b	95,0	95,0	97,0	118,0	118,0	117,0
c	145,0	145,0	152,0	178,0	178,0	181,0
d	111,0	111,0	119,0	136,0	136,0	138,5
e ø	18,0	18,0	21,0	23,0	23,0	27,0
Leiter mm² min	1	1	1	2,5	2,5	2,5
Leiter mm² max	2,5	2,5	2,5	6	6	6

CEE-steker

- Schroefklemmen
- Vernikkelde contacten
- 1-delige behuizing
- Speciale trekontlasting
- Beschermingsklasse IP67

MULTI GRIP

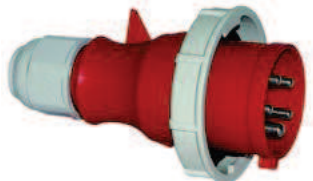

210607

	Ampere	Polen	110V	230V	400V	500V	>50V	>50V	kg
			50-60 Hz	50-60 Hz	50-60 Hz	50-60 Hz	301-500Hz	100-300Hz	
16	5		210587						0.170
32	3		210593						0.233
32	4		210599	210600					0.245
32	5		210605	210606					0.283

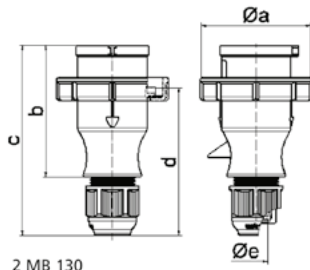

Ampere	16	16	16	32	32	32
Polzahl	3	4	5	3	4	5
a ø	70,0	78,0	86,0	94,0	94,0	101,0
b	94,5	98,0	101,0	115,0	115,0	119,0
c	138,0	142,0	145,0	170,0	170,0	174,0
d	105,5	109,5	112,5	128,0	128,0	132,0
e ø	18,0	18,0	18,0	23,0	23,0	23,0
Leiter mm² min	1	1	1	2,5	2,5	2,5
Leiter mm² max	2,5	2,5	2,5	6	6	6

CEE-steker TE-Plus

- Hittebestendige contactdragers
- Vernikkelde contacten
- Speciale trekontlasting
- Behuizingsaansluiting met schroefdraad en kliksluiting
- Beschermingsklasse IP67

QUICK CONNECT
MULTI GRIP



210766

	Ampere	Polen	110V	230V	400V	500V	>50V	>50V	kg
			50-60 Hz	50-60 Hz	50-60 Hz	50-60 Hz	301-500Hz	100-300Hz	
63	4				210762				0.720
63	5				210766				0.770

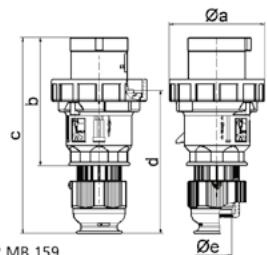

Ampere	63	63	63
Polzahl	3	4	5
a ø	113,5	113,5	113,5
b	153,0	153,0	153,0
c	233,0	233,0	233,0
d	171,0	171,0	171,0
e ø	36,0	36,0	36,0
Leiter mm² min	6	6	6
Leiter mm² max	16	16	16

CEE-steker TE-Plus

- Hittebestendige contactdragers
- Vernikkelde contacten
- Speciale trekontlasting
- Behuizingsaansluiting met schroefdraad en kliksluiting
- Beschermingsklasse IP67

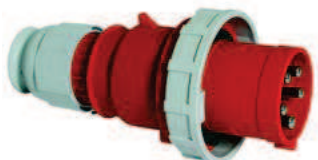

2189

Ampere	Polen	110V 50-60 Hz	230V 50-60 Hz	400V 50-60 Hz	500V 50-60 Hz	>50V 301-500Hz	>50V 100-300Hz	kg Gewicht
		3pol 4pol 5pol 4h 4h 4h	3pol 4pol 5pol 6h 9h 9h	3pol 4pol 5pol 9h 6h 6h	3pol 4pol 5pol 7h 7h 7h	3pol 4pol 5pol 2h 2h 2h	3pol 4pol 5pol 10h 10h 10h	
63	3	2180	2181	2182	21330			0.610
63	4	2183	2184	2185	2186	21154		0.655
63	5	2187	2188	2189	21060	21163	21645	0.705

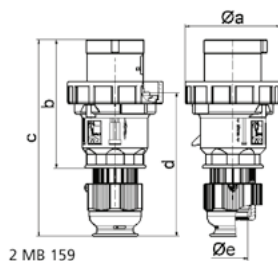

Ampere	63	63	63
Polzahl	3	4	5
a o	113,5	113,5	113,5
b	153,0	153,0	153,0
c	233,0	233,0	233,0
d	171,0	171,0	171,0
e o	36,0	36,0	36,0
Leiter mm² min	6	6	6
Leiter mm² max	16	16	16

CEE-steker TE

- Schroefklemmen
- Raamklemmen
- Hittebestendige contactdragers
- Vernikkelde contacten
- Speciale trekontlasting
- Behuizingsaansluiting met schroefdraad en kliksluiting
- Beschermingsklasse IP67



2199

Ampere	Polen	110V 50-60 Hz	230V 50-60 Hz	400V 50-60 Hz	500V 50-60 Hz	>50V 301-500Hz	>50V 100-300Hz	kg Gewicht
		3pol 4pol 5pol 4h 4h 4h	3pol 4pol 5pol 6h 9h 9h	3pol 4pol 5pol 9h 6h 6h	3pol 4pol 5pol 7h 7h 7h	3pol 4pol 5pol 2h 2h 2h	3pol 4pol 5pol 10h 10h 10h	
125	3	2190	2191	2192				1.020
125	4	2193	2194	2195	2196	21155	21607	1.125
125	5	2197	2198	2199	21555	21156		1.235

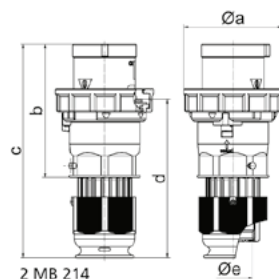

Ampere	125	125	125
Polzahl	3	4	5
a o	126,0	126,0	126,0
b	181,0	181,0	181,0
c	282,0	282,0	282,0
d	206,0	206,0	206,0
e o	50,0	50,0	50,0
Leiter mm² min	16	16	16
Leiter mm² max	50	50	50

CEE-toestelcontactdoos TE, opbouw

- Schroefloze klemmen
- Hittebestendige contactdragers+C105
- Vernikkelde contacten
- Vernikkelde contacten
- Kabelinvoer één keer boven (open), één keer onder en twee keer onder (gesloten)
- Behuizing 180° draaibaar
- 4 bevestigingsgaten in bodem behuizing
- Geschikt voor doorlussen
- Beschermingsklasse IP44

QUICK CONNECT



24413

		110V 50-60 Hz	230V 50-60 Hz	400V 50-60 Hz	500V 50-60 Hz	>50V 301-500Hz	>50V 100-300Hz	kg
		3pol 4pol 5pol 4h 4h 4h	3pol 4pol 5pol 6h 9h 9h	3pol 4pol 5pol 9h 6h 6h	3pol 4pol 5pol 7h 7h 7h	3pol 4pol 5pol 2h 2h 2h	3pol 4pol 5pol 10h 10h 10h	Gewicht
16	5	24362						0.303
32	3	24408	24409					0.316
32	4		24410	24411	24412			0.380
32	5	24413						0.364

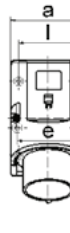

5 MB 45

Ampere Polzahl	16 5	32 3	32 4	32 5
a	83,0	83,0	83,0	83,0
b	126,0	126,0	126,0	126,0
c	155,5	165,0	165,0	166,0
d	122,0	128,0	128,0	130,0
e	68,0	68,0	68,0	68,0
f	11,0	11,0	11,0	11,0
h ø	5,5	5,5	5,5	5,5
i	6,5	6,5	6,5	6,5
k ø	12,0	12,0	12,0	12,0
l	65,0	65,0	65,0	65,0
m	80,0	80,0	80,0	80,0
n ø	10	10,0	10,0	10,0
p	M25	M25	M25	M25
f	2xM25	2xM25	2xM25	2xM25
Leiter mm² min	1	2,5	2,5	2,5
Leiter mm² max	2,5	6	6	6

CEE-toestelcontactdoos opbouw

- Schroefklemmen
- Kabelinvoer één keer boven (open), één keer onder (gesloten)
- Behuizingsbodem 180 gr draaibaar
- Beschermingsklasse IP44



24134

		110V 50-60 Hz	230V 50-60 Hz	400V 50-60 Hz	500V 50-60 Hz	>50V 301-500Hz	>50V 100-300Hz	kg
		3pol 4pol 5pol 4h 4h 4h	3pol 4pol 5pol 6h 9h 9h	3pol 4pol 5pol 9h 6h 6h	3pol 4pol 5pol 7h 7h 7h	3pol 4pol 5pol 2h 2h 2h	3pol 4pol 5pol 10h 10h 10h	Gewicht
63	3	24336						0.775
63	4	24337	24338	24339				0.925
63	5	24134						0.975



5 MB 48

Ampere Polzahl	63 3	63 4	63 5
a	118,0	118,0	118,0
b	170,0	170,0	170,0
c	259,0	259,0	259,0
d	174,0	174,0	174,0
e	104,0	104,0	104,0
f	136,0	136,0	136,0
h ø	6,1	6,1	6,1
i	6,0	6,0	6,0
k	M40	M40	M40
l	M32/32	M32/32	M32/32
Leiter mm² min	6	6	6
Leiter mm² max	16	16	16

CEE-toestelcontactdoos opbouw

- Schroefklemmen
- Met klapdeksel
- Beschermingsklasse IP44



242

		110V 50-60 Hz	230V 50-60 Hz	400V 50-60 Hz	500V 50-60 Hz	>50V 301-500Hz	>50V 100-300Hz	kg
		3pol 4pol 5pol 4h 4h 4h	3pol 4pol 5pol 6h 9h 9h	3pol 4pol 5pol 9h 6h 6h	3pol 4pol 5pol 7h 7h 7h	3pol 4pol 5pol 2h 2h 2h	3pol 4pol 5pol 10h 10h 10h	Gewicht
16	3	242						0.148

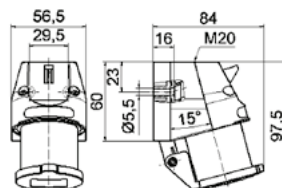

5 MB 161

CEE-toestelcontactdoos opbouw

- Schroefklemmen
- Met afdekdop
- Beschermingsklasse IP44

2P+E Ampere	3P+E Polen	110V 50-60 Hz	230V 50-60 Hz	400V 50-60 Hz	500V 50-60 Hz	>50V 301-500Hz	>50V 100-300Hz	kg
16	3	3pol 4h 4h 4h	3pol 4pol 5pol 6h 9h 9h	3pol 4pol 5pol 9h 6h 6h	3pol 4pol 5pol 7h 7h 7h	3pol 4pol 5pol 2h 2h 2h	3pol 4pol 5pol 10h 10h 10h	0.118



2400

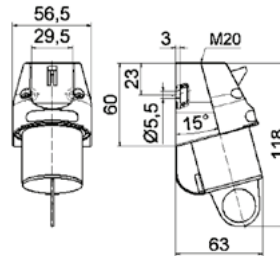

5 MB 162

CEE-toestelcontactdoos opbouw

- Schroefklemmen
- Met klapdeksel
- Beschermingsklasse IP44

2P+E Ampere	3P+E Polen	110V 50-60 Hz	230V 50-60 Hz	400V 50-60 Hz	500V 50-60 Hz	>50V 301-500Hz	>50V 100-300Hz	kg
16	5		2470	2471				0.271
32	3	24335	24017					0.310
32	4			24018	24019			0.329
32	5			24012				0.347



24012

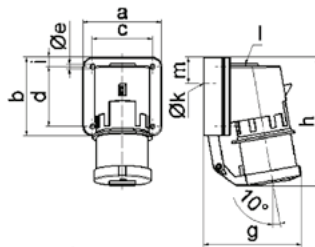

5 MB 12

Ampere	16	32	32	32
Polzahl	5	3	4	5
a	84,0	90,0	90,0	90,0
b	84,0	75,0	75,0	75,0
c	64,0	78,0	78,0	78,0
d	64,0	45,0	45,0	45,0
e ø	5,5	5,5	5,5	5,5
g	105,0	114,0	114,0	115,0
h	138,0	149,0	149,0	150,0
i	10,0	13,0	13,0	13,0
k ø	23,0	29,0	29,0	29,0
l	M20	M25	M25	M25
m	28,0	27,0	27,0	27,0
Leiter mm² min	1	2,5	2,5	2,5
Leiter mm² max	2,5	6	6	6

CEE-toestelcontactdoos opbouw

- Schroefklemmen
- Vernikkelde contacten
- Klem voor aders 1 t/m 2.5 qmm bij 16A en 2,5 t/m 6 qmm bij 32A
- Beschermingsklasse IP67

		110V 50-60 Hz			230V 50-60 Hz			400V 50-60 Hz			500V 50-60 Hz			>50V 301-500Hz			>50V 100-300Hz			kg Gewicht
		3pol	4pol	5pol	3pol	4pol	5pol	3pol	4pol	5pol	3pol	4pol	5pol	3pol	4pol	5pol	3pol	4pol	5pol	
16	3	2472			2473															0.205
16	4	2476			2477			2478												0.245
16	5							2483												0.261
32	3	24154			24020															0.305
32	4	24101			24021			24022												0.325
32	5							2402												0.337



2483

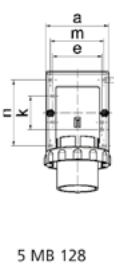

5 MB 128

Ampere Polzahl	16 3	16 4	16 5	32 3	32 4	32 5
a	64,0	75,0	84,0	90,0	90,0	90,0
b	87,0	100,0	84,0	75,0	75,0	75,0
c	137,0	151,0	136,0	138,0	138,0	139,0
d	112,0	119,0	-	122,0	122,0	123,0
e	51,0	59,0	-	-	-	-
f	-	11,0	-	-	-	-
h o	4,1	5,1	-	-	-	-
i	4,5	4,5	-	-	-	-
k	40,0	-	-	-	-	-
l	-	-	111,0	-	-	-
m	-	-	64,0	78,0	78,0	78,0
n	-	-	64,0	45,0	45,0	45,0
o o	-	-	5,5	5,5	5,5	5,5
p	M20	M20	-	-	-	-
r	-	-	M20	M25	M25	M25
s o	-	-	23,0	29,0	29,0	29,0
t	-	-	für M20	für M20	-	-

CEE-toestelcontactdoos opbouw

- Schroefklemmen
- Met afdekdop
- Vernikkelde contacten
- Klem voor aders 1 t/m 2.5 qmm bij 16A en 2,5 t/m 6 qmm bij 32A
- Beschermingsklasse IP67

		110V 50-60 Hz			230V 50-60 Hz			400V 50-60 Hz			500V 50-60 Hz			>50V 301-500Hz			>50V 100-300Hz			kg Gewicht
		3pol	4pol	5pol	3pol	4pol	5pol	3pol	4pol	5pol	3pol	4pol	5pol	3pol	4pol	5pol	3pol	4pol	5pol	
16	3	2484			2485			2486												0.260
16	4	2487			2488			2489			2490			2492			2491			0.288
16	5	2493			2494			2495												0.313
32	3	24216			24023															0.368
32	4							24024			24025									0.388
32	5							24013			24089									0.408



2495

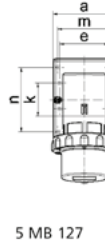

5 MB 127

Ampere Polzahl	16 3	16 4	16 5	32 3	32 4	32 5
a	64,0	75,0	84,0	90,0	90,0	90,0
b	87,0	100,0	84,0	75,0	75,0	75,0
c	137,0	151,0	137,0	147,0	147,0	148,0
d	112,0	119,0	-	122,0	122,0	123,0
e	51,0	59,0	-	-	-	-
f	-	11,0	-	-	-	-
h o	4,1	5,1	-	-	-	-
i	4,5	4,5	-	-	-	-
k	40,0	-	-	-	-	-
l	-	-	111,0	-	-	-
m	-	-	64,0	78,0	78,0	78,0
n	-	-	64,0	45,0	45,0	45,0
o o	-	-	5,5	5,5	5,5	5,5
p	M20	M20	-	-	-	-
r	-	-	M20	M25	M25	M25
s o	-	-	23,0	29,0	29,0	29,0
t	-	-	für M20	für M20	-	-

CEE-toestelcontactdoos opbouw

- Schroefloze klemmen
- Vernikkelde contacten
- Klem voor aders 1 t/m 2.5 qmm bij 16A en 2,5 t/m 6 qmm bij 32A
- Beschermingsklasse IP67

		110V 50-60 Hz			230V 50-60 Hz			400V 50-60 Hz			500V 50-60 Hz			>50V 301-500Hz			>50V 100-300Hz			kg Gewicht
		3pol	4pol	5pol	3pol	4pol	5pol	3pol	4pol	5pol	3pol	4pol	5pol	3pol	4pol	5pol	3pol	4pol	5pol	
16	5							24416												0.270
32	5							24418												0.339

QUICK CONNECT



24418

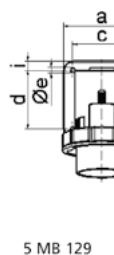

5 MB 129

Ampere Polzahl	16 5	32 5
a	84,0	90,0
b	84,0	75,0
c	64,0	78,0
d	64,0	45,0
e o	5,5	5,5
f	28,0	28,0
g	111,0	123,0
h	136,0	139,0
i	10,0	13,0
k o	23,0	29,0
l	M20	M25

CEE-toestelcontactdoos opbouw

- Schroefloze klemmen
- Met afdekdop
- Vernikkelde contacten
- Klem voor aders 1 t/m 2.5 qmm bij 16A en 2,5 t/m 6 qmm bij 32A
- Beschermingsklasse IP67

QUICK CONNECT



24419

		110V 50-60 Hz	230V 50-60 Hz	400V 50-60 Hz	500V 50-60 Hz	>50V 301-500Hz	>50V 100-300Hz	kg
		3pol 4pol 5pol 4h 4h 4h	3pol 4pol 5pol 6h 9h 9h	3pol 4pol 5pol 9h 6h 6h	3pol 4pol 5pol 7h 7h 7h	3pol 4pol 5pol 2h 2h 2h	3pol 4pol 5pol 10h 10h 10h	Gewicht
16	5	24258						0.321
32	5	24419						0.407

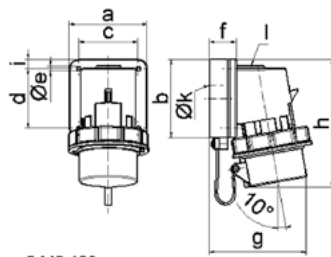

5 MB 130

Ampere	16	32			
Polzahl	5	5			
a	84,0	90,0			
b	84,0	75,0			
c	64,0	78,0			
d	64,0	45,0			
e	5,5	5,5			
f	28,0	28,0			
g	111,0	123,0			
h	137,0	148,0			
i	10,0	13,0			
k	23,0	29,0			
l	M20	M25			

CEE-toestelcontactdoos opbouw

- Schroefklemmen
- Raamklemmen
- Kabelinvoer één keer boven (open), 2 maal onder (gesloten)
- Behuizing 180° draaibaar
- Vernikkelde contacten
- Beschermingsklasse IP67



24062

		110V 50-60 Hz	230V 50-60 Hz	400V 50-60 Hz	500V 50-60 Hz	>50V 301-500Hz	>50V 100-300Hz	kg
		3pol 4pol 5pol 4h 4h 4h	3pol 4pol 5pol 6h 9h 9h	3pol 4pol 5pol 9h 6h 6h	3pol 4pol 5pol 7h 7h 7h	3pol 4pol 5pol 2h 2h 2h	3pol 4pol 5pol 10h 10h 10h	Gewicht
63	3	24140	24340					0.845
63	4	24232	24341	24035	24342			0.995
63	5			24062			24320	1.090

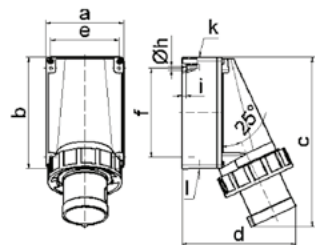

5 MB 37

Ampere	63	63	63		
Polzahl	3	4	5		
a	118,0	118,0	118,0		
b	170,0	170,0	170,0		
c	259,0	259,0	259,0		
d	174,0	174,0	174,0		
e	104,0	104,0	104,0		
f	136,0	136,0	136,0		
h	6,1	6,1	6,1		
i	6,0	6,0	6,0		
k	M40	M40	M40		
l	M32/32	M32/32	M32/32		
Leiter mm² min	6	6	6		
Leiter mm² max	16	16	16		

CEE-toestelcontactdoos opbouw

- Schroefklemmen
- Raamklemmen
- Hittebestendige contactdragers
- Vernikkelde contacten
- Beschermingsklasse IP67



24202

		110V 50-60 Hz	230V 50-60 Hz	400V 50-60 Hz	500V 50-60 Hz	>50V 301-500Hz	>50V 100-300Hz	kg
		3pol 4pol 5pol 4h 4h 4h	3pol 4pol 5pol 6h 9h 9h	3pol 4pol 5pol 9h 6h 6h	3pol 4pol 5pol 7h 7h 7h	3pol 4pol 5pol 2h 2h 2h	3pol 4pol 5pol 10h 10h 10h	Gewicht
125	3	24198						1.835
125	4	24200						2.138
125	5	24202						2.245

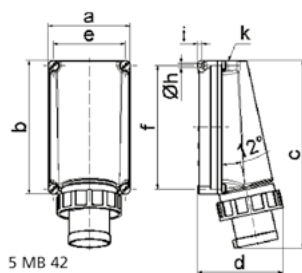

5 MB 42

Ampere	125	125	125		
Polzahl	3	4	5		
a	160,0	160,0	160,0		
b	260,0	260,0	260,0		
c	364,0	364,0	364,0		
d	165,0	165,0	165,0		
e	140,0	140,0	140,0		
f	240,0	240,0	240,0		
h	8,3	8,3	8,3		
i	10,0	10,0	10,0		
k	M50	M50	M50		
Leiter mm² min	16	16	16		
Leiter mm² max	50	50	50		

CEE-toestelcontactdoos TE, aanbouw

- Schroefloze klemmen
- Hittebestendige contactdragers
- Vernikkelde contacten
- Aan de achterkant geopend
- Beschermingsklasse IP44

QUICK CONNECT



26050

		110V 50-60 Hz	230V 50-60 Hz	400V 50-60 Hz	500V 50-60 Hz	>50V 301-500Hz	>50V 100-300Hz	kg
		3pol 4pol 5pol 4h 4h 4h	3pol 4pol 5pol 6h 9h 9h	3pol 4pol 5pol 9h 6h 6h	3pol 4pol 5pol 7h 7h 7h	3pol 4pol 5pol 2h 2h 2h	3pol 4pol 5pol 10h 10h 10h	Gewicht
16	5	26050						0.179
32	5	26051						0.242

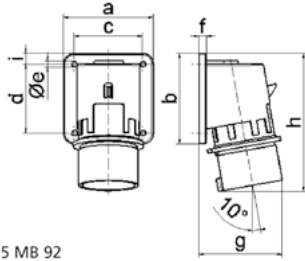

5 MB 92

Ampere Polzahl	16	32				
a	84,0	90,0				
b	84,0	75,0				
c	64,0	78,0				
d	64,0	45,0				
e ø	5,5	5,5				
f	7,0	7,0				
g	78,0	88,0				
h	129,0	139,0				
i	10,0	13,0				
Leiter mm² min	1	2,5				
Leiter mm² max	2,5	6				

CEE-toestelcontactdoos aanbouw

- Schroefklemmen
- Aan de achterkant open
- Beschermingsklasse IP44



2612

		110V 50-60 Hz	230V 50-60 Hz	400V 50-60 Hz	500V 50-60 Hz	>50V 301-500Hz	>50V 100-300Hz	kg
		3pol 4pol 5pol 4h 4h 4h	3pol 4pol 5pol 6h 9h 9h	3pol 4pol 5pol 9h 6h 6h	3pol 4pol 5pol 7h 7h 7h	3pol 4pol 5pol 2h 2h 2h	3pol 4pol 5pol 10h 10h 10h	Gewicht
16	3	260	261	262				0.141
16	4	263	264	265	266	268	267	0.156
16	5		2611	2612	2649	26036		0.179
32	3		2662					0.205
32	4		2684	2663	2664		2679	0.221
32	5		26030	2600		26029		0.240

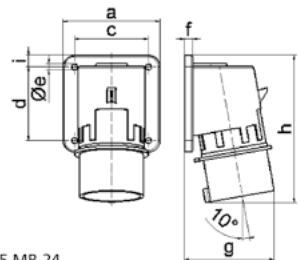

5 MB 24

Ampere Polzahl	16	16	16	32	32	32
	3	4	5	3	4	5
a	74,0	75,0	84,0	90,0	90,0	90,0
b	84,0	100,0	84,0	75,0	75,0	75,0
c	58,0	62,0	64,0	78,0	78,0	78,0
d	64,0	74,0	64,0	45,0	45,0	45,0
e ø	5,5	4,3	5,5	5,5	5,5	5,5
f	12,0	12,0	7,0	7,0	7,0	7,0
g	70,0	77,0	78,0	86,0	86,0	88,0
h	128,0	145,0	129,0	138,0	138,0	140,0
i	-	-	-	13,0	13,0	13,0
Leiter mm² min	1	1	1	2,5	2,5	2,5
Leiter mm² max	2,5	2,5	2,5	6	6	6

CEE-toestelcontactdoos aanbouw

- Schroefklemmen
- Met klapdeksel
- Aan de achterkant open
- Beschermingsklasse IP44



2655

		110V 50-60 Hz	230V 50-60 Hz	400V 50-60 Hz	500V 50-60 Hz	>50V 301-500Hz	>50V 100-300Hz	kg
		3pol 4pol 5pol 4h 4h 4h	3pol 4pol 5pol 6h 9h 9h	3pol 4pol 5pol 9h 6h 6h	3pol 4pol 5pol 7h 7h 7h	3pol 4pol 5pol 2h 2h 2h	3pol 4pol 5pol 10h 10h 10h	Gewicht
16	3	2625	2626	2627				0.163
16	4	2628	2629	2630	2631		2632	0.185
16	5		2635	2636	2671			0.263
32	3		2656					0.299
32	4		2685	2657	2658			0.316
32	5			2655				0.337

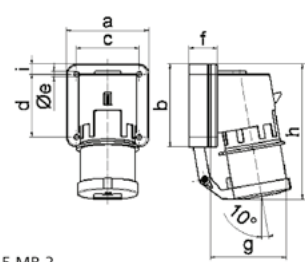

5 MB 2

Ampere Polzahl	16	16	16	32	32	32
	3	4	5	3	4	5
a	74,0	75,0	84,0	90,0	90,0	90,0
b	84,0	100,0	84,0	75,0	75,0	75,0
c	58,0	62,0	64,0	78,0	78,0	78,0
d	64,0	74,0	64,0	45,0	45,0	45,0
e ø	5,5	4,3	5,5	5,5	5,5	5,5
f	12,0	12,0	29,0	29,0	29,0	29,0
g	78,0	88,0	105,0	114,0	114,0	115,0
h	134,0	151,0	138,0	149,0	149,0	150,0
i	-	-	-	13,0	13,0	13,0
Leiter mm² min	1	1	1	2,5	2,5	2,5
Leiter mm² max	2,5	2,5	2,5	6	6	6

CEE-toestelcontactdoos TE, aanbouw

- Schroefloze klemmen
- Hoek 10°
- Hittebestendige contactdragers
- Vernikkelde contacten
- Aan de achterkant geopend
- Beschermingsklasse IP44

QUICK CONNECT



27124

Ampere	Polen	110V 50-60 Hz	230V 50-60 Hz	400V 50-60 Hz	500V 50-60 Hz	>50V 301-500Hz	>50V 100-300Hz	kg Gewicht
		3pol 4pol 5pol 4h 4h 4h	3pol 4pol 5pol 6h 9h 9h	3pol 4pol 5pol 9h 6h 6h	3pol 4pol 5pol 7h 7h 7h	3pol 4pol 5pol 2h 2h 2h	3pol 4pol 5pol 10h 10h 10h	
16	3	27209	27121					0.151
16	4			27122				0.176
16	5			27124				0.195
32	3		27219					0.214
32	4			27223				0.246
32	5		27248	27249				0.267

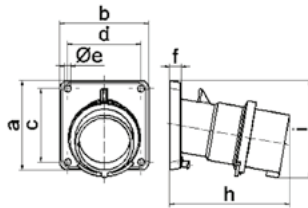

5 MB 21

Ampere Polzahl	16 3	16 4	16 5	32 3	32 4	32 5
a	85,0	85,0	85,0	85,0	85,0	85,0
b	85,0	85,0	85,0	85,0	85,0	85,0
c	70,0	70,0	70,0	70,0	70,0	70,0
d	70,0	70,0	70,0	70,0	70,0	70,0
e Ø	6,3	6,3	6,3	6,3	6,3	6,3
f	11,0	11,0	11,0	11,0	11,0	11,0
h	104,0	110,0	116,0	121,0	121,0	127,0
i	83,0	90,0	92,0	96,0	96,0	100,0
Leiter mm² min	1	1	1	2,5	2,5	2,5
Leiter mm² max	2,5	2,5	2,5	6	6	6

CEE-toestelcontactdoos TE, aanbouw

- Schroefklemmen
- Hoek 10°
- Raamklemmen
- Hittebestendige contactdragers
- Vernikkelde contacten
- Aan de achterkant geopend
- Beschermingsklasse IP44



2781

Ampere	Polen	110V 50-60 Hz	230V 50-60 Hz	400V 50-60 Hz	500V 50-60 Hz	>50V 301-500Hz	>50V 100-300Hz	kg Gewicht
		3pol 4pol 5pol 4h 4h 4h	3pol 4pol 5pol 6h 9h 9h	3pol 4pol 5pol 9h 6h 6h	3pol 4pol 5pol 7h 7h 7h	3pol 4pol 5pol 2h 2h 2h	3pol 4pol 5pol 10h 10h 10h	
63	3		2771					0.520
63	4		2774	2775	2776			0.600
63	5			2781				0.625

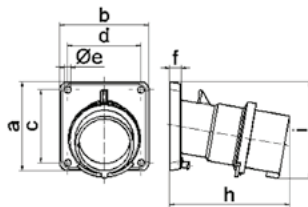

5 MB 21

Ampere Polzahl	16 3	16 4	16 5	32 3	32 4	32 5
a	85,0	85,0	85,0	85,0	85,0	85,0
b	85,0	85,0	85,0	85,0	85,0	85,0
c	70,0	70,0	70,0	70,0	70,0	70,0
d	70,0	70,0	70,0	70,0	70,0	70,0
e Ø	6,3	6,3	6,3	6,3	6,3	6,3
f	11,0	11,0	11,0	11,0	11,0	11,0
h	104,0	110,0	116,0	121,0	121,0	127,0
i	83,0	90,0	92,0	96,0	96,0	100,0
Leiter mm² min	1	1	1	2,5	2,5	2,5
Leiter mm² max	2,5	2,5	2,5	6	6	6

CEE-toestelcontactdoos TE, aanbouw

- Schroefloze klemmen
- Hittebestendige contactdragers
- Aan de achterkant open
- Vernikkelde contacten
- Beschermingsklasse IP67

QUICK CONNECT



26054

		110V 50-60 Hz	230V 50-60 Hz	400V 50-60 Hz	500V 50-60 Hz	>50V 301-500Hz	>50V 100-300Hz	kg
		3pol 4pol 5pol 4h 4h 4h	3pol 4pol 5pol 6h 9h 9h	3pol 4pol 5pol 9h 6h 6h	3pol 4pol 5pol 7h 7h 7h	3pol 4pol 5pol 2h 2h 2h	3pol 4pol 5pol 10h 10h 10h	Gewicht
16	5	26054						0.210
32	5	26055						0.295

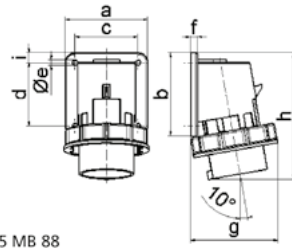

5 MB 88

Ampere Polzahl	16 5	32 5			
a	84,0	90,0			
b	84,0	75,0			
c	64,0	78,0			
d	64,0	45,0			
e ø	5,5	5,5			
f	7,0	7,0			
g	90,0	101,0			
h	129,0	139,0			
i	10,0	13,0			
Leiter mm² min	1	2,5			
Leiter mm² max	2,5	6			

CEE-toestelcontactdoos aanbouw

- Schroefloze klemmen
- Met afdekdop
- Hittebestendige contactdragers
- Vernikkelde contacten
- Aan de achterkant geopend
- Beschermingsklasse IP67

QUICK CONNECT



26056

		110V 50-60 Hz	230V 50-60 Hz	400V 50-60 Hz	500V 50-60 Hz	>50V 301-500Hz	>50V 100-300Hz	kg
		3pol 4pol 5pol 4h 4h 4h	3pol 4pol 5pol 6h 9h 9h	3pol 4pol 5pol 9h 6h 6h	3pol 4pol 5pol 7h 7h 7h	3pol 4pol 5pol 2h 2h 2h	3pol 4pol 5pol 10h 10h 10h	Gewicht
16	5	26056						0.313
32	5	26057						0.402

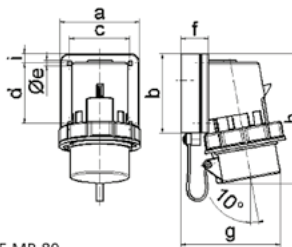

5 MB 89

Ampere Polzahl	16 5	32 5			
a	84,0	90,0			
b	84,0	75,0			
c	64,0	78,0			
d	64,0	45,0			
e ø	5,5	5,5			
f	28,0	28,0			
g	111,0	123,0			
h	137,0	148,0			
i	10,0	13,0			
Leiter mm² min	1	2,5			
Leiter mm² max	2,5	6			

CEE-toestelcontactdoos aanbouw

- Schroefklemmen
- Met afdekdop
- Vernikkelde contacten
- Aan de achterkant geopend
- Beschermingsklasse IP67

2604



		110V 50-60 Hz	230V 50-60 Hz	400V 50-60 Hz	500V 50-60 Hz	>50V 301-500Hz	>50V 100-300Hz	kg
		3pol 4pol 5pol 4h 4h 4h	3pol 4pol 5pol 6h 9h 9h	3pol 4pol 5pol 9h 6h 6h	3pol 4pol 5pol 7h 7h 7h	3pol 4pol 5pol 2h 2h 2h	3pol 4pol 5pol 10h 10h 10h	Gewicht
16	3	2637	2638	2639				0.196
16	4		2641	2642	2643			0.219
16	5		2647	2648				0.308
32	3		2659					0.370
32	4			2660	2661			0.387
32	5			2604				0.404

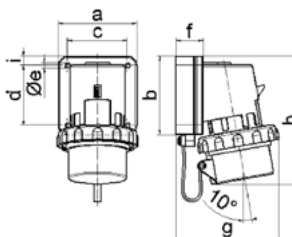

5 MB 3

Ampere Polzahl	16 3	16 4	16 5	32 3	32 4	32 5
a	74,0	75,0	84,0	90,0	90,0	90,0
b	84,0	100,0	84,0	75,0	75,0	75,0
c	58,0	62,0	64,0	78,0	78,0	78,0
d	64,0	74,0	64,0	45,0	45,0	45,0
e ø	5,5	4,3	5,5	5,5	5,5	5,5
f	12,0	12,0	29,0	29,0	29,0	29,0
g	80,0	88,0	111,0	123,0	123,0	123,0
h	133,0	152,0	134,0	147,0	147,0	148,0
i	-	-	10,0	13,0	13,0	13,0
Leiter mm² min	1	1	1	2,5	2,5	2,5
Leiter mm² max	2,5	2,5	2,5	6	6	6

CEE-toestelcontactdoos TE, aanbouw

- Schroefloze klemmen
- Hoek 10°
- Hittebestendige contactdragers
- Vernikkelde contacten
- Aan de achterkant geopend
- Beschermingsklasse IP67

QUICK CONNECT



2793

	Ampere	Polen	110V	230V	400V	500V	>50V	>50V	kg
			50-60 Hz	50-60 Hz	50-60 Hz	50-60 Hz	301-500Hz	100-300Hz	
16	3		27227	2783					0.175
16	4			2786	2787	27230			0.200
16	5		27233		2793				0.227
32	3		27235	27236					0.260
32	4			27239	27240	27241			0.279
32	5		27244	27245	27246				0.317

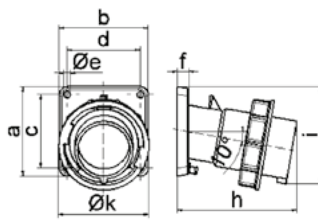

5 MB 22

Ampere	16	16	16	32	32	32
Polzahl	3	4	5	3	4	5
a	85,0	85,0	85,0	85,0	85,0	85,0
b	85,0	85,0	85,0	85,0	85,0	85,0
c	70,0	70,0	70,0	70,0	70,0	70,0
d	70,0	70,0	70,0	70,0	70,0	70,0
e ø	6,3	6,3	6,3	6,3	6,3	6,3
f	11,0	11,0	11,0	11,0	11,0	11,0
h	104,0	110,0	116,0	121,0	121,0	127,0
i	83,0	90,0	92,0	96,0	96,0	100,0
k	70,5	79,5	86,5	95,0	95,0	101,5
Leiter mm² min	1	1	1	2,5	2,5	2,5
Leiter mm² max	2,5	2,5	2,5	6	6	6

CEE-toestelcontactdoos TE, aanbouw

- Schroefklemmen
- Hoek 10°
- Raamklemmen
- Hittebestendige contactdragers
- Vernikkelde contacten
- Aan de achterkant geopend
- Beschermingsklasse IP67

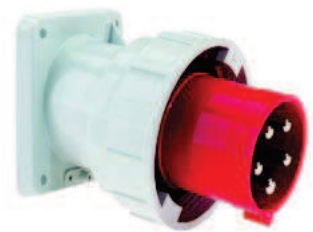

27017

	Ampere	Polen	110V	230V	400V	500V	>50V	>50V	kg
			50-60 Hz	50-60 Hz	50-60 Hz	50-60 Hz	301-500Hz	100-300Hz	
63	3		27006	27007					0.575
63	4			27010	27011	27012			0.685
63	5		27015	27016	27017				0.695

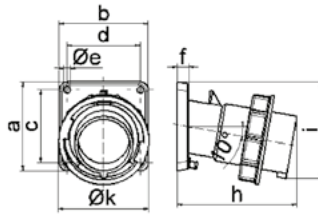

5 MB 22

Ampere	16	16	16	32	32	32
Polzahl	3	4	5	3	4	5
a	85,0	85,0	85,0	85,0	85,0	85,0
b	85,0	85,0	85,0	85,0	85,0	85,0
c	70,0	70,0	70,0	70,0	70,0	70,0
d	70,0	70,0	70,0	70,0	70,0	70,0
e ø	6,3	6,3	6,3	6,3	6,3	6,3
f	11,0	11,0	11,0	11,0	11,0	11,0
h	104,0	110,0	116,0	121,0	121,0	127,0
i	83,0	90,0	92,0	96,0	96,0	100,0
k	70,5	79,5	86,5	95,0	95,0	101,5
Leiter mm² min	1	1	1	2,5	2,5	2,5
Leiter mm² max	2,5	2,5	2,5	6	6	6

CEE-toestelcontactdoos TE, aanbouw

- Schroefklemmen
- Hoek 10°
- Raamklemmen
- Hittebestendige contactdragers
- Vernikkelde contacten
- Aan de achterkant geopend
- Beschermingsklasse IP67



2744

	Ampere	Polen	110V	230V	400V	500V	>50V	>50V	kg
			50-60 Hz	50-60 Hz	50-60 Hz	50-60 Hz	301-500Hz	100-300Hz	
125	3			2736					0.905
125	4		2738	2739	2740	2741			1.005
125	5			2743	2744	27024			1.135

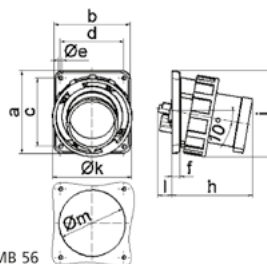

5 MB 56

Ampere	125	125	125
Polzahl	3	4	5
a	130,0	130,0	130,0
b	120,0	120,0	120,0
c	108,0	108,0	108,0
d	100,0	100,0	100,0
e ø	6,5	6,5	6,5
f	13,0	13,0	13,0
h	130,0	130,0	130,0
i	135,0	135,0	135,0
k	126,0	126,0	126,0
l	23,0	23,0	23,0
m ø	105,0	105,0	105,0
Leiter mm² min	16	16	16
Leiter mm² max	50	50	50

CEE-flenstoestelcontactdoos

- Schroefloze klemmen
- Flens 75x75 mm
- Beschermingsklasse IP44

QUICK CONNECT



282002

Ampere	Polen	110V 50-60 Hz	230V 50-60 Hz	400V 50-60 Hz	500V 50-60 Hz	>50V 301-500Hz	>50V 100-300Hz	kg Gewicht
		3pol 4pol 5pol 4h 4h 4h	3pol 4pol 5pol 6h 9h 9h	3pol 4pol 5pol 9h 6h 6h	3pol 4pol 5pol 7h 7h 7h	3pol 4pol 5pol 2h 2h 2h	3pol 4pol 5pol 10h 10h 10h	
16	3	28001	28111					0.090
16	4	28003	28017	28112	28004			0.103
16	5		28006	282001		28008		0.122
32	3	28009	28010					0.142
32	4		28011	28012	28013			0.152
32	5		28015	282002				0.192

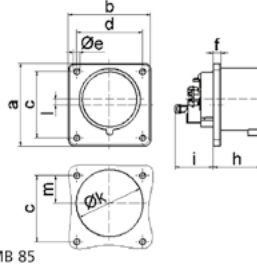

Ampere	16	16	16	32	32	32
Polzahl	3	4	5	3	4	5
a	75,0	75,0	75,0	75,0	75,0	75,0
b	75,0	75,0	75,0	75,0	75,0	75,0
c	60,0	60,0	60,0	60,0	60,0	60,0
d	60,0	60,0	60,0	60,0	60,0	60,0
e o	5,5	5,5	5,5	5,5	5,5	5,5
f	7,0	7,0	7,0	7,0	7,0	7,0
h	43,0	43,0	43,0	53,0	53,0	53,0
i	39,0	39,0	39,0	43,0	43,0	43,0
k o	42,0	48,0	61,0	57,0	57,0	60,0
l	-	-	5,0	2,0	2,0	-
m	30,0	30,0	25,0	28,0	28,0	30,0
Leiter mm² min	1	1	1	2,5	2,5	2,5
Leiter mm² max	2,5	2,5	2,5	6	6	6

CEE-flenstoestelcontactdoos

- Schroefklemmen
- Beschermingsklasse IP44



28108

Ampere	Polen	110V 50-60 Hz	230V 50-60 Hz	400V 50-60 Hz	500V 50-60 Hz	>50V 301-500Hz	>50V 100-300Hz	kg Gewicht	
		3pol 4pol 5pol 4h 4h 4h	3pol 4pol 5pol 6h 9h 9h	3pol 4pol 5pol 9h 6h 6h	3pol 4pol 5pol 7h 7h 7h	3pol 4pol 5pol 2h 2h 2h	3pol 4pol 5pol 10h 10h 10h		
16	3	2898							0.153
16	5	28102							0.183
32	3	28104							0.199
32	4	28106							0.215
32	5	28108							0.240

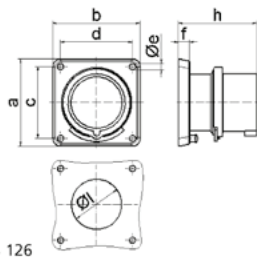

Ampere	16	16	16	32	32	32
Polzahl	3	4	5	3	4	5
a	85,0	85,0	85,0	85,0	85,0	85,0
b	85,0	85,0	85,0	85,0	85,0	85,0
c	70,0	70,0	70,0	70,0	70,0	70,0
d	70,0	70,0	70,0	70,0	70,0	70,0
e o	6,3	6,3	6,3	6,3	6,3	6,3
f	11,0	11,0	11,0	11,0	11,0	11,0
h	75,5	75,0	76,5	85,0	85,0	85,0
l o	49,0	49,0	49,0	49,0	49,0	49,0
Leiter mm² min	1	1	1	2,5	2,5	2,5
Leiter mm² max	2,5	2,5	2,5	6	6	6

CEE-flenstoestelcontactdoos TE

- Schroefklemmen
- Hittebestendige contactdragers
- Vernikkelde contacten
- Beschermingsklasse IP67

Ampere	Polen	110V 50-60 Hz			230V 50-60 Hz			400V 50-60 Hz			500V 50-60 Hz			>50V 301-500Hz			>50V 100-300Hz			kg Gewicht
		3pol	4pol	5pol	3pol	4pol	5pol	3pol	4pol	5pol	3pol	4pol	5pol	3pol	4pol	5pol	3pol	4pol	5pol	
16	3	2899															0.179			
16	4				28101												0.199			
16	5							28103									0.219			
32	3	28105															0.250			
32	4				28107												0.267			
32	5							28109									0.297			



28109

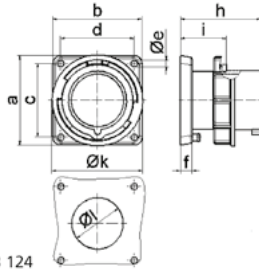

5 MB 124

Ampere	16	16	16	32	32	32
Polzahl	3	4	5	3	4	5
a	85,0	85,0	85,0	85,0	85,0	85,0
b	85,0	85,0	85,0	85,0	85,0	85,0
c	70,0	70,0	70,0	70,0	70,0	70,0
d	70,0	70,0	70,0	70,0	70,0	70,0
e ø	6,3	6,3	6,3	6,3	6,3	6,3
f	11,0	11,0	11,0	11,0	11,0	11,0
h	75,5	75,0	76,5	85,0	85,0	85,0
i	44,0	44,0	44,0	44,0	44,0	44,0
k	70,5	78,5	86,5	94,0	94,0	101,5
l ø	49,0	49,0	49,0	49,0	49,0	49,0
Leiter mm² min	1	1	1	2,5	2,5	2,5
Leiter mm² max	2,5	2,5	2,5	6	6	6

CEE-flenstoestelcontactdoos TE

- Schroefklemmen
- Raamklemmen
- Hittebestendige contactdragers
- Vernikkelde contacten
- Beschermingsklasse IP67

Ampere	Polen	110V 50-60 Hz			230V 50-60 Hz			400V 50-60 Hz			500V 50-60 Hz			>50V 301-500Hz			>50V 100-300Hz			kg Gewicht
		3pol	4pol	5pol	3pol	4pol	5pol	3pol	4pol	5pol	3pol	4pol	5pol	3pol	4pol	5pol	3pol	4pol	5pol	
63	3	2881									2835						0.529			
63	4				2842						2836						0.580			
63	5							2838									0.650			



2838

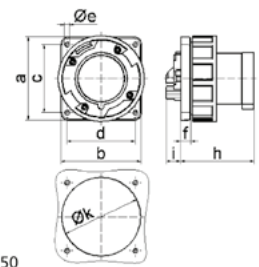

5 MB 50

Ampere	63	63	63
Polzahl	3	4	5
a	110,0	110,0	110,0
b	106,0	106,0	106,0
c	90,0	90,0	90,0
d	90,0	90,0	90,0
e ø	5,5	5,5	5,5
f	13,0	13,0	13,0
h	96,0	96,0	96,0
i	19,0	19,0	19,0
k	93,0	93,0	93,0
Leiter mm² min	6	6	6
Leiter mm² max	16	16	16

CEE-flenstoestelcontactdoos TE

- Schroefklemmen
- Flens 120x120 mm
- Raamklemmen
- Hittebestendige contactdragers
- Vernikkelde contacten
- Beschermingsklasse IP67

Ampere	Polen	110V 50-60 Hz			230V 50-60 Hz			400V 50-60 Hz			500V 50-60 Hz			>50V 301-500Hz			>50V 100-300Hz			kg Gewicht
		3pol	4pol	5pol	3pol	4pol	5pol	3pol	4pol	5pol	3pol	4pol	5pol	3pol	4pol	5pol	3pol	4pol	5pol	
125	3	2860															0.885			
125	4				2861												0.950			
125	5							2876									1.110			



2876

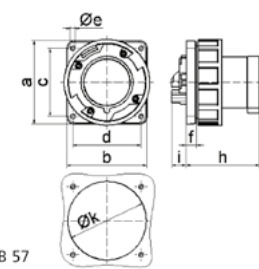

5 MB 57

Ampere	125	125	125
Polzahl	3	4	5
a	120,0	120,0	120,0
b	120,0	120,0	120,0
c	100,0	100,0	100,0
d	100,0	100,0	100,0
e ø	6,5	6,5	6,5
f	13,0	13,0	13,0
h	116,0	116,0	116,0
i	20,0	20,0	20,0
k	104,0	104,0	104,0
Leiter mm² min	16	16	16
Leiter mm² max	50	50	50

Fasenwisselaars als steker

- Schroefloze klemmen
- Behuizing met schroefdraad en kliksluiting
- Speciale trekontlasting
- Vernikkelde contacten
- Beschermingsklasse IP44

MULTI GRIP
QUICK CONNECT



2225

	110V 50-60 Hz	230V 50-60 Hz	400V 50-60 Hz	500V 50-60 Hz	>50V 301-500Hz	>50V 100-300Hz	kg
	3pol 4pol 5pol 4h 4h 4h	3pol 4pol 5pol 6h 9h 9h	3pol 4pol 5pol 9h 6h 6h	3pol 4pol 5pol 7h 7h 7h	3pol 4pol 5pol 2h 2h 2h	3pol 4pol 5pol 10h 10h 10h	Gewicht
16 4		22052	22053				0.150
16 5		224	225				0.160
32 4		22054	22055				0.240
32 5			227				0.294

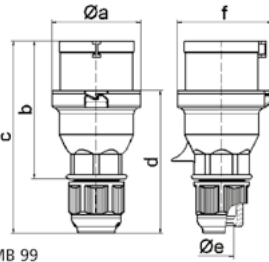

Ampere	16	16	16	32	32	32
Polzahl	3	4	5	3	4	5
a ø	53,0	60,0	66,0	74,5	74,5	74,5
b	93,5	100,5	103,0	121,0	121,0	121,5
c	134,0	141,0	142,0	174,0	174,0	174,5
d	97,5	104,5	105,5	128,0	128,0	128,5
e ø	18,0	18,0	18,0	23,0	23,0	23,0
f	57,5	64,5	70,5	78,0	78,0	80,0
Leiter mm² min	1	1	1	2,5	2,5	2,5
Leiter mm² max	2,5	2,5	2,5	6	6	6

Fasenwisselaars als steker TE

- Schroefklemmen
- Speciale trekontlasting
- Hittebestendige contactdragers
- Vernikkelde contacten
- Beschermingsklasse IP44

MULTI GRIP



2271

	110V 50-60 Hz	230V 50-60 Hz	400V 50-60 Hz	500V 50-60 Hz	>50V 301-500Hz	>50V 100-300Hz	kg
	3pol 4pol 5pol 4h 4h 4h	3pol 4pol 5pol 6h 9h 9h	3pol 4pol 5pol 9h 6h 6h	3pol 4pol 5pol 7h 7h 7h	3pol 4pol 5pol 2h 2h 2h	3pol 4pol 5pol 10h 10h 10h	Gewicht
16 5		2286	2271				0.194
32 5		2287	2288				0.299

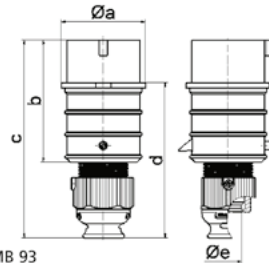

Ampere	16	16	16	32	32	32
Polzahl	3	4	5	3	4	5
a ø	51,0	57,5	65,0	66,0	66,0	72,0
b	95,0	95,0	97,0	118,0	118,0	117,0
c	145,0	145,0	152,0	178,0	178,0	181,0
d	109,0	109,0	116,0	133,0	133,0	135,5
e ø	18,0	18,0	21,0	23,0	23,0	27,0
Leiter mm² min	1	1	1	2,5	2,5	2,5
Leiter mm² max	2,5	2,5	2,5	6	6	6

Fasenwisselaars als WCD

- Schroefklemmen
- Hittebestendige contactdragers
- Vernikkelde contacten
- Beschermingsklasse IP44

24211



	110V 50-60 Hz	230V 50-60 Hz	400V 50-60 Hz	500V 50-60 Hz	>50V 301-500Hz	>50V 100-300Hz	kg
	3pol 4pol 5pol 4h 4h 4h	3pol 4pol 5pol 6h 9h 9h	3pol 4pol 5pol 9h 6h 6h	3pol 4pol 5pol 7h 7h 7h	3pol 4pol 5pol 2h 2h 2h	3pol 4pol 5pol 10h 10h 10h	Gewicht
16 5		24208	24209				0.320
32 5		24210	24211				0.374

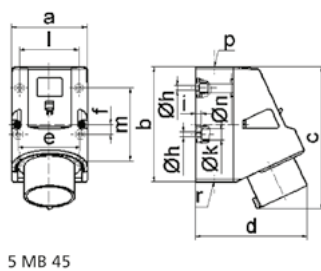

Ampere	16	32	32	32
Polzahl	5	3	4	5
a	83,0	83,0	83,0	83,0
b	126,0	126,0	126,0	126,0
c	155,5	165,0	165,0	166,0
d	122,0	128,0	128,0	130,0
e	68,0	68,0	68,0	68,0
f	11,0	11,0	11,0	11,0
h ø	5,5	5,5	5,5	5,5
i	6,5	6,5	6,5	6,5
k ø	12,0	12,0	12,0	12,0
l	65,0	65,0	65,0	65,0
m	80,0	80,0	80,0	80,0
n ø	10	10,0	10,0	10,0
r	M25	M25	M25	M25
Leiter mm² min	1	2,5	2,5	2,5
Leiter mm² max	2,5	6	6	6

Fasenwisselaars als TCD

- Schroefklemmen
- Vernikkelde contacten
- Beschermingsklasse IP44

		110V 50-60 Hz	230V 50-60 Hz	400V 50-60 Hz	500V 50-60 Hz	>50V 301-500Hz	>50V 100-300Hz	kg	
2P+E	3P+E	3P+E	3P+E	3P+E	3P+E	3P+E	3P+E		
Ampere	Polen	3pol 4pol 5pol 4h 4h 4h	3pol 4pol 5pol 6h 9h 9h	3pol 4pol 5pol 9h 6h 6h	3pol 4pol 5pol 7h 7h 7h	3pol 4pol 5pol 2h 2h 2h	3pol 4pol 5pol 10h 10h 10h	Gewicht	
16	5				2602			0.182	
32	5				2652	2603			0.250



2602

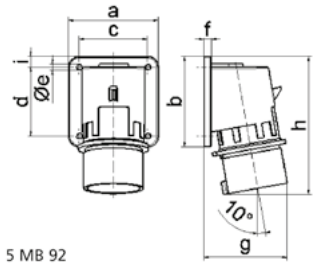

5 MB 92

Ampere	16	32			
Polzahl	5	5			
a	84,0	90,0			
b	84,0	75,0			
c	64,0	78,0			
d	64,0	45,0			
e ø	5,5	5,5			
f	7,0	7,0			
g	78,0	88,0			
h	129,0	139,0			
i	10,0	13,0			
Leiter mm² min	1	2,5			
Leiter mm² max	2,5	6			

Fasenwisselaars als TCD

- Schroefklemmen
- Met klapdeksel
- Vernikkelde contacten
- Aan de achterkant geopend
- Beschermingsklasse IP44

		110V 50-60 Hz	230V 50-60 Hz	400V 50-60 Hz	500V 50-60 Hz	>50V 301-500Hz	>50V 100-300Hz	kg
2P+E	3P+E	3P+E	3P+E	3P+E	3P+E	3P+E	3P+E	
Ampere	Polen	3pol 4pol 5pol 4h 4h 4h	3pol 4pol 5pol 6h 9h 9h	3pol 4pol 5pol 9h 6h 6h	3pol 4pol 5pol 7h 7h 7h	3pol 4pol 5pol 2h 2h 2h	3pol 4pol 5pol 10h 10h 10h	Gewicht
16	5				26020			0.274
32	5				2674			0.342



26020

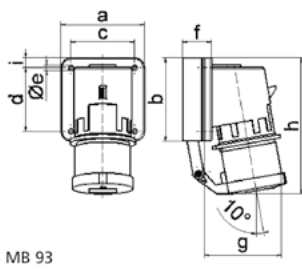

5 MB 93

Ampere	16	32			
Polzahl	5	5			
a	84,0	90,0			
b	84,0	75,0			
c	64,0	78,0			
d	64,0	45,0			
e ø	5,5	5,5			
f	29,0	29,0			
g	105,0	115,0			
h	138,0	150,0			
i	10,0	13,0			
Leiter mm² min	1	2,5			
Leiter mm² max	2,5	6			

Fasenwisselaars als TCD

- Schroefklemmen
- Vernikkelde contacten
- Aan de achterkant open
- Beschermingsklasse IP44

		110V 50-60 Hz	230V 50-60 Hz	400V 50-60 Hz	500V 50-60 Hz	>50V 301-500Hz	>50V 100-300Hz	kg
2P+E	3P+E	3P+E	3P+E	3P+E	3P+E	3P+E	3P+E	
Ampere	Polen	3pol 4pol 5pol 4h 4h 4h	3pol 4pol 5pol 6h 9h 9h	3pol 4pol 5pol 9h 6h 6h	3pol 4pol 5pol 7h 7h 7h	3pol 4pol 5pol 2h 2h 2h	3pol 4pol 5pol 10h 10h 10h	Gewicht
16	5				28181			0.195



28183

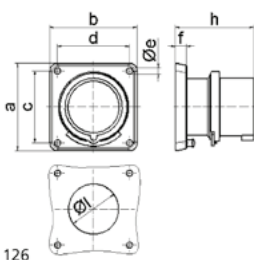

5 MB 126

Ampere	16	16	16	32	32	32
Polzahl	3	4	5	3	4	5
a	85,0	85,0	85,0	85,0	85,0	85,0
b	85,0	85,0	85,0	85,0	85,0	85,0
c	70,0	70,0	70,0	70,0	70,0	70,0
d	70,0	70,0	70,0	70,0	70,0	70,0
e ø	6,3	6,3	6,3	6,3	6,3	6,3
f	11,0	11,0	11,0	11,0	11,0	11,0
h	75,5	75,0	76,5	85,0	85,0	85,0
l ø	49,0	49,0	49,0	49,0	49,0	49,0
Leiter mm² min	1	1	1	2,5	2,5	2,5
Leiter mm² max	2,5	2,5	2,5	6	6	6

Fasenwisselaars als Flens TCD

- Schroefklemmen
- Vernikkelde contacten
- Hittebestendige contactdragers
- Beschermingsklasse IP44

		110V 50-60 Hz	230V 50-60 Hz	400V 50-60 Hz	500V 50-60 Hz	>50V 301-500Hz	>50V 100-300Hz	kg
		3pol 4pol 5pol 4h 4h 4h	3pol 4pol 5pol 6h 9h 9h	3pol 4pol 5pol 9h 6h 6h	3pol 4pol 5pol 7h 7h 7h	3pol 4pol 5pol 2h 2h 2h	3pol 4pol 5pol 10h 10h 10h	Gewicht
16	5	2870						0.138
32	5	2857						0.193



2870

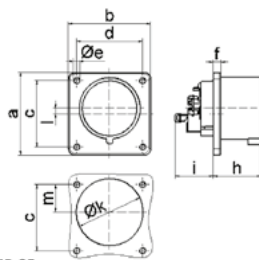

5 MB 85

Ampere Polzahl	16 3	16 4	16 5	32 3	32 4	32 5
a	75,0	75,0	75,0	75,0	75,0	75,0
b	75,0	75,0	75,0	75,0	75,0	75,0
c	60,0	60,0	60,0	60,0	60,0	60,0
d	60,0	60,0	60,0	60,0	60,0	60,0
e o	5,5	5,5	5,5	5,5	5,5	5,5
f	7,0	7,0	7,0	7,0	7,0	7,0
h	43,0	43,0	43,0	53,0	53,0	53,0
i	39,0	39,0	39,0	43,0	43,0	43,0
k o	42,0	48,0	61,0	57,0	57,0	60,0
l	-	-	5,0	2,0	2,0	-
m	30,0	30,0	25,0	28,0	28,0	30,0
Leiter mm² min	1	1	1	2,5	2,5	2,5
Leiter mm² max	2,5	2,5	2,5	6	6	6

CEE-koppeling

- Schroefloze aansluittechniek
- Behuizing met schroefdraad en kliksluiting
- Speciale trekontlasting
- Beschermingsklasse IP54
- Hittebestendige contactdragers
- Loodvrije contacten



300

	Ampere	Polen	110V 50-60 Hz	230V 50-60 Hz	400V 50-60 Hz	500V 50-60 Hz	>50V 301-500Hz	>50V 100-300Hz	kg Gewicht
			3pol 4pol 5pol 4h 4h 4h	3pol 4pol 5pol 6h 9h 9h	3pol 4pol 5pol 9h 6h 6h	3pol 4pol 5pol 7h 7h 7h	3pol 4pol 5pol 2h 2h 2h	3pol 4pol 5pol 10h 10h 10h	
16	3		310	311	312				0.154
16	4			314	315	316		317	
16	5		3110	3111	300				0.200
32	3			3114	3115				0.302
32	4			3117	3118	3119			0.313
32	5				301				0.346

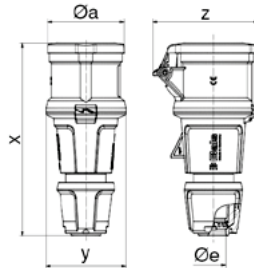

Ampere	16	16	32	32	32
Polzahl	3	5	3	4	5
ø a	55,0	68,0	69,0	69,0	76,0
x	157,0	171,0	205,0	205,0	205,0
y	59,0	71,0	80,0	80,0	80,0
z	80,0	94,0	99,0	99,0	105,0
ø e	18,0	21,0	29,0	29,0	29,0
Cond. mm² min	1	1	2,5	2,5	2,5
Cond. mm² max	2,5	2,5	6,0	6,0	6,0

CEE-koppeling

- Schroefloze klemmen
- 16A 230V 3p
- Behuizingsaansluiting met schroefdraad en kliksluiting
- Speciale trekontlasting
- Beschermingsklasse IP44



3136

	Ampere	Polen	110V 50-60 Hz	230V 50-60 Hz	400V 50-60 Hz	500V 50-60 Hz	>50V 301-500Hz	>50V 100-300Hz	kg Gewicht
			3pol 4pol 5pol 4h 4h 4h	3pol 4pol 5pol 6h 9h 9h	3pol 4pol 5pol 9h 6h 6h	3pol 4pol 5pol 7h 7h 7h	3pol 4pol 5pol 2h 2h 2h	3pol 4pol 5pol 10h 10h 10h	
16	3		3125	3126					0.138
16	4			3129	3130				0.170
16	5			3135	3136				0.180
32	3		3137	3138					0.272
32	4			3141	3142				0.278
32	5			3147	3148				0.318

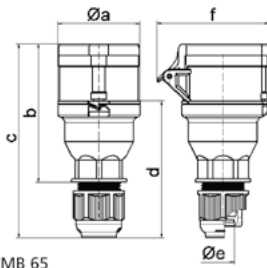

Ampere	16	16	16	32	32	32
Polzahl	3	4	5	3	4	5
a ø	53,0	60,0	66,0	74,5	74,5	74,5
b	100,5	112,5	113,5	133,5	133,5	134,5
c	141,0	153,0	154,0	186,0	186,0	187,0
d	97,5	104,5	105,5	127,5	127,5	128,5
e ø	18,0	18,0	18,0	23,0	23,0	23,0
f	76,0	79,0	86,0	92,0	92,0	97,0
Leiter mm² min	1	1	1	2,5	2,5	2,5
Leiter mm² max	2,5	2,5	2,5	6	6	6

3 MB 65

CEE-koppeling TE-Plus

- Schroefloze klemmen
- Hittebestendige contactdragers
- KONTEX contact
- Vernikkelde contacten
- Speciale trekontlasting
- Beschermingsklasse IP44

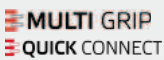

31981

	Ampere	Polen	110V 50-60 Hz	230V 50-60 Hz	400V 50-60 Hz	500V 50-60 Hz	>50V 301-500Hz	>50V 100-300Hz	kg Gewicht
			3pol 4pol 5pol 4h 4h 4h	3pol 4pol 5pol 6h 9h 9h	3pol 4pol 5pol 9h 6h 6h	3pol 4pol 5pol 7h 7h 7h	3pol 4pol 5pol 2h 2h 2h	3pol 4pol 5pol 10h 10h 10h	
16	3		31659	31533	31665	31955	31957	31956	0.142
16	4		31681	31661	31534	31959	31671	31669	0.166
16	5			31662	31536	31964	31966	31965	0.198
32	3		31967	31968		31970	31972	31971	0.270
32	4		31973	31974	31975	31976	31672	31670	0.310
32	5		31979	31664	31981	31884	31984	31983	0.340

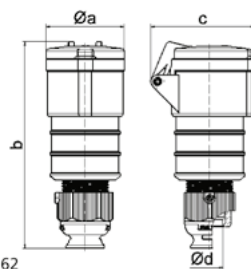

Ampere	16	16	16	32	32	32
Polzahl	3	4	5	3	4	5
a ø	51,0	58,0	65,0	66,5	66,5	72,0
b	156,0	162,0	168,0	195,0	195,0	198,0
c	72,0	78,0	86,0	89,0	89,0	99,0
d ø	18,0	18,0	21,0	23,0	23,0	27,0
Leiter mm² min	1	1	1	2,5	2,5	2,5
Leiter mm² max	2,5	2,5	2,5	6	6	6

3 MB 62

3 SCHUKO- CONTACTMATERIALEN



Schuko-contactmaterialen

<p>Schuko-contactdozen</p>  <p>Pagina 95</p>	<p>Schuko-stekers</p>  <p>Pagina 97</p>	<p>Schuko-koppelingen</p>  <p>Pagina 98</p>
---	--	--

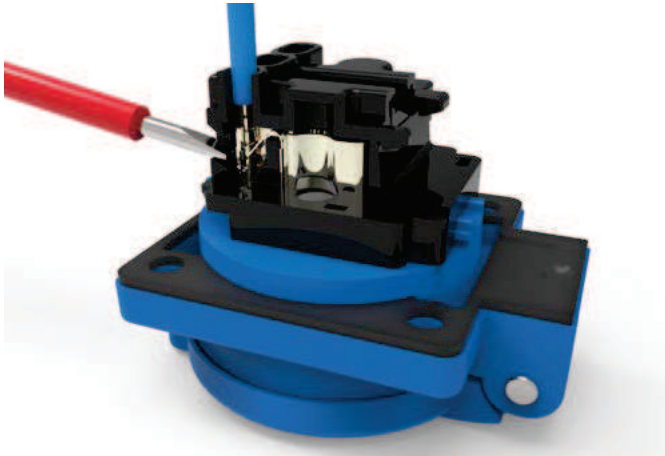

Schuko-inbouwcontactdozen met QUICK CONNECT

- schroefloze verbindingstechnologie
- robuust klem- en behuizing ontwerp
- speciale contacttechnologie voorkomt grotendeels temperatuurstijging als gevolg van contactvorming
- flensafmetingen in 50 x 50 mm en 75 x 75 mm
- leverbaar in Duits, Zwitsers of Belgisch/Frans systeem



- vaste flenspakking
- op verzoek ook met verhoogde aanrakingsbeveiliging
- speciale kleuren op aanvraag
- VDE getest
- veilig om aan te raken volgens BGV A3
- vernikkelde contacten



Bruikbare aderconfiguraties

- vereiste striplengte voor kabelschoenen 10 tot 12 mm
- massieve aders 1,5 mm² tot 2,5 mm²
- flexibele aders 1,5 mm² tot 2,5 mm² met ader-eindhuls, professioneel gekrompen
- flexibele aders 1,5 mm² tot 2,5 mm² ultrasoon gelast



Veilig verbonden

De Schuko-stekers en -koppelingen zijn veilig verbonden met de kabel door de unieke Bals MULTI-GRIP wartel. Deze geïntegreerde kabelwartel realiseert een trekcontlasting die de norm ver overtreft.

MULTI GRIP

- MULTI-GRIP kabelwartel met geïntegreerde trekcontlasting en afdichting
- optimale trekcontlasting voor kleine en grote kabeldiameters
- geen extra montage van een interne trekcontlasting
- het tijdrovende aanpassen van de uienringen aan de kabeldiameters is niet langer nodig

Steker

- beschermingsklasse IP44
- eenvoudige en snelle montage dankzij het gedeelde ontwerp
- royale aansluitruimte
- de oriëntatie van de aansluitingen is hetzelfde voor alle contacten, de aansluitschroeven kunnen dus allemaal vanuit één richting worden bediend.
- de behuizings- en verbindingsschroeven kunnen met één en hetzelfde gereedschap worden vastgeschroefd (kruisgleuf PH2)
- doorsneden van 1 mm² tot 4 mm² kunnen zonder problemen worden aangesloten
- ook geschikt voor Belgisch/Frans systeem
- verschillende kleurvarianten (blauw, rood, zwart en grijs) beschikbaar



Een royale behuizing maakt ongecompliceerde montage mogelijk.

Bovendien zorgt de schroefloze installatie van MULTI-GRIP wartel voor een snelle en zekere installatie.

- snel en veilig sluiten van de schroefverbinding dankzij een dubbele schroefdraad
- de rubberen afdichting, die stevig aan de behuizing is bevestigd, zit vast en dicht betrouwbaar af
- een controle van de trekcontlasting van buitenaf is op elk moment mogelijk

Koppeling

- net als stekers en verder:
- optioneel met verhoogde contactbeveiliging
- ook verkrijgbaar in Belgisch/Frans systeem
- IP54

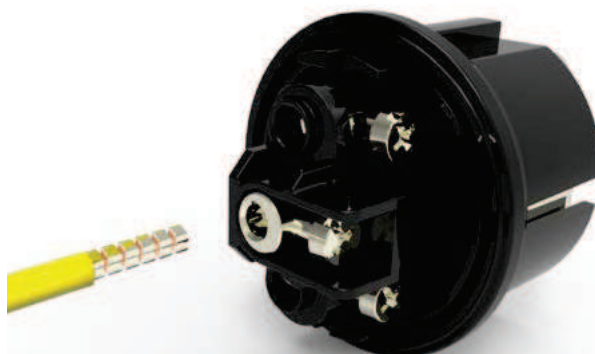

Aders tot maximaal 4 mm² kunnen zonder problemen worden aangesloten.

Schuko-contactdozen

Technische informatie -16/A/250V~
- VDE 0620 / NBN C 61-112-1

Schuko-inbouwcontactdoos

- Schroefklemmen
- Zonder klapdeksel
- Aansluiting achterzijde
- Beschermingsklasse IP20

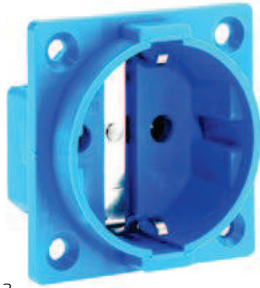

713

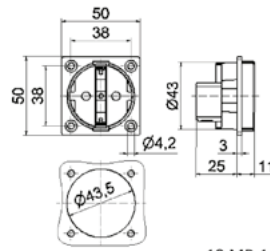

18 MB 1

Uitvoering	Kleur	Bestelnr
Randaarde	Grijs	712
Randaarde	Blauw	713
Randaarde	Zwart	714

Schuko-inbouwcontactdoos

- Schroefklemmen
- Vernikkelde contacten
- Beschermingsklasse IP68



7112

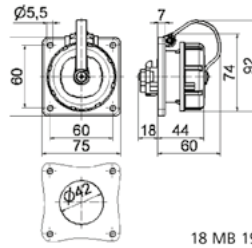

18 MB 19

Uitvoering	Kleur	Bestelnr
Randaarde	Blauw	7112

Schuko-inbouwcontactdoos

- Schroefklemmen
- Vernikkelde contacten
- Beschermingsklasse IP68



7112

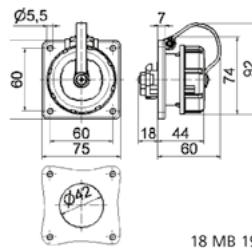

18 MB 19

Uitvoering	Kleur	Bestelnr
Randaarde	Grijs	71028
Penaarde	Blauw	7153

Schuko-inbouwcontactdoos

- Schroefloze klemmen
- Aansluiting volgens BGV A2
- Vernikkelde contacten
- Beschermingsklasse IP54



71118

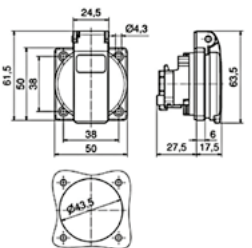

18 MB 103

Uitvoering	Kleur	Bestelnr
Penaarde	Blauw	71118

Schuko-wandcontactdoos

- Schroefklemmen
- Beschermingsklasse IP44



724

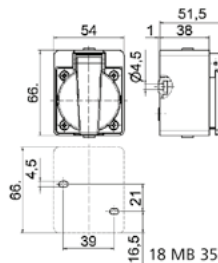

18 MB 35

Uitvoering	Kleur	Bestelnr
Randaarde	Blauw	724

QUICK CONNECT

Schuko-toestelcontactdoos

- Schroefklemmen
- Met afdekdop
- Vernikkelde contacten
- Ook geschikt voor Belgisch/Frans systeem
- Beschermingsklasse IP67



754

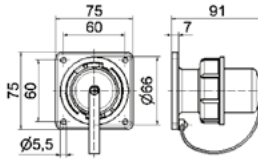

18 MB 16

Uitvoering	Kleur	Bestelnr
Randaarde	Blauw	754
Randaarde	Grijs	755

Schuko-inbouwcontactdoos

- Met vaste pakking
- Aansluiting volgens BGV A2
- Vernikkelde contacten
- Beschermingsklasse IP54



71099

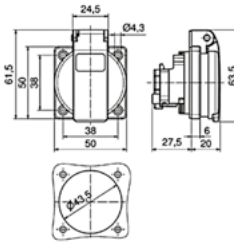

18 MB 102

Uitvoering	Kleur	Bestelnr
Randaarde	Blauw	71094
Randaarde	Grijs	71095
Randaarde	Zwart	71097

Schuko-inbouwcontactdoos voor verplaatsbare verdelers

- Met extra afdichting en vaste pakking
- Aansluiting volgens BGV A2
- Vernikkelde contacten
- Beschermingsklasse IP54



71102

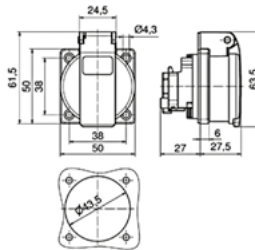

18 MB 104

Uitvoering	Kleur	Bestelnr
Randaarde	Blauw	71082

Schuko-inbouwcontactdoos

- Vernikkelde contacten
- Beschermingsklasse IP54



71108

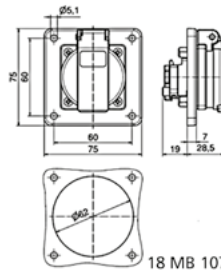

18 MB 107

Uitvoering	Kleur	Bestelnr
Randaarde	Blauw	71105

Schuko-stekers

Technische informatie - 16/A/250V~
 - VDE 0620 / NBN C 61-112-1

Schuko-steker

- Schroefklemmen
- MULTI-GRIP wartel
- Extra grote aansluiting
- Ook geschikt voor Belgisch/Frans systeem
- Beschermingsklasse IP44
- Geschikt voor moeilijke omstandigheden



7370

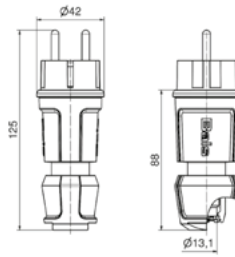

18 MB 119

Uitvoering	Kleur	Bestelnr
Randaarde	Blauw	7370

Schuko-steker

- Schroefklemmen
- Vernikkelde contacten
- Ook geschikt voor Belgisch/Frans systeem
- Met afdekdop
- Beschermingsklasse IP67

736

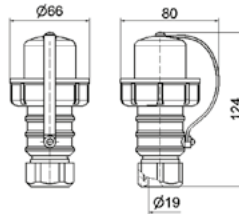

18 MB 18

Uitvoering	Kleur	Bestelnr
Randaarde	Blauw	736
Randaarde	Grijs	737

Schuko-koppeling

- Schroefklemmen
- MULTI-GRIP wartel
- Extra grote aansluiting
- Beschermingsklasse IP44
- Geschikt voor Duits systeem



7486

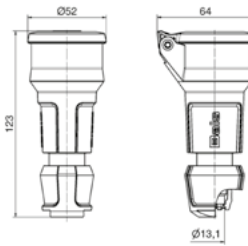

18 MB 120

Uitvoering	Kleur	Bestelnr
Randaarde	Blauw	7486
Randaarde	Zwart	7488

Schuko-koppeling

- Schroefklemmen
- met wartel
- Vernikkelde contacten
- Beschermingsklasse IP68
- Geschikt voor Duits systeem

746

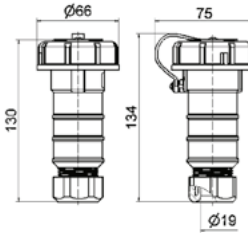

18 MB 26

Uitvoering	Kleur	Bestelnr
Randaarde	Blauw	746
Randaarde	Grijs	747

Schuko-koppeling

- Schroefklemmen
- met wartel
- Vernikkelde contacten
- Beschermingsklasse IP68
- Ook geschikt voor Belgisch/Frans systeem

746

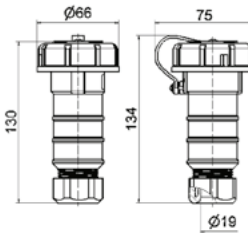

18 MB 26

Uitvoering	Kleur	Bestelnr
Penaarde	Blauw	7416
Penaarde	Grijs	7455

Schuko-driewegkoppeling

- Schroefklemmen
- Met wartel
- Vernikkelde contacten
- Met ophanghaak
- Beschermingsklasse IP68
- Geschikt voor Duits systeem

749

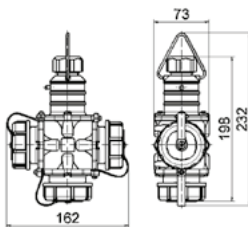

18 MB 27

Uitvoering	Kleur	Bestelnr
Randaarde	Blauw	749

Schuko-driewegkoppeling

- Schroefklemmen
- met wartel
- Vernikkelde contacten
- Beschermingsklasse IP68
- met ophanghaak
- Ook geschikt voor Belgisch/Frans systeem

749

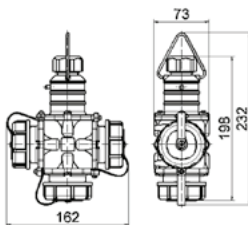

18 MB 27

Uitvoering	Kleur	Bestelnr
Penaarde	Blauw	7432

4 VERDELERS



Klapvensters IP44

<p>VARIABOX IP44 Small</p>  <p>Pagina 103</p>	<p>VARIABOX IP44 Medium</p>  <p>Pagina 105</p>	<p>VARIABOX IP44 Large</p>  <p>Pagina 111</p>	<p>VARIABOX IP44 XL</p>  <p>Pagina 116</p>	<p>VARIABOX IP44 XXL</p>  <p>Pagina 119</p>
--	---	--	---	--

Klapvensters IP44

<p>Accessoires en onderdelen, klapvenster, aanrakingsveilig</p>  <p>Pagina 122</p>

Klapvensters IP44

<p>Accessoires en onderdelen, klapvenster, niet aanrakingsveilig</p>  <p>Pagina 122</p>	<p>Accessoires en onderdelen, klapvenster, met montagerail</p>  <p>Pagina 123</p>	<p>Slotgarnituur tbv klapvensters</p>  <p>Pagina 123</p>	<p>DIN-schroeven tbv klapvensters</p>  <p>Pagina 124</p>
--	--	---	---

Klapvensters IP44

<p>Accessoires en onderdelen, klapvenster, niet aanrakingsveilig</p>  <p>Pagina 122</p>
--

VARIABOX

De VARIABOX verdelers van Bals zijn nu nog veelzijdiger en flexibeler. Ter uitbreiding van de mogelijkheden zijn nu de afschakelbaar/vergrendelbaar CEE-contactdozen beschikbaar en de nieuwe netwerkcontactdozen. De verdeelkasten kunnen daarmee naar wens worden uitgerust met de meest gangbare RJ45-, HDMI- of USB-aansluitingen.

De gecodeerde flensplaat met aparte schakelaar is geschikt voor de mechanisch vergrendelde opbouwcontactdoos van 16A 3-polig tot en met 32A 5-polig in IP44 of IP67 en past perfect in het visuele uiterlijk van het totaalsysteem.

VARIABOX maakt daarmee opnieuw zijn reputatie waar als een echte allrounder onder de verdeelkasten. Met de versies S, M, L, XL en XXL als wand- of mobiele verdeler is altijd een VARIABOX samen te stellen die aan uw vereisten voldoet.

Neem contact op met team Bals Nederland voor een maatwerk advies: +31-(0)23 547 09 47 of mail naar verkoop@bals.nl.

VARIABOX-uitbreiding afschakelbaar/vergrendelbaar:

- perfecte visuele integratie in het bestaande systeem
- gebruiksvriendelijke indeling voor meerdere eenheden
- mechanische dubbele vergrendeling
- vergrendelbaar in 0-stand
- vernikkelde contacten
- hittebestendige contactdragers
- grotere flexibiliteit in het VARIABOX systeemlandschap
- geschikt voor zware omgevingsomstandigheden
- versies in alle gangbare uurstanden van 16A 3-polig tot 32A 5-polig.
- beschermingsklassen IP44, IP54 en IP67

VARIABOX-uitbreiding netwerk contactdoos:

- perfecte visuele integratie in het bestaande systeem
- kan naar wens worden uitgerust met RJ45, HDMI of USB
- verschillende datatechnologie-inzetstukken beschikbaar
- met aanraakbeveiliging
- beschermingsklasse IP54
- grotere flexibiliteit in het VARIABOX systeemlandschap
- klapdeksel afsluitbaar wanneer aangesloten en optioneel vergrendelbaar
- met labelvelden

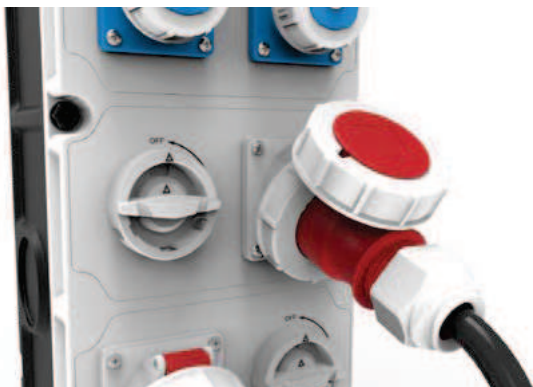

Detail van de afschakelbaar/vergrendelbaar flensplaat.

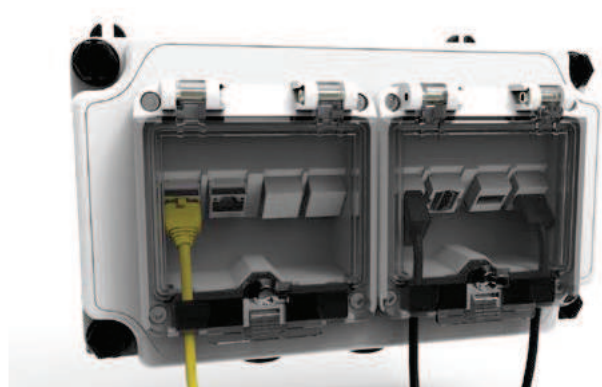

Datanetwerkaansluiting met mogelijkheid voor verschillende inzetstukken.

Technische informatie VARIABOX

Maten		Hittebestendigheid	NEN-EN-IEC 61439 / VDE 0660
versie	afmeting (H x B x D)	Bestand tegen veroudering	langetermijntest bij +80°C
VARIABOX-S	130 x 230 x 145 mm	Gloeidraadtest	volgens NEN-EN-IEC 60695
VARIABOX-M	260 x 230 x 145 mm	Bescherming	het bovenste deel kan verzegeld worden aan het onderste deel, OTC klapvenster verzegelbaar
VARIABOX-L	390 x 230 x 145 mm	Wandmontage	optionele montage van binnenuit of van buitenaf
VARIABOX-XL	520 x 230 x 145 mm	Dekselbevestiging	rechts scharnierend, optioneel links mogelijk
VARIABOX-XXL	650 x 230 x 145 mm	Afdekschroeven	geborgd, met binnen- en buitenszekant, inclusief sleuf, koppel 2 Nm
VARIABOX-L DUO	390 x 460 x 145 mm	Kabelinvoer	Voorbereid om te openen aan boven- en onderkant, respectievelijk M12, M20, M25/M32/M40
VARIABOX-XL DUO	520 x 460 x 145 mm	Onderdelen	klapvenster met gebruiksvriendelijk OTC-mechanisme (One Touch Close), CEE-contactdozen 16A tot 63A met onderhoudsvrije QUICK-CONNECT verbindingstechnologie, datacontactdozen, intercompatibiliteit van opbouwcontactdozen, optioneel verkrijgbaar met draaggreep
	verdere modulaire uitbreiding mogelijk	Beschermingsklasse	IP44, IP54, IP67
Kleuren	bovenkant grijs (standaard) RAL 7035 bovenkant geel, verkrijgbaar vanaf 5 stuks bovenkant blauw, verkrijgbaar vanaf 5 stuks bovenkant rood, verkrijgbaar vanaf 5 stuks onderkant zwart RAL 9005		
Vorm	deksel recht, CEE-contactdozen schuin		
Materiaal	PBT Polyester		
Materiaaleigenschappen	zelfdovend, hittebestendig, zeer koudebestendig, verouderingsbestendig, zeewaterbestendig, goede elektrische isolatie, slagvast, slijtvast, dimensionaal stabiel		
Lange levensduur	hoge chemische weerstand, UV-gestabiliseerd, geschikt voor gebruik in ruwe omgevingen		
Slagvastheid	IK09		

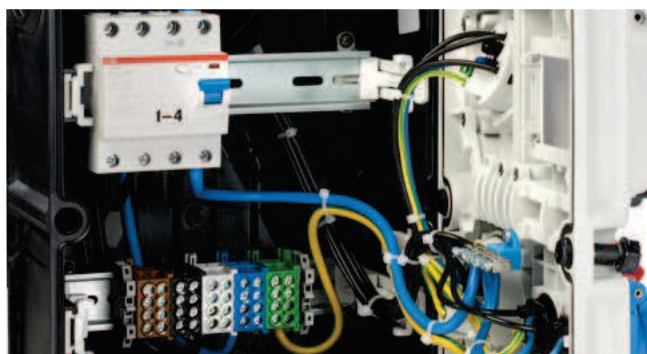

Overzichtelijke bedrading in overeenstemming met voorschriften



Alle opbouwcontactdozen met QUICK-CONNECT aansluittechniek



Het klapvenster met het unieke OTC-mechanisme



De voorbereide metrische kabelingangen aan de bovenkant

Technische informatie - compleet bedraad, gereed voor installatie
 - beschermingsgraad IP44
 - alle verdelers conform NEN-EN-IEC 61439

VARIABOX

- Direct aansluitbaar
- Bescherming klasse IP44

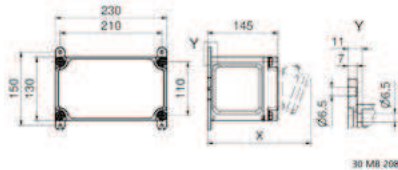

Tiefenmaß/ depth X (mm)		
Bezeichnung/ with	IP44	IP67
OTC Klappel/ OTC opening window	190	190
Schutzk. Steckdose/Steckdose: spindel	162	205
CEE 16A 3p	200	200
CEE 16A 4p	204	202
CEE 16A 5p	207	205
CEE 32A 3p/4p	211	213
CEE 32A 5p	218	214
CEE 63A 3p/4p/5p	220	231

Bestell-Nr. K13110001

Afmetingen: 130 x 230 x 145mm (HxBxD)
 Ingang bovenzijde: 2x M25 + 1x M20 + 1x M12
 Ingang onderzijde: 2x M25 + 1x M20 + 1x M12
 Kabel: aan te sluiten op klemmenblok 16qmm
 Uitgangen:
 3x Schuko IP44



Bestell-Nr. K13110002

Afmetingen: 130 x 230 x 145mm (HxBxD)
 Ingang bovenzijde: 2x M25 + 1x M20 + 1x M12
 Ingang onderzijde: 2x M25 + 1x M20 + 1x M12
 Kabel: aan te sluiten op klemmenblok 16qmm
 Uitgangen:
 4x Schuko IP44



Bestell-Nr. K13110003

Afmetingen: 130 x 230 x 145mm (HxBxD)
 Ingang bovenzijde: 2x M25 + 1x M20 + 1x M12
 Ingang onderzijde: 2x M25 + 1x M20 + 1x M12
 Kabel: aan te sluiten op klemmenblok 16qmm
 Uitgangen:
 1x Schuko IP44
 1x CEE-contactdoos 16A 3p 230V IP44 sch



Bestell-Nr. K13110004

Afmetingen: 130 x 230 x 145mm (HxBxD)
 Ingang bovenzijde: 2x M25 + 1x M20 + 1x M12
 Ingang onderzijde: 2x M25 + 1x M20 + 1x M12
 Kabel: aan te sluiten op klemmenblok 16qmm
 Uitgangen:
 2x Schuko IP44
 1x CEE-contactdoos 16A 3p 230V IP44 sch



Bestell-Nr. K13110005

Afmetingen: 130 x 230 x 145mm (HxBxD)
 Ingang bovenzijde: 2x M25 + 1x M20 + 1x M12
 Ingang onderzijde: 2x M25 + 1x M20 + 1x M12
 Kabel: aan te sluiten op klemmenblok 16qmm
 Uitgangen:
 1x Schuko IP44
 1x CEE-contactdoos 16A 5p 400V IP44 sch



Bestell-Nr. K13110006

Afmetingen: 130 x 230 x 145mm (HxBxD)
 Ingang bovenzijde: 2x M25 + 1x M20 + 1x M12
 Ingang onderzijde: 2x M25 + 1x M20 + 1x M12
 Kabel: aan te sluiten op klemmenblok 16qmm
 Uitgangen:
 2x Schuko IP44
 1x CEE-contactdoos 16A 5p 400V IP44 sch

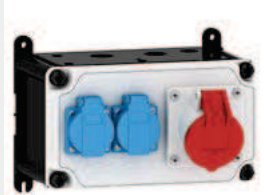

Technische informatie - compleet bedraad, gereed voor installatie
 - beschermingsgraad IP44
 - alle verdelers conform NEN-EN-IEC 61439

Bestell-Nr. K13110007

Afmetingen: 130 x 230 x 145mm (HxBxD)
 Ingang bovenzijde: 2x M25 + 1x M20 + 1x M12
 Ingang onderzijde: 2x M25 + 1x M20 + 1x M12
 Kabel: aan te sluiten op klemmenblok 16qmm
 Uitgangen:
 2x Schuko IP44
 1x CEE-contactdoos 32A 5p 400V IP44 sch

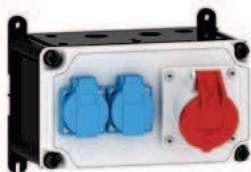
**Bestell-Nr. K13110008**

Afmetingen: 130 x 230 x 145mm (HxBxD)
 Ingang bovenzijde: 2x M25 + 1x M20 + 1x M12
 Ingang onderzijde: 2x M25 + 1x M20 + 1x M12
 Kabel: aan te sluiten op klemmenblok 16qmm
 Uitgangen:
 2x CEE-contactdoos 16A 5p 400V IP44 sch

**Bestell-Nr. K13110009**

Afmetingen: 130 x 230 x 145mm (HxBxD)
 Ingang bovenzijde: 2x M25 + 1x M20 + 1x M12
 Ingang onderzijde: 2x M25 + 1x M20 + 1x M12
 Kabel: aan te sluiten op klemmenblok 16qmm
 Uitgangen:
 2x CEE-contactdoos 32A 5p 400V IP44 sch



Technische informatie - compleet bedraad, gereed voor installatie
 - beschermingsgraad IP44
 - alle verdelers conform NEN-EN-IEC 61439

VARIABOX

- Direct aansluitbaar
- Bescherming klasse IP44

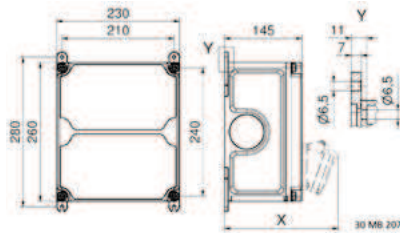

Bezeichnung/ with	IP44	IP67
OTC Klappfl. OTC operating window	180	180
Schutz. Steckdosekontakt socket	162	205
CEE 16A 3p	200	200
CEE 16A 4p	204	202
CEE 16A 5p	207	205
CEE 32A 3p/4p	211	213
CEE 32A 5p	213	214
CEE 63A 3p/4p/5p	229	231

Bestell-Nr. K12210546

Afmetingen: 260 x 230 x 145mm (HxBxD)
 Ingang bovenzijde: 2x M25 + 1x M20 + 1x M12
 Ingang onderzijde: 2x M25 + 1x M20 + 1x M12
 Kabel: aan te sluiten op klemmenblok 16qmm
 Rdf: 0,79
 I Nom.: 40A
 Uitgangen:
 3x Schuko IP44
 bev. met 3x automaat 16A C 1p+Na
 Alles beveiligd met de volgende aardlek's
 1x aardlek 40A 0.03A 4p



Bestell-Nr. K12210547

Afmetingen: 260 x 230 x 145mm (HxBxD)
 Ingang bovenzijde: 2x M25 + 1x M20 + 1x M12
 Ingang onderzijde: 2x M25 + 1x M20 + 1x M12
 Kabel: aan te sluiten op klemmenblok 16qmm
 Rdf: 0,75
 I Nom.: 40A
 Uitgangen:
 2x Schuko IP44
 bev. met 2x automaat 16A C 1p+Na
 1x CEE-contactdoos 16A 5p 400V IP44 sch
 bev. met 1x automaat 16A C 3p+Na
 Alles beveiligd met de volgende aardlek's
 1x aardlek 40A 0.03A 4p



Bestell-Nr. K12210548

Afmetingen: 260 x 230 x 145mm (HxBxD)
 Ingang bovenzijde: 2x M25 + 1x M20 + 1x M12
 Ingang onderzijde: 2x M25 + 1x M20 + 1x M12
 Kabel: aan te sluiten op klemmenblok 16qmm
 Rdf: 0,80
 I Nom.: 40A
 Uitgangen:
 4x Schuko IP44
 bev. met 4x automaat 16A C 1p+Na
 Alles beveiligd met de volgende aardlek's
 1x aardlek 40A 0.03A 4p



Bestell-Nr. K12210549

Afmetingen: 260 x 230 x 145mm (HxBxD)
 Ingang bovenzijde: 2x M25 + 1x M20 + 1x M12
 Ingang onderzijde: 2x M25 + 1x M20 + 1x M12
 Kabel: aan te sluiten op klemmenblok 16qmm
 Rdf: 0,67
 I Nom.: 40A
 Uitgangen:
 2x Schuko IP44
 bev. met 2x automaat 16A C 1p+Na
 1x CEE-contactdoos 32A 5p 400V IP44 sch
 bev. met 1x automaat 32A C 3p+Na
 Alles beveiligd met de volgende aardlek's
 1x aardlek 40A 0.03A 4p



Bestell-Nr. K12210568

Afmetingen: 260 x 230 x 145mm (HxBxD)
 Ingang bovenzijde: 2x M25 + 1x M20 + 1x M12
 Ingang onderzijde: 2x M25 + 1x M20 + 1x M12
 Kabel: aan te sluiten op klemmenblok 16qmm
 Rdf: 0,92
 I Nom.: 40A
 Uitgangen:
 3x Schuko IP44
 bev. met 3x aardlekautomaat 16A C 0,03A 2p



Bestell-Nr. K12210569

Afmetingen: 260 x 230 x 145mm (HxBxD)
 Ingang bovenzijde: 2x M25 + 1x M20 + 1x M12
 Ingang onderzijde: 2x M25 + 1x M20 + 1x M12
 Kabel: aan te sluiten op klemmenblok 16qmm
 Rdf: 0,79
 I Nom.: 40A
 Uitgangen:
 4x Schuko IP44
 bev. met 4x aardlekautomaat 16A C 0,03A 2p



Technische informatie - compleet bedraad, gereed voor installatie
- beschermingsgraad IP44
- alle verdelers conform NEN-EN-IEC 61439

Bestell-Nr. K12210570

Afmetingen: 260 x 230 x 145mm (HxBxD)
Ingang bovenzijde: 2x M25 + 1x M20 + 1x M12
Ingang onderzijde: 2x M25 + 1x M20 + 1x M12
Kabel: aan te sluiten op klemmenblok 16qmm
Rdf: 0,85
I Nom.: 40A
Uitgangen:
2x Schuko IP44
bev. met 2x aardlekautomaat 16A C 0,03A 2p
1x CEE-contactdoos 16A 5p 400V IP44 sch
bev. met 1x aardlekautomaat 16A C 0,03A 4p



Bestell-Nr. K12210572

Afmetingen: 260 x 230 x 145mm (HxBxD)
Ingang bovenzijde: 2x M32 + 1x M20 + 1x M12
Ingang onderzijde: 2x M32 + 1x M20 + 1x M12
Kabel: aan te sluiten op klemmenblok 16qmm
Rdf: 0,92
I Nom.: 40A
Uitgangen:
2x CEE-contactdoos 16A 5p 400V IP44 sch
bev. met 2x aardlekautomaat 16A C 0,03A 4p



Bestell-Nr. K12210573

Afmetingen: 260 x 230 x 145mm (HxBxD)
Ingang bovenzijde: 2x M32 + 1x M20 + 1x M12
Ingang onderzijde: 2x M32 + 1x M20 + 1x M12
Kabel: aan te sluiten op klemmenblok 16qmm
Rdf: 0,71
I Nom.: 63A
Uitgangen:
1x CEE-contactdoos 16A 5p 400V IP44 sch
bev. met 1x aardlekautomaat 16A C 0,03A 4p
1x CEE-contactdoos 32A 5p 400V IP44 sch
bev. met 1x aardlekautomaat 32A C 0,03A 4p



Bestell-Nr. K12210574

Afmetingen: 260 x 230 x 145mm (HxBxD)
Ingang bovenzijde: 2x M32 + 1x M20 + 1x M12
Ingang onderzijde: 2x M32 + 1x M20 + 1x M12
Kabel: aan te sluiten op klemmenblok 16qmm
Rdf: 0,60
I Nom.: 63A
Uitgangen:
2x CEE-contactdoos 32A 5p 400V IP44 sch
bev. met 2x aardlekautomaat 32A C 0,03A 4p



Bestell-Nr. K13210010

Afmetingen: 260 x 230 x 145mm (HxBxD)
Ingang bovenzijde: 2x M25 + 1x M20 + 1x M12
Ingang onderzijde: 2x M25 + 1x M20 + 1x M12
Kabel: aan te sluiten op klemmenblok 16qmm
Uitgangen:
2x Schuko IP44



Bestell-Nr. K13210012

Afmetingen: 260 x 230 x 145mm (HxBxD)
Ingang bovenzijde: 2x M25 + 1x M20 + 1x M12
Ingang onderzijde: 2x M25 + 1x M20 + 1x M12
Kabel: aan te sluiten op klemmenblok 16qmm
Rdf: 1
I Nom.: 32A
Uitgangen:
2x Schuko IP44
bev. met 2x automaat 16A C 1p



Bestell-Nr. K13210013

Afmetingen: 260 x 230 x 145mm (HxBxD)
Ingang bovenzijde: 2x M25 + 1x M20 + 1x M12
Ingang onderzijde: 2x M25 + 1x M20 + 1x M12
Kabel: aan te sluiten op klemmenblok 16qmm
Uitgangen:
2x Schuko IP44
Alles beveiligd met de volgende aardlek's
1x aardlek 25A 0.03A 2p



Bestell-Nr. K13210014

Afmetingen: 260 x 230 x 145mm (HxBxD)
Ingang bovenzijde: 2x M25 + 1x M20 + 1x M12
Ingang onderzijde: 2x M25 + 1x M20 + 1x M12
Kabel: aan te sluiten op klemmenblok 16qmm
Uitgangen:
2x Schuko IP44
bev. met 2x automaat 16A C 1p
Alles beveiligd met de volgende aardlek's
1x aardlek 25A 0.03A 2p



Technische informatie - compleet bedraad, gereed voor installatie
 - beschermingsgraad IP44
 - alle verdelers conform NEN-EN-IEC 61439

Bestell-Nr. K13210016

Afmetingen: 260 x 230 x 145mm (HxBxD)
 Ingang bovenzijde: 2x M25 + 1x M20 + 1x M12
 Ingang onderzijde: 2x M25 + 1x M20 + 1x M12
 Kabel: aan te sluiten op klemmenblok 16qmm
 Rdf: 1
 I Nom.: 32A
 Uitgangen:
 3x Schuko IP44
 bev. met 3x automaat 16A C 1p

**Bestell-Nr. K13210017**

Afmetingen: 260 x 230 x 145mm (HxBxD)
 Ingang bovenzijde: 2x M25 + 1x M20 + 1x M12
 Ingang onderzijde: 2x M25 + 1x M20 + 1x M12
 Kabel: aan te sluiten op klemmenblok 16qmm
 Uitgangen:
 3x Schuko IP44
 bev. met 3x automaat 16A C 1p
 Alles beveiligd met de volgende aardlek's
 1x aardlek 40A 0.03A 4p

**Bestell-Nr. K13210019**

Afmetingen: 260 x 230 x 145mm (HxBxD)
 Ingang bovenzijde: 2x M25 + 1x M20 + 1x M12
 Ingang onderzijde: 2x M25 + 1x M20 + 1x M12
 Kabel: aan te sluiten op klemmenblok 16qmm
 Uitgangen:
 4x Schuko IP44
 bev. met 4x automaat 16A C 1p

**Bestell-Nr. K13210020**

Afmetingen: 260 x 230 x 145mm (HxBxD)
 Ingang bovenzijde: 2x M25 + 1x M20 + 1x M12
 Ingang onderzijde: 2x M25 + 1x M20 + 1x M12
 Kabel: aan te sluiten op klemmenblok 16qmm
 Uitgangen:
 4x Schuko IP44
 bev. met 2x automaat 16A C 1p
 Alles beveiligd met de volgende aardlek's
 1x aardlek 40A 0.03A 4p

**Bestell-Nr. K13210021**

Afmetingen: 260 x 230 x 145mm (HxBxD)
 Ingang bovenzijde: 2x M25 + 1x M20 + 1x M12
 Ingang onderzijde: 2x M25 + 1x M20 + 1x M12
 Kabel: aan te sluiten op klemmenblok 16qmm
 Uitgangen:
 4x Schuko IP44
 bev. met 4x automaat 16A C 1p
 Alles beveiligd met de volgende aardlek's
 1x aardlek 40A 0.03A 4p

**Bestell-Nr. K13210022**

Afmetingen: 260 x 230 x 145mm (HxBxD)
 Ingang bovenzijde: 2x M25 + 1x M20 + 1x M12
 Ingang onderzijde: 2x M25 + 1x M20 + 1x M12
 Kabel: aan te sluiten op klemmenblok 16qmm
 Uitgangen:
 6x Schuko IP44

**Bestell-Nr. K13210023**

Afmetingen: 260 x 230 x 145mm (HxBxD)
 Ingang bovenzijde: 2x M25 + 1x M20 + 1x M12
 Ingang onderzijde: 2x M25 + 1x M20 + 1x M12
 Kabel: aan te sluiten op klemmenblok 16qmm
 Uitgangen:
 8x Schuko IP44

**Bestell-Nr. K13210026**

Afmetingen: 260 x 230 x 145mm (HxBxD)
 Ingang bovenzijde: 2x M25 + 1x M20 + 1x M12
 Ingang onderzijde: 2x M25 + 1x M20 + 1x M12
 Kabel: aan te sluiten op klemmenblok 16qmm
 Uitgangen:
 1x Schuko IP44
 bev. met 1x automaat 16A C 1p
 1x CEE-contactdoos 16A 5p 400V IP44 sch



Technische informatie - compleet bedraad, gereed voor installatie
- beschermingsgraad IP44
- alle verdelers conform NEN-EN-IEC 61439

Bestell-Nr. K13210027

Afmetingen: 260 x 230 x 145mm (HxBxD)
Ingang bovenzijde: 2x M25 + 1x M20 + 1x M12
Ingang onderzijde: 2x M25 + 1x M20 + 1x M12
Kabel: aan te sluiten op klemmenblok 16qmm
Uitgangen:
1x Schuko IP44
bev. met 1x automaat 16A C 1p
1x CEE-contactdoos 16A 5p 400V IP44 sch
bev. met 1x automaat 16A C 3p



Bestell-Nr. K13210028

Afmetingen: 260 x 230 x 145mm (HxBxD)
Ingang bovenzijde: 2x M25 + 1x M20 + 1x M12
Ingang onderzijde: 2x M25 + 1x M20 + 1x M12
Kabel: aan te sluiten op klemmenblok 16qmm
Uitgangen:
1x Schuko IP44
1x CEE-contactdoos 16A 5p 400V IP44 sch
Alles beveiligd met de volgende aardlek's
1x aardlek 40A 0.03A 4p



Bestell-Nr. K13210030

Afmetingen: 260 x 230 x 145mm (HxBxD)
Ingang bovenzijde: 2x M25 + 1x M20 + 1x M12
Ingang onderzijde: 2x M25 + 1x M20 + 1x M12
Kabel: aan te sluiten op klemmenblok 16qmm
Uitgangen:
1x Schuko IP44
bev. met 1x automaat 16A C 1p
1x CEE-contactdoos 16A 5p 400V IP44 sch
Alles beveiligd met de volgende aardlek's
1x aardlek 40A 0.03A 4p



Bestell-Nr. K13210031

Afmetingen: 260 x 230 x 145mm (HxBxD)
Ingang bovenzijde: 2x M25 + 1x M20 + 1x M12
Ingang onderzijde: 2x M25 + 1x M20 + 1x M12
Kabel: aan te sluiten op klemmenblok 16qmm
Uitgangen:
1x Schuko IP44
bev. met 1x automaat 16A C 1p
1x CEE-contactdoos 16A 5p 400V IP44 sch
bev. met 1x automaat 16A C 3p
Alles beveiligd met de volgende aardlek's
1x aardlek 40A 0.03A 4p



Bestell-Nr. K13210035

Afmetingen: 260 x 230 x 145mm (HxBxD)
Ingang bovenzijde: 2x M25 + 1x M20 + 1x M12
Ingang onderzijde: 2x M25 + 1x M20 + 1x M12
Kabel: aan te sluiten op klemmenblok 16qmm
Uitgangen:
2x Schuko IP44
bev. met 2x automaat 16A C 1p
1x CEE-contactdoos 16A 5p 400V IP44 sch
bev. met 1x automaat 16A C 3p



Bestell-Nr. K13210037

Afmetingen: 260 x 230 x 145mm (HxBxD)
Ingang bovenzijde: 2x M25 + 1x M20 + 1x M12
Ingang onderzijde: 2x M25 + 1x M20 + 1x M12
Kabel: aan te sluiten op klemmenblok 16qmm
Uitgangen:
2x Schuko IP44
bev. met 2x automaat 16A C 1p
1x CEE-contactdoos 16A 5p 400V IP44 sch
Alles beveiligd met de volgende aardlek's
1x aardlek 40A 0.03A 4p



Bestell-Nr. K13210038

Afmetingen: 260 x 230 x 145mm (HxBxD)
Ingang bovenzijde: 2x M25 + 1x M20 + 1x M12
Ingang onderzijde: 2x M25 + 1x M20 + 1x M12
Kabel: aan te sluiten op klemmenblok 16qmm
Uitgangen:
2x Schuko IP44
bev. met 2x automaat 16A C 1p
1x CEE-contactdoos 16A 5p 400V IP44 sch
bev. met 1x automaat 16A C 3p
Alles beveiligd met de volgende aardlek's
1x aardlek 40A 0.03A 4p



Bestell-Nr. K13210042

Afmetingen: 520 x 230 x 145mm (HxBxD)
Ingang bovenzijde: 2x M25 + 1x M20 + 1x M12
Ingang onderzijde: 2x M25 + 1x M20 + 1x M12
Kabel: aan te sluiten op klemmenblok 16qmm
Uitgangen:
1x Schuko IP44
bev. met 1x automaat 16A C 1p
1x CEE-contactdoos 32A 5p 400V IP44 sch
bev. met 1x automaat 32A C 3p



Technische informatie - compleet bedraad, gereed voor installatie
 - beschermingsgraad IP44
 - alle verdelers conform NEN-EN-IEC 61439

Bestell-Nr. K13210043

Afmetingen: 260 x 230 x 145mm (HxBxD)
 Ingang bovenzijde: 2x M25 + 1x M20 + 1x M12
 Ingang onderzijde: 2x M25 + 1x M20 + 1x M12
 Kabel: aan te sluiten op klemmenblok 16qmm
 Uitgangen:
 1x Schuko IP44
 bev. met 1x automaat 16A C 1p
 1x CEE-contactdoos 32A 5p 400V IP44 sch
 bev. met 1x automaat 32A C 3p
 Alles beveiligd met de volgende aardlek's
 1x aardlek 40A 0.03A 4p

**Bestell-Nr. K13210046**

Afmetingen: 260 x 230 x 145mm (HxBxD)
 Ingang bovenzijde: 2x M32 + 1x M20 + 1x M12
 Ingang onderzijde: 2x M32 + 1x M20 + 1x M12
 Kabel: aan te sluiten op klemmenblok 16qmm
 Uitgangen:
 2x Schuko IP44
 bev. met 2x automaat 16A C 1p
 1x CEE-contactdoos 32A 5p 400V IP44 sch
 bev. met 1x automaat 32A C 3p

**Bestell-Nr. K13210048**

Afmetingen: 260 x 230 x 145mm (HxBxD)
 Ingang bovenzijde: 2x M32 + 1x M20 + 1x M12
 Ingang onderzijde: 2x M32 + 1x M20 + 1x M12
 Kabel: aan te sluiten op klemmenblok 16qmm
 Uitgangen:
 2x Schuko IP44
 bev. met 2x automaat 16A C 1p
 1x CEE-contactdoos 32A 5p 400V IP44 sch
 Alles beveiligd met de volgende aardlek's
 1x aardlek 40A 0.03A 4p

**Bestell-Nr. K13210049**

Afmetingen: 260 x 230 x 145mm (HxBxD)
 Ingang bovenzijde: 2x M32 + 1x M20 + 1x M12
 Ingang onderzijde: 2x M32 + 1x M20 + 1x M12
 Kabel: aan te sluiten op klemmenblok 16qmm
 Uitgangen:
 2x Schuko IP44
 bev. met 2x automaat 16A C 1p
 1x CEE-contactdoos 32A 5p 400V IP44 sch
 bev. met 1x automaat 32A C 3p
 Alles beveiligd met de volgende aardlek's
 1x aardlek 40A 0.03A 4p

**Bestell-Nr. K13210051**

Afmetingen: 260 x 230 x 145mm (HxBxD)
 Ingang bovenzijde: 2x M32 + 1x M20 + 1x M12
 Ingang onderzijde: 2x M32 + 1x M20 + 1x M12
 Kabel: aan te sluiten op klemmenblok 16qmm
 Uitgangen:
 2x CEE-contactdoos 16A 5p 400V IP44 sch
 bev. met 2x automaat 16A C 3p

**Bestell-Nr. K13210052**

Afmetingen: 260 x 230 x 145mm (HxBxD)
 Ingang bovenzijde: 2x M32 + 1x M20 + 1x M12
 Ingang onderzijde: 2x M32 + 1x M20 + 1x M12
 Kabel: aan te sluiten op klemmenblok 16qmm
 Uitgangen:
 2x CEE-contactdoos 16A 5p 400V IP44 sch
 bev. met 2x automaat 16A C 3p
 Alles beveiligd met de volgende aardlek's
 1x aardlek 40A 0.03A 4p

**Bestell-Nr. K13210053**

Afmetingen: 260 x 230 x 145mm (HxBxD)
 Ingang bovenzijde: 2x M32 + 1x M20 + 1x M12
 Ingang onderzijde: 2x M32 + 1x M20 + 1x M12
 Kabel: aan te sluiten op klemmenblok 16qmm
 Uitgangen:
 2x Schuko IP44
 2x CEE-contactdoos 16A 5p 400V IP44 sch

**Bestell-Nr. K13210056**

Afmetingen: 260 x 230 x 145mm (HxBxD)
 Ingang bovenzijde: 2x M32 + 1x M20 + 1x M12
 Ingang onderzijde: 2x M32 + 1x M20 + 1x M12
 Kabel: aan te sluiten op klemmenblok 16qmm
 Uitgangen:
 1x CEE-contactdoos 16A 5p 400V IP44 sch
 bev. met 1x automaat 16A C 3p
 1x CEE-contactdoos 32A 5p 400V IP44 sch
 bev. met 1x automaat 32A C 3p



Technische informatie - compleet bedraad, gereed voor installatie
 - beschermingsgraad IP44
 - alle verdelers conform NEN-EN-IEC 61439

Bestell-Nr. K13210057

Afmetingen: 260 x 230 x 145mm (HxBxD)
 Ingang bovenzijde: 2x M32 + 1x M20 + 1x M12
 Ingang onderzijde: 2x M32 + 1x M20 + 1x M12
 Kabel: aan te sluiten op klemmenblok 16qmm
 Rdf: 0,71
 I Nom.: 40A
 Uitgangen:
 1x CEE-contactdoos 16A 5p 400V IP44 sch bev. met 1x automaat 16A C 3p
 1x CEE-contactdoos 32A 5p 400V IP44 sch bev. met 1x automaat 32A C 3p
 Alles beveiligd met de volgende aardlek's
 1x aardlek 40A 0.03A 4p

**Bestell-Nr. K13210058**

Afmetingen: 260 x 230 x 145mm (HxBxD)
 Ingang bovenzijde: 2x M32 + 1x M20 + 1x M12
 Ingang onderzijde: 2x M32 + 1x M20 + 1x M12
 Kabel: aan te sluiten op klemmenblok 16qmm
 Uitgangen:
 2x Schuko IP44
 1x CEE-contactdoos 16A 5p 400V IP44 sch
 1x CEE-contactdoos 32A 5p 400V IP44 sch

**Bestell-Nr. K13210061**

Afmetingen: 260 x 230 x 145mm (HxBxD)
 Ingang bovenzijde: 2x M32 + 1x M20 + 1x M12
 Ingang onderzijde: 2x M32 + 1x M20 + 1x M12
 Kabel: aan te sluiten op klemmenblok 16qmm
 Rdf: 0,72
 I Nom.: 63A
 Uitgangen:
 2x CEE-contactdoos 32A 5p 400V IP44 sch bev. met 2x automaat 32A C 3p

**Bestell-Nr. K13210062**

Afmetingen: 260 x 230 x 145mm (HxBxD)
 Ingang bovenzijde: 2x M32 + 1x M20 + 1x M12
 Ingang onderzijde: 2x M32 + 1x M20 + 1x M12
 Kabel: aan te sluiten op klemmenblok 16qmm
 Uitgangen:
 2x CEE-contactdoos 32A 5p 400V IP44 sch bev. met 2x automaat 32A C 3p
 Alles beveiligd met de volgende aardlek's
 1x aardlek 63A 0.03A 4p

**Bestell-Nr. K12210571**

Afmetingen: 260 x 230 x 145mm (HxBxD)
 Ingang bovenzijde: 2x M25 + 1x M20 + 1x M12
 Ingang onderzijde: 2x M25 + 1x M20 + 1x M12
 Kabel: aan te sluiten op klemmenblok 16qmm
 Rdf: 0,85
 I Nom.: 40A
 Uitgangen:
 2x Schuko IP44
 bev. met 2x aardlekautomaat 16A C 0,03A 2p
 1x CEE-contactdoos 32A 5p 400V IP44 sch bev. met 1x aardlekautomaat 32A C 0,03A 4p



Technische informatie - compleet bedraad, gereed voor installatie
 - beschermingsgraad IP44
 - alle verdelers conform NEN-EN-IEC 61439

VARIABOX

- Direct aansluitbaar
- Bescherming klasse IP44

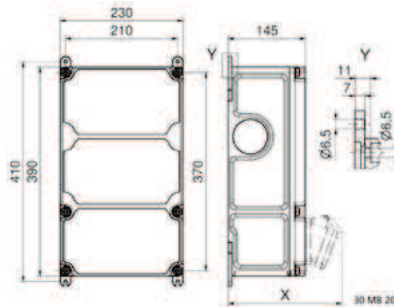

Bezeichnung/ with	IP44	IP67
OTC Klapprel OTC opening module	180	180
Schutz Steckdosensysteme socket	162	205
CEE 16A 3p	200	200
CEE 16A 4p	204	202
CEE 16A 5p	207	205
CEE 32A 3p/1p	211	213
CEE 32A 5p	213	214
CEE 63A 3p/1p/1p	229	231

Bestell-Nr. K12310550

Afmetingen: 390 x 230 x 145mm (HxBxD)
 Ingang bovenzijde: 2x M32 + 1x M20 + 1x M12
 Ingang onderzijde: 2x M32 + 1x M20 + 1x M12
 Kabel: aan te sluiten op klemmenblok 16qmm
 Rdf: 0,77
 I Nom.: 40A
 Uitgangen:
 2x CEE-contactdoos 16A 5p 400V IP44 sch
 bev. met 2x automaat 16A C 3p+Na
 Alles beveiligd met de volgende aardlek's
 1x aardlek 40A 0.03A 4p



Bestell-Nr. K12310551

Afmetingen: 390 x 230 x 145mm (HxBxD)
 Ingang bovenzijde: 2x M32 + 1x M20 + 1x M12
 Ingang onderzijde: 2x M32 + 1x M20 + 1x M12
 Kabel: aan te sluiten op klemmenblok 16qmm
 Rdf: 1
 I Nom.: 40A
 Uitgangen:
 1x CEE-contactdoos 16A 5p 400V IP44 sch
 bev. met 1x automaat 16A C 3p+Na 10
 1x CEE-contactdoos 32A 5p 400V IP44 sch
 bev. met 1x automaat 32A C 3p+Na 10
 Alles beveiligd met de volgende aardlek's
 1x aardlek 40A 0.03A 4p



Bestell-Nr. K12310552

Afmetingen: 390 x 230 x 145mm (HxBxD)
 Ingang bovenzijde: 2x M32 + 1x M20 + 1x M12
 Ingang onderzijde: 2x M32 + 1x M20 + 1x M12
 Kabel: aan te sluiten op klemmenblok 16qmm
 Rdf: 0,63
 I Nom.: 63A
 Uitgangen:
 2x CEE-contactdoos 32A 5p 400V IP44 sch
 bev. met 2x automaat 32A C 3p+Na 10
 Alles beveiligd met de volgende aardlek's
 1x aardlek 63A 0.03A 4p



Bestell-Nr. K12310553

Afmetingen: 390 x 230 x 145mm (HxBxD)
 Ingang bovenzijde: 2x M32 + 1x M20 + 1x M12
 Ingang onderzijde: 2x M32 + 1x M20 + 1x M12
 Kabel: aan te sluiten op klemmenblok 16qmm
 Rdf: 0,70
 I Nom.: 40A
 Uitgangen:
 2x Schuko IP44
 bev. met 2x automaat 16A C 1p+Na
 2x CEE-contactdoos 16A 5p 400V IP44 sch
 bev. met 2x automaat 16A C 3p+Na



Bestell-Nr. K12310554

Afmetingen: 390 x 230 x 145mm (HxBxD)
 Ingang bovenzijde: 2x M32 + 1x M20 + 1x M12
 Ingang onderzijde: 2x M32 + 1x M20 + 1x M12
 Kabel: aan te sluiten op klemmenblok 16qmm
 Rdf: 0,73
 I Nom.: 40A
 Uitgangen:
 3x Schuko IP44
 bev. met 1x automaat 16A C 1p+Na
 2x CEE-contactdoos 16A 5p 400V IP44 sch
 bev. met 2x automaat 16A C 3p+Na



Bestell-Nr. K12310555

Afmetingen: 390 x 230 x 145mm (HxBxD)
 Ingang bovenzijde: 2x M32 + 1x M20 + 1x M12
 Ingang onderzijde: 2x M32 + 1x M20 + 1x M12
 Kabel: aan te sluiten op klemmenblok 16qmm
 Rdf: 0,65
 I Nom.: 63A
 Uitgangen:
 2x Schuko IP44
 bev. met 2x automaat 16A C 1p+Na
 1x CEE-contactdoos 16A 5p 400V IP44 sch
 bev. met 1x automaat 16A C 3p+Na
 1x CEE-contactdoos 32A 5p 400V IP44 sch
 bev. met 1x automaat 32A C 3p+Na 10



Technische informatie - compleet bedraad, gereed voor installatie
- beschermingsgraad IP44
- alle verdelers conform NEN-EN-IEC 61439

Bestell-Nr. K12310556

Afmetingen: 390 x 230 x 145mm (HxBxD)
Ingang bovenzijde: 2x M32 + 1x M20 + 1x M12
Ingang onderzijde: 2x M32 + 1x M20 + 1x M12
Kabel: aan te sluiten op klemmenblok 16qmm
Rdf: 1
I Nom.: 32A
Uitgangen:
3x Schuko IP44
bev. met 1x automaat 16A C 1p+Na
1x CEE-contactdoos 16A 5p 400V IP44 sch
bev. met 1x automaat 16A C 3p+Na
1x CEE-contactdoos 32A 5p 400V IP44 sch
Alles beveiligd met de volgende aardlek's
1x aardlek 40A 0.03A 4p



Bestell-Nr. K12310557

Afmetingen: 390 x 230 x 145mm (HxBxD)
Ingang bovenzijde: 2x M32 + 1x M20 + 1x M12
Ingang onderzijde: 2x M32 + 1x M20 + 1x M12
Kabel: aan te sluiten op klemmenblok 16qmm
Rdf: 0,60
I Nom.: 63A
Uitgangen:
2x Schuko IP44
bev. met 2x automaat 16A C 1p+Na
2x CEE-contactdoos 32A 5p 400V IP44 sch
bev. met 2x automaat 32A C 3p+Na 10



Bestell-Nr. K12310558

Afmetingen: 390 x 230 x 145mm (HxBxD)
Ingang bovenzijde: 2x M32 + 1x M20 + 1x M12
Ingang onderzijde: 2x M32 + 1x M20 + 1x M12
Kabel: aan te sluiten op klemmenblok 16qmm
Rdf: 0,62
I Nom.: 63A
Uitgangen:
3x Schuko IP44
bev. met 1x automaat 16A C 1p+Na
2x CEE-contactdoos 32A 5p 400V IP44 sch
bev. met 2x automaat 32A C 3p+Na 10



Bestell-Nr. K12310575

Afmetingen: 390 x 230 x 145mm (HxBxD)
Ingang bovenzijde: 2x M32 + 1x M20 + 1x M12
Ingang onderzijde: 2x M32 + 1x M20 + 1x M12
Kabel: aan te sluiten op klemmenblok 16qmm
Rdf: 0,86
I Nom.: 40A
Uitgangen:
3x Schuko IP44
bev. met 1x aardlekautomaat 16A C 0,03A 2p
2x CEE-contactdoos 16A 5p 400V IP44 sch
bev. met 2x aardlekautomaat 16A C 0,03A 4p



Bestell-Nr. K12310576

Afmetingen: 390 x 230 x 145mm (HxBxD)
Ingang bovenzijde: 2x M32 + 1x M20 + 1x M12
Ingang onderzijde: 2x M32 + 1x M20 + 1x M12
Kabel: aan te sluiten op klemmenblok 16qmm
Rdf: 0,70
I Nom.: 63A
Uitgangen:
3x Schuko IP44
bev. met 1x aardlekautomaat 16A C 0,03A 2p
1x CEE-contactdoos 16A 5p 400V IP44 sch
bev. met 1x aardlekautomaat 16A C 0,03A 4p
1x CEE-contactdoos 32A 5p 400V IP44 sch
bev. met 1x aardlekautomaat 32A C 0,03A 4p



Bestell-Nr. K12310577

Afmetingen: 390 x 230 x 145mm (HxBxD)
Ingang bovenzijde: 2x M32 + 1x M20 + 1x M12
Ingang onderzijde: 2x M32 + 1x M20 + 1x M12
Kabel: aan te sluiten op klemmenblok 16qmm
Rdf: 0,61
I Nom.: 63A
Uitgangen:
3x Schuko IP44
bev. met 1x aardlekautomaat 16A C 0,03A 2p
2x CEE-contactdoos 32A 5p 400V IP44 sch
bev. met 2x aardlekautomaat 32A C 0,03A 4p



Bestell-Nr. K13310067

Afmetingen: 390 x 230 x 145mm (HxBxD)
Ingang bovenzijde: 2x M32 + 1x M20 + 1x M12
Ingang onderzijde: 2x M32 + 1x M20 + 1x M12
Kabel: aan te sluiten op klemmenblok 16qmm
Uitgangen:
4x Schuko IP44
bev. met 4x automaat 16A C 1p
1x CEE-contactdoos 16A 5p 400V IP44
bev. met 1x automaat 16A C 3p
Alles beveiligd met de volgende aardlek's
1x aardlek 40A 0.03A 4p



Bestell-Nr. K13310071

Afmetingen: 390 x 230 x 145mm (HxBxD)
Ingang bovenzijde: 2x M32 + 1x M20 + 1x M12
Ingang onderzijde: 2x M32 + 1x M20 + 1x M12
Kabel: aan te sluiten op klemmenblok 16qmm
Uitgangen:
2x Schuko IP44
bev. met 2x automaat 16A C 1p
2x CEE-contactdoos 16A 5p 400V IP44 sch
bev. met 2x automaat 16A C 3p



Technische informatie - compleet bedraad, gereed voor installatie
 - beschermingsgraad IP44
 - alle verdelers conform NEN-EN-IEC 61439

Bestell-Nr. K13310072

Afmetingen: 390 x 230 x 145mm (HxBxD)
 Ingang bovenzijde: 2x M32 + 1x M20 + 1x M12
 Kabel: aan te sluiten op klemmenblok 16qmm
 Uitgangen:
 2x Schuko IP44
 bev. met 2x automaat 16A C 1p
 2x CEE-contactdoos 16A 5p 400V IP44 sch
 bev. met 2x automaat 16A C 3p
 Alles beveiligd met de volgende aardlek's
 1x aardlek 40A 0.03A 4p

**Bestell-Nr. K13310074**

Afmetingen: 390 x 230 x 145mm (HxBxD)
 Ingang bovenzijde: 2x M32 + 1x M20 + 1x M12
 Kabel: aan te sluiten op klemmenblok 16qmm
 Uitgangen:
 3x Schuko IP44
 bev. met 3x automaat 16A C 1p
 2x CEE-contactdoos 16A 5p 400V IP44 sch
 bev. met 2x automaat 16A C 3p

**Bestell-Nr. K13310077**

Afmetingen: 390 x 230 x 145mm (HxBxD)
 Ingang bovenzijde: 2x M32 + 1x M20 + 1x M12
 Kabel: aan te sluiten op klemmenblok 16qmm
 Uitgangen:
 2x Schuko IP44
 bev. met 2x automaat 16A C 1p
 1x CEE-contactdoos 16A 5p 400V IP44 sch
 bev. met 1x automaat 16A C 3p
 1x CEE-contactdoos 32A 5p 400V IP44 sch

**Bestell-Nr. K13310078**

Afmetingen: 390 x 230 x 145mm (HxBxD)
 Ingang bovenzijde: 2x M32 + 1x M20 + 1x M12
 Kabel: aan te sluiten op klemmenblok 16qmm
 Uitgangen:
 2x Schuko IP44
 bev. met 2x automaat 16A C 1p
 1x CEE-contactdoos 16A 5p 400V IP44 sch
 bev. met 1x automaat 16A C 3p
 1x CEE-contactdoos 32A 5p 400V IP44 sch
 bev. met 1x automaat 32A C 3p

**Bestell-Nr. K13310080**

Afmetingen: 390 x 230 x 145mm (HxBxD)
 Ingang bovenzijde: 2x M32 + 1x M20 + 1x M12
 Kabel: aan te sluiten op klemmenblok 16qmm
 Uitgangen:
 2x Schuko IP44
 bev. met 2x automaat 16A C 1p
 1x CEE-contactdoos 16A 5p 400V IP44 sch
 bev. met 1x automaat 16A C 3p
 1x CEE-contactdoos 32A 5p 400V IP44 sch
 Alles beveiligd met de volgende aardlek's
 1x aardlek 40A 0.03A 4p

**Bestell-Nr. K13310081**

Afmetingen: 390 x 230 x 145mm (HxBxD)
 Ingang bovenzijde: 2x M32 + 1x M20 + 1x M12
 Kabel: aan te sluiten op klemmenblok 16qmm
 Uitgangen:
 2x Schuko IP44
 bev. met 2x automaat 16A C 1p
 1x CEE-contactdoos 16A 5p 400V IP44 sch
 bev. met 1x automaat 16A C 3p
 1x CEE-contactdoos 32A 5p 400V IP44 sch
 bev. met 1x automaat 32A C 3p
 Alles beveiligd met de volgende aardlek's
 1x aardlek 40A 0.03A 4p

**Bestell-Nr. K13310082**

Afmetingen: 390 x 230 x 145mm (HxBxD)
 Ingang bovenzijde: 2x M32 + 1x M20 + 1x M12
 Kabel: aan te sluiten op klemmenblok 16qmm
 Uitgangen:
 2x Schuko IP44
 bev. met 2x automaat 16A C 1p
 1x CEE-contactdoos 16A 5p 400V IP44 sch
 bev. met 1x automaat 16A C 3p
 1x CEE-contactdoos 32A 5p 400V IP44 sch
 bev. met 1x automaat 32A C 3p
 Alles beveiligd met de volgende aardlek's
 1x aardlek 63A 0.03A 4p

**Bestell-Nr. K13310084**

Afmetingen: 390 x 230 x 145mm (HxBxD)
 Ingang bovenzijde: 2x M32 + 1x M20 + 1x M12
 Kabel: aan te sluiten op klemmenblok 16qmm
 Uitgangen:
 3x Schuko IP44
 bev. met 3x automaat 16A C 1p
 1x CEE-contactdoos 16A 5p 400V IP44 sch
 bev. met 1x automaat 16A C 3p
 1x CEE-contactdoos 32A 5p 400V IP44 sch



Technische informatie - compleet bedraad, gereed voor installatie
 - beschermingsgraad IP44
 - alle verdelers conform NEN-EN-IEC 61439

Bestell-Nr. K13310085

Afmetingen: 390 x 230 x 145mm (HxBxD)
 Ingang bovenzijde: 2x M40 + 1x M20 + 1x M12
 Ingang onderzijde: 2x M40 + 1x M20 + 1x M12
 Kabel: aan te sluiten op klemmenblok 16qmm
 Uitgangen:
 3x Schuko IP44
 bev. met 3x automaat 16A C 1p
 1x CEE-contactdoos 16A 5p 400V IP44 sch
 bev. met 1x automaat 16A C 3p
 1x CEE-contactdoos 32A 5p 400V IP44 sch
 bev. met 1x automaat 32A C 3p

**Bestell-Nr. K13310086**

Afmetingen: 390 x 230 x 145mm (HxBxD)
 Ingang bovenzijde: 2x M32 + 1x M20 + 1x M12
 Ingang onderzijde: 2x M32 + 1x M20 + 1x M12
 Kabel: aan te sluiten op klemmenblok 16qmm
 Uitgangen:
 3x Schuko IP44
 bev. met 3x automaat 16A C 1p
 1x CEE-contactdoos 16A 5p 400V IP44 sch
 bev. met 1x automaat 16A C 3p
 1x CEE-contactdoos 32A 5p 400V IP44 sch
 Alles beveiligd met de volgende aardlek's
 1x aardlek 40A 0.03A 4p

**Bestell-Nr. K13310087**

Afmetingen: 390 x 230 x 145mm (HxBxD)
 Ingang bovenzijde: 2x M32 + 1x M20 + 1x M12
 Ingang onderzijde: 2x M32 + 1x M20 + 1x M12
 Kabel: aan te sluiten op klemmenblok 16qmm
 Rdf: 0,68
 I Nom.: 63A
 Uitgangen:
 4x Schuko IP44
 bev. met 4x automaat 16A C 1p
 1x CEE-contactdoos 16A 5p 400V IP44 sch
 bev. met 1x automaat 16A C 3p
 1x CEE-contactdoos 32A 5p 400V IP44 sch
 bev. met 1x automaat 32A C 3p

**Bestell-Nr. K13310089**

Afmetingen: 390 x 230 x 145mm (HxBxD)
 Ingang bovenzijde: 2x M32 + 1x M20 + 1x M12
 Ingang onderzijde: 2x M32 + 1x M20 + 1x M12
 Kabel: aan te sluiten op klemmenblok 16qmm
 Uitgangen:
 2x Schuko IP44
 bev. met 2x automaat 16A C 1p
 2x CEE-contactdoos 32A 5p 400V IP44 sch
 bev. met 2x automaat 32A C 3p

**Bestell-Nr. K13310090**

Afmetingen: 390 x 230 x 145mm (HxBxD)
 Ingang bovenzijde: 2x M32 + 1x M20 + 1x M12
 Ingang onderzijde: 2x M32 + 1x M20 + 1x M12
 Kabel: aan te sluiten op klemmenblok 16qmm
 Uitgangen:
 3x Schuko IP44
 bev. met 3x automaat 16A C 1p
 2x CEE-contactdoos 32A 5p 400V IP44 sch
 bev. met 2x automaat 32A C 3p

**Bestell-Nr. K13310092**

Afmetingen: 390 x 230 x 145mm (HxBxD)
 Ingang bovenzijde: 2x M40 + 1x M20 + 1x M12
 Ingang onderzijde: 2x M40 + 1x M20 + 1x M12
 Kabel: aan te sluiten op klemmenblok 25qmm
 Uitgangen:
 2x Schuko IP44
 bev. met 2x automaat 16A C 1p
 1x CEE-contactdoos 63A 5p 400V IP67 sch
 bev. met 1x automaat 63A C 3p

**Bestell-Nr. K13310093**

Afmetingen: 390 x 230 x 145mm (HxBxD)
 Ingang bovenzijde: 2x M40 + 1x M20 + 1x M12
 Ingang onderzijde: 2x M40 + 1x M20 + 1x M12
 Kabel: aan te sluiten op klemmenblok 16qmm
 Uitgangen:
 2x Schuko IP44
 bev. met 2x automaat 16A C 1p
 1x CEE-contactdoos 16A 5p 400V IP44 sch
 bev. met 1x automaat 16A C 3p
 1x CEE-contactdoos 63A 5p 400V IP67 sch
 Alles beveiligd met de volgende aardlek's
 1x aardlek 63A 0.03A 4p

**Bestell-Nr. K13310094**

Afmetingen: 390 x 230 x 145mm (HxBxD)
 Ingang bovenzijde: 2x M40 + 1x M20 + 1x M12
 Ingang onderzijde: 2x M40 + 1x M20 + 1x M12
 Kabel: aan te sluiten op klemmenblok 16qmm
 Uitgangen:
 2x Schuko IP44
 bev. met 2x automaat 16A C 1p
 1x CEE-contactdoos 32A 5p 400V IP44 sch
 bev. met 1x automaat 32A C 3p
 1x CEE-contactdoos 63A 5p 400V IP67 sch
 Alles beveiligd met de volgende aardlek's
 1x aardlek 63A 0.03A 4p



Technische informatie - compleet bedraad, gereed voor installatie
- beschermingsgraad IP44
- alle verdelers conform NEN-EN-IEC 61439

Bestell-Nr. K13310096

Afmetingen: 390 x 230 x 145mm (HxBxD)

Ingang bovenzijde: 2x M40 + 1x M20 + 1x M12

Ingang onderzijde: 2x M40 + 1x M20 + 1x M12

Kabel: aan te sluiten op klemmenblok 16qmm

Uitgangen:

1x CEE-contactdoos 16A 5p 400V IP44 sch
bev. met 1x automaat 16A C 3p

1x CEE-contactdoos 32A 5p 400V IP44 sch
bev. met 1x automaat 32A C 3p

1x CEE-contactdoos 63A 5p 400V IP67 sch

Alles beveiligd met de volgende aardlek's

1x aardlek 63A 0.03A 4p



Technische informatie - compleet bedraad, gereed voor installatie
- beschermingsgraad IP44
- alle verdelers conform NEN-EN-IEC 61439

VARIABOX

- Direct aansluitbaar
- Bescherming klasse IP44

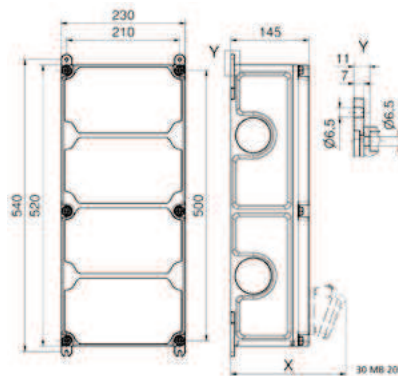

Tiefenmaß/ depth X (mm)		
Bezeichnung/ with	IP44	IP67
OTC-Klappel/ OTC opening window	180	180
Schutz- Steckbohrdiameter socket	162	205
CEE 16A 3p	200	200
CEE 16A 4p	204	202
CEE 16A 5p	207	205
CEE 32A 3p+Na	211	213
CEE 32A 5p	213	214
CEE 63A 3p+Na/5p	229	331

Bestell-Nr. K12410559

Afmetingen: 520 x 230 x 145mm (HxBxD)
Ingang bovenzijde: 2x M32 + 1x M20 + 1x M12
Ingang onderzijde: 2x M32 + 1x M20 + 1x M12
Kabel: aan te sluiten op klemmenblok 16qmm
Rdf: 0,63
I Nom.: 63A
Uitgangen:
2x Schuko IP44
bev. met 1x automaat 16A C 1p+Na
2x CEE-contactdoos 16A 5p 400V IP44 sch
bev. met 2x automaat 16A C 3p+Na
1x CEE-contactdoos 32A 5p 400V IP44 sch
bev. met 1x automaat 32A C 3p+Na 10
Alles beveiligd met de volgende aardlek's
1x aardlek 63A 0.03A 4p



Bestell-Nr. K12410560

Afmetingen: 520 x 230 x 145mm (HxBxD)
Ingang bovenzijde: 2x M32 + 1x M20 + 1x M12
Ingang onderzijde: 2x M32 + 1x M20 + 1x M12
Kabel: aan te sluiten op klemmenblok 16qmm
Rdf: 0,69
I Nom.: 40A
Uitgangen:
3x Schuko IP44
bev. met 3x automaat 16A C 1p+Na
2x CEE-contactdoos 16A 5p 400V IP44 sch
bev. met 2x automaat 16A C 3p+Na
Alles beveiligd met de volgende aardlek's
1x aardlek 40A 0.03A 4p
1x aardlek 25A 0.03A 2p



Bestell-Nr. K12410561

Afmetingen: 520 x 230 x 145mm (HxBxD)
Ingang bovenzijde: 2x M32 + 1x M20 + 1x M12
Ingang onderzijde: 2x M32 + 1x M20 + 1x M12
Kabel: aan te sluiten op klemmenblok 16qmm
Rdf: 0,61
I Nom.: 63A
Uitgangen:
3x Schuko IP44
bev. met 1x automaat 16A C 1p+Na
2x CEE-contactdoos 32A 5p 400V IP44 sch
bev. met 2x automaat 32A C 3p+Na 10
Alles beveiligd met de volgende aardlek's
1x aardlek 63A 0.03A 4p



Bestell-Nr. K12410562

Afmetingen: 520 x 230 x 145mm (HxBxD)
Ingang bovenzijde: 2x M32 + 1x M20 + 1x M12
Ingang onderzijde: 2x M32 + 1x M20 + 1x M12
Kabel: aan te sluiten op klemmenblok 16qmm
Rdf: 0,64
I Nom.: 63A
Uitgangen:
3x Schuko IP44
bev. met 1x automaat 16A C 1p+Na
1x CEE-contactdoos 16A 5p 400V IP44 sch
bev. met 1x automaat 16A C 3p+Na
1x CEE-contactdoos 32A 5p 400V IP44 sch
bev. met 1x automaat 32A C 3p+Na 10
Alles beveiligd met de volgende aardlek's
1x aardlek 63A 0.03A 4p



Bestell-Nr. K12410563

Afmetingen: 520 x 230 x 145mm (HxBxD)
Ingang bovenzijde: 2x M32 + 1x M20 + 1x M12
Ingang onderzijde: 2x M32 + 1x M20 + 1x M12
Kabel: aan te sluiten op klemmenblok 16qmm
Rdf: 0,74
I Nom.: 40A
Uitgangen:
2x Schuko IP44
bev. met 2x automaat 16A C 1p+Na
2x CEE-contactdoos 16A 5p 400V IP44 sch
bev. met 2x automaat 16A C 3p+Na
Alles beveiligd met de volgende aardlek's
1x aardlek 40A 0.03A 4p



Bestell-Nr. K12410564

Afmetingen: 520 x 230 x 145mm (HxBxD)
Ingang bovenzijde: 2x M32 + 1x M20 + 1x M12
Ingang onderzijde: 2x M32 + 1x M20 + 1x M12
Kabel: aan te sluiten op klemmenblok 16qmm
Rdf: 0,69
I Nom.: 40A
Uitgangen:
3x Schuko IP44
bev. met 1x automaat 16A C 1p+Na
2x CEE-contactdoos 16A 5p 400V IP44 sch
bev. met 2x automaat 16A C 3p+Na
Alles beveiligd met de volgende aardlek's
1x aardlek 40A 0.03A 4p



Technische informatie - compleet bedraad, gereed voor installatie
 - beschermingsgraad IP44
 - alle verdelers conform NEN-EN-IEC 61439

Bestell-Nr. K12410565

Afmetingen: 520 x 230 x 145mm (HxBxD)
 Ingang bovenzijde: 2x M32 + 1x M20 + 1x M12
 Ingang onderzijde: 2x M32 + 1x M20 + 1x M12
 Kabel: aan te sluiten op klemmenblok 16qmm
 Rdf: 0,73
 I Nom.: 63A
 Uitgangen:
 2x Schuko IP44
 bev. met 2x automaat 16A C 1p
 1x CEE-contactdoos 16A 5p 400V IP44 sch
 bev. met 1x automaat 16A C 3p+Na
 1x CEE-contactdoos 32A 5p 400V IP44 sch
 bev. met 1x automaat 32A C 3p+Na 10
 Alles beveiligd met de volgende aardlek's
 1x aardlek 63A 0.03A 4p

**Bestell-Nr. K12410566**

Afmetingen: 520 x 230 x 145mm (HxBxD)
 Ingang bovenzijde: 2x M32 + 1x M20 + 1x M12
 Ingang onderzijde: 2x M32 + 1x M20 + 1x M12
 Kabel: aan te sluiten op klemmenblok 16qmm
 Rdf: 0,64
 I Nom.: 63A
 Uitgangen:
 2x Schuko IP44
 bev. met 2x automaat 16A C 1p+Na
 2x CEE-contactdoos 32A 5p 400V IP44 sch
 bev. met 2x automaat 32A C 3p+Na 10
 Alles beveiligd met de volgende aardlek's
 1x aardlek 63A 0.03A 4p

**Bestell-Nr. K12410567**

Afmetingen: 520 x 230 x 145mm (HxBxD)
 Ingang bovenzijde: 2x M32 + 1x M20 + 1x M12
 Ingang onderzijde: 2x M32 + 1x M20 + 1x M12
 Kabel: aan te sluiten op klemmenblok 16qmm
 Rdf: 0,61
 I Nom.: 63A
 Uitgangen:
 3x Schuko IP44
 bev. met 1x automaat 16A C 1p+Na
 2x CEE-contactdoos 32A 5p 400V IP44 sch
 bev. met 2x automaat 32A C 3p+Na 10
 Alles beveiligd met de volgende aardlek's
 1x aardlek 63A 0.03A 4p

**Bestell-Nr. K13410098**

Afmetingen: 520 x 230 x 145mm (HxBxD)
 Ingang bovenzijde: 2x M32 + 1x M20 + 1x M12
 Ingang onderzijde: 2x M32 + 1x M20 + 1x M12
 Kabel: aan te sluiten op klemmenblok 16qmm
 Uitgangen:
 3x Schuko IP44
 bev. met 3x automaat 16A C 1p
 2x CEE-contactdoos 16A 5p 400V IP44 sch
 bev. met 2x automaat 16A C 3p
 Alles beveiligd met de volgende aardlek's
 1x aardlek 40A 0.03A 4p

**Bestell-Nr. K13410100**

Afmetingen: 520 x 230 x 145mm (HxBxD)
 Ingang bovenzijde: 2x M32 + 1x M20 + 1x M12
 Ingang onderzijde: 2x M32 + 1x M20 + 1x M12
 Kabel: aan te sluiten op klemmenblok 16qmm
 Uitgangen:
 4x Schuko IP44
 bev. met 4x automaat 16A C 1p
 2x CEE-contactdoos 16A 5p 400V IP44 sch
 bev. met 2x automaat 16A C 3p
 Alles beveiligd met de volgende aardlek's
 1x aardlek 40A 0.03A 4p

**Bestell-Nr. K13410102**

Afmetingen: 520 x 230 x 145mm (HxBxD)
 Ingang bovenzijde: 2x M32 + 1x M20 + 1x M12
 Ingang onderzijde: 2x M32 + 1x M20 + 1x M12
 Kabel: aan te sluiten op klemmenblok 16qmm
 In: 63A
 Uitgangen:
 3x Schuko IP44
 bev. met 3x automaat 16A C 1p
 2x CEE-contactdoos 32A 5p 400V IP44 sch
 bev. met 2x automaat 32A C 3p
 Alles beveiligd met de volgende aardlek's
 1x aardlek 63A 0.03A 4p

**Bestell-Nr. K13410103**

Afmetingen: 520 x 230 x 145mm (HxBxD)
 Ingang bovenzijde: 2x M32 + 1x M20 + 1x M12
 Ingang onderzijde: 2x M32 + 1x M20 + 1x M12
 Kabel: aan te sluiten op klemmenblok 16qmm
 Uitgangen:
 2x Schuko IP44
 bev. met 2x automaat 16A C 1p
 3x CEE-contactdoos 16A 5p 400V IP44 sch
 bev. met 3x automaat 16A C 3p
 Alles beveiligd met de volgende aardlek's
 1x aardlek 63A 0.03A 4p

**Bestell-Nr. K13410104**

Afmetingen: 520 x 230 x 145mm (HxBxD)
 Ingang bovenzijde: 2x M32 + 1x M20 + 1x M12
 Ingang onderzijde: 2x M32 + 1x M20 + 1x M12
 Kabel: aan te sluiten op klemmenblok 16qmm
 Rdf: 0,65
 I Nom.: 63A
 Uitgangen:
 4x Schuko IP44
 bev. met 4x automaat 16A C 1p
 3x CEE-contactdoos 16A 5p 400V IP44
 bev. met 3x automaat 16A C 3p



Technische informatie - compleet bedraad, gereed voor installatie
 - beschermingsgraad IP44
 - alle verdelers conform NEN-EN-IEC 61439

Bestell-Nr. K13410110

Afmetingen: 520 x 230 x 145mm (HxBxD)
 Ingang bovenzijde: 2x M32 + 1x M20 + 1x M12
 Ingang onderzijde: 2x M32 + 1x M20 + 1x M12
 Kabel: aan te sluiten op klemmenblok 16qmm
 Uitgangen:
 3x Schuko IP44
 bev. met 3x automaat 16A C 1p
 1x CEE-contactdoos 16A 5p 400V IP44 sch
 bev. met 1x automaat 16A C 3p
 1x CEE-contactdoos 32A 5p 400V IP44 sch
 bev. met 1x automaat 32A C 3p
 Alles beveiligd met de volgende aardlek's
 1x aardlek 40A 0.03A 4p

**Bestell-Nr. K13410111**

Afmetingen: 520 x 230 x 145mm (HxBxD)
 Ingang bovenzijde: 2x M32 + 1x M20 + 1x M12
 Ingang onderzijde: 2x M32 + 1x M20 + 1x M12
 Kabel: aan te sluiten op klemmenblok 16qmm
 Uitgangen:
 3x Schuko IP44
 bev. met 3x automaat 16A C 1p
 1x CEE-contactdoos 16A 5p 400V IP44 sch
 bev. met 1x automaat 16A C 3p
 1x CEE-contactdoos 32A 5p 400V IP44 sch
 bev. met 1x automaat 32A C 3p
 Alles beveiligd met de volgende aardlek's
 1x aardlek 63A 0.03A 4p

**Bestell-Nr. K13410112**

Afmetingen: 520 x 230 x 145mm (HxBxD)
 Ingang bovenzijde: 2x M32 + 1x M20 + 1x M12
 Ingang onderzijde: 2x M32 + 1x M20 + 1x M12
 Kabel: aan te sluiten op klemmenblok 16qmm
 Rdf: 0,69
 I Nom.: 63A
 Uitgangen:
 4x Schuko IP44
 bev. met 4x automaat 16A C 1p
 1x CEE-contactdoos 16A 5p 400V IP44 sch
 bev. met 1x automaat 16A C 3p+Na
 1x CEE-contactdoos 32A 5p 400V IP44 sch
 bev. met 1x automaat 32A C 3p+Na 10
 Alles beveiligd met de volgende aardlek's
 1x aardlek 63A 0.03A 4p

**Bestell-Nr. K13410114**

Afmetingen: 520 x 230 x 145mm (HxBxD)
 Ingang bovenzijde: 2x M32 + 1x M20 + 1x M12
 Ingang onderzijde: 2x M32 + 1x M20 + 1x M12
 Kabel: aan te sluiten op klemmenblok 16qmm
 Uitgangen:
 2x Schuko IP44
 bev. met 2x automaat 16A C 1p
 2x CEE-contactdoos 16A 5p 400V IP44 sch
 bev. met 2x automaat 16A C 3p
 1x CEE-contactdoos 32A 5p 400V IP44 sch
 bev. met 1x automaat 32A C 3p

**Bestell-Nr. K13410115**

Afmetingen: 520 x 230 x 145mm (HxBxD)
 Ingang bovenzijde: 2x M32 + 1x M20 + 1x M12
 Ingang onderzijde: 2x M32 + 1x M20 + 1x M12
 Kabel: aan te sluiten op klemmenblok 16qmm
 Uitgangen:
 2x Schuko IP44
 bev. met 2x automaat 16A C 1p
 2x CEE-contactdoos 16A 5p 400V IP44 sch
 bev. met 2x automaat 16A C 3p
 1x CEE-contactdoos 32A 5p 400V IP44 sch
 bev. met 1x automaat 32A C 3p
 Alles beveiligd met de volgende aardlek's
 1x aardlek 63A 0.03A 4p

**Bestell-Nr. K13410118**

Afmetingen: 520 x 230 x 145mm (HxBxD)
 Ingang bovenzijde: 2x M32 + 1x M20 + 1x M12
 Ingang onderzijde: 2x M32 + 1x M20 + 1x M12
 Kabel: aan te sluiten op klemmenblok 16qmm
 Uitgangen:
 4x Schuko IP44
 bev. met 4x automaat 16A C 1p
 1x CEE-contactdoos 16A 5p 400V IP44 sch
 bev. met 1x automaat 16A C 3p
 1x CEE-contactdoos 63A 5p 400V IP67 sch
 bev. met 1x automaat 63A C 3p

**Bestell-Nr. K13410121**

Afmetingen: 520 x 230 x 145mm (HxBxD)
 Ingang bovenzijde: 2x M32 + 1x M20 + 1x M12
 Ingang onderzijde: 2x M32 + 1x M20 + 1x M12
 Kabel: aan te sluiten op klemmenblok 16qmm
 Uitgangen:
 2x Schuko IP44
 bev. met 2x automaat 16A C 1p
 1x CEE-contactdoos 16A 5p 400V IP44 sch
 bev. met 1x automaat 16A C 3p
 1x CEE-contactdoos 32A 5p 400V IP44 sch
 bev. met 1x automaat 32A C 3p
 1x CEE-contactdoos 63A 5p 400V IP67 sch
 bev. met 1x automaat 63A C 3p

**Bestell-Nr. K13410122**

Afmetingen: 520 x 230 x 145mm (HxBxD)
 Ingang bovenzijde: 2x M40 + 1x M20 + 1x M12
 Ingang onderzijde: 2x M40 + 1x M20 + 1x M12
 Kabel: aan te sluiten op klemmenblok 16qmm
 Uitgangen:
 2x Schuko IP44
 bev. met 2x automaat 16A C 1p
 1x CEE-contactdoos 16A 5p 400V IP44 sch
 bev. met 1x automaat 16A C 3p
 1x CEE-contactdoos 32A 5p 400V IP44 sch
 bev. met 1x automaat 32A C 3p
 1x CEE-contactdoos 63A 5p 400V IP67 sch
 Alles beveiligd met de volgende aardlek's
 1x aardlek 63A 0.03A 4p



Technische informatie - compleet bedraad, gereed voor installatie
 - beschermingsgraad IP44
 - alle verdelers conform NEN-EN-IEC 61439

VARIABOX

- Direct aansluitbaar
- Bescherming klasse IP44

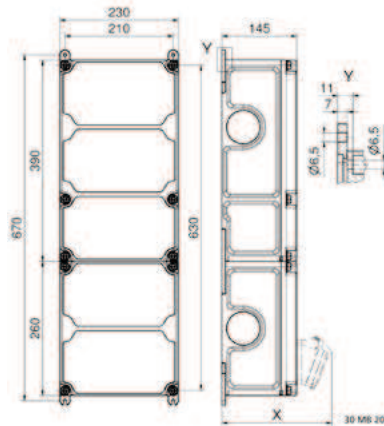

Tiefenmaß/ depth X (mm)		
Bezeichnung/ with	IP44	IP67
OTC-Klappschalter OTC operating switch	180	180
Schutz Steckdosensysteme socket	162	205
CEE 16A 3p	200	200
CEE 16A 4p	204	202
CEE 16A 5p	202	205
CEE 32A 3p/4p	211	213
CEE 32A 5p	213	214
CEE 63A 3p/4p/5p	229	231

Bestell-Nr. K13510125

Afmetingen: 650 x 230 x 145mm (HxBxD)
 Ingang bovenzijde: 2x M25 + 1x M20 + 1x M12
 Ingang onderzijde: 2x M25 + 1x M20 + 1x M12
 Kabel: aan te sluiten op klemmenblok 25qmm
 Uitgangen:
 4x Schuko IP44
 bev. met 4x automaat 16A C 1p
 3x CEE-contactdoos 16A 5p 400V IP44 sch
 bev. met 3x automaat 16A C 3p
 Alles beveiligd met de volgende aardlek's
 1x aardlek 63A 0.03A 4p



Bestell-Nr. K13510126

Afmetingen: 650 x 230 x 145mm (HxBxD)
 Ingang bovenzijde: 2x M25 + 1x M20 + 1x M12
 Ingang onderzijde: 2x M25 + 1x M20 + 1x M12
 Kabel: aan te sluiten op klemmenblok 16qmm
 Uitgangen:
 6x CEE-contactdoos 16A 3p 230V IP44 sch
 bev. met 6x automaat 16A C 1p
 Alles beveiligd met de volgende aardlek's
 6x aardlek 25A 0.03A 2p



Bestell-Nr. K13510128

Afmetingen: 650 x 230 x 145mm (HxBxD)
 Ingang bovenzijde: 2x M25 + 1x M20 + 1x M12
 Ingang onderzijde: 2x M25 + 1x M20 + 1x M12
 Kabel: aan te sluiten op klemmenblok 25qmm
 Uitgangen:
 4x Schuko IP44
 bev. met 4x automaat 16A C 1p
 3x CEE-contactdoos 32A 5p 400V IP44 sch
 bev. met 3x automaat 32A C 3p
 Alles beveiligd met de volgende aardlek's
 1x aardlek 63A 0.03A 4p



Bestell-Nr. K13510129

Afmetingen: 650 x 230 x 145mm (HxBxD)
 Ingang bovenzijde: 2x M25 + 1x M20 + 1x M12
 Ingang onderzijde: 2x M25 + 1x M20 + 1x M12
 Kabel: aan te sluiten op klemmenblok 25qmm
 Rdf: 0,80
 I Nom.: 63A
 Uitgangen:
 6x Schuko IP44
 bev. met 6x automaat 16A C 1p
 1x CEE-contactdoos 16A 5p 400V IP44 sch
 bev. met 1x automaat 16A C 3p
 1x CEE-contactdoos 32A 5p 400V IP44 sch
 bev. met 1x automaat 32A C 3p
 Alles beveiligd met de volgende aardlek's
 1x aardlek 63A 0.03A 4p



Bestell-Nr. K13510131

Afmetingen: 650 x 230 x 145mm (HxBxD)
 Ingang bovenzijde: 2x M25 + 1x M20 + 1x M12
 Ingang onderzijde: 2x M25 + 1x M20 + 1x M12
 Kabel: aan te sluiten op klemmenblok 25qmm
 Uitgangen:
 4x Schuko IP44
 bev. met 4x automaat 16A C 1p
 2x CEE-contactdoos 16A 5p 400V IP44 sch
 bev. met 2x automaat 16A C 3p
 1x CEE-contactdoos 32A 5p 400V IP44 sch
 bev. met 1x automaat 32A C 3p
 Alles beveiligd met de volgende aardlek's
 1x aardlek 63A 0.03A 4p



Bestell-Nr. K13510133

Afmetingen: 650 x 230 x 145mm (HxBxD)
 Ingang bovenzijde: 2x M25 + 1x M20 + 1x M12
 Ingang onderzijde: 2x M25 + 1x M20 + 1x M12
 Kabel: aan te sluiten op klemmenblok 25qmm
 Uitgangen:
 4x Schuko IP44
 bev. met 4x automaat 16A C 1p
 1x CEE-contactdoos 16A 5p 400V IP44 sch
 bev. met 1x automaat 16A C 3p
 2x CEE-contactdoos 32A 5p 400V IP44 sch
 bev. met 2x automaat 32A C 3p
 Alles beveiligd met de volgende aardlek's
 1x aardlek 63A 0.03A 4p



Technische informatie - compleet bedraad, gereed voor installatie
 - beschermingsgraad IP44
 - alle verdelers conform NEN-EN-IEC 61439

Bestell-Nr. K13510134

Afmetingen: 650 x 230 x 145mm (HxBxD)
 Ingang bovenzijde: 2x M25 + 1x M20 + 1x M12
 Ingang onderzijde: 2x M25 + 1x M20 + 1x M12
 Kabel: aan te sluiten op klemmenblok 16qmm
 Uitgangen:
 2x Schuko IP44
 bev. met 2x automaat 16A C 1p
 2x CEE-contactdoos 16A 5p 400V IP44 sch
 bev. met 2x automaat 16A C 3p
 2x CEE-contactdoos 32A 5p 400V IP44 sch
 bev. met 2x automaat 32A C 3p
 Alles beveiligd met de volgende aardlek's
 1x aardlek 63A 0.03A 4p

**Bestell-Nr. K13510135**

Afmetingen: 650 x 230 x 145mm (HxBxD)
 Ingang bovenzijde: 2x M40 + 1x M20 + 1x M12
 Ingang onderzijde: 2x M40 + 1x M20 + 1x M12
 Kabel: aan te sluiten op klemmenblok 16qmm
 Uitgangen:
 3x Schuko IP44
 bev. met 3x automaat 16A C 1p
 2x CEE-contactdoos 16A 5p 400V IP44 sch
 bev. met 2x automaat 16A C 3p
 2x CEE-contactdoos 32A 5p 400V IP44 sch
 bev. met 2x automaat 32A C 3p
 Alles beveiligd met de volgende aardlek's
 1x aardlek 63A 0.03A 4p

**Bestell-Nr. K13510142**

Afmetingen: 650 x 230 x 145mm (HxBxD)
 Ingang bovenzijde: 2x M40 + 1x M20 + 1x M12
 Ingang onderzijde: 2x M40 + 1x M20 + 1x M12
 Kabel: aan te sluiten op klemmenblok 25qmm
 Uitgangen:
 4x Schuko IP44
 bev. met 4x automaat 16A C 1p
 1x CEE-contactdoos 16A 5p 400V IP44 sch
 bev. met 1x automaat 16A C 3p
 1x CEE-contactdoos 32A 5p 400V IP44 sch
 bev. met 1x automaat 32A C 3p
 1x CEE-contactdoos 63A 5p 400V IP67 sch
 Alles beveiligd met de volgende aardlek's
 1x aardlek 63A 0.03A 4p

**Bestell-Nr. K13510145**

Afmetingen: 650 x 230 x 145mm (HxBxD)
 Ingang bovenzijde: 2x M25 + 1x M20 + 1x M12
 Ingang onderzijde: 2x M25 + 1x M20 + 1x M12
 Kabel: aan te sluiten op klemmenblok 25qmm
 Uitgangen:
 4x Schuko IP44
 bev. met 4x automaat 16A C 1p
 1x CEE-contactdoos 16A 5p 400V IP44 sch
 bev. met 1x automaat 16A C 3p
 1x CEE-contactdoos 32A 5p 400V IP44 sch
 bev. met 1x automaat 32A C 3p
 1x CEE-contactdoos 63A 5p 400V IP67 sch
 Alles beveiligd met de volgende aardlek's
 1x aardlek 63A 0.03A 4p



BALS FRONTBOX

NIEUW

- alle afgaande kabels aan één zijde
- recyclebare en loodvrije contactdozen
- ruimte voor 16 beveiligingseenheden
- ruimtebesparende vormgeving en stapelbaar
- robuuste behuizing van slagvast kunststof
- goed verplaatsbaar:
weegt slechts circa 6 kilo
- optioneel met statief
- testrapport online beschikbaar

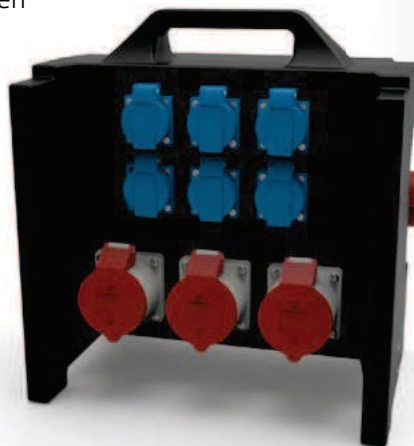

**Uitermate geschikt
voor werkplaatsen
in industrie en de bouw.**

Bestell-Nr. **K236984001**

Kunststof verdeler FRONTBOX
250x375x400 mm (LxBxH)
Ingang: CEE-toestelcontactdoos 32A 5p IP44
Doorlus: 1x CEE-contactdoos 32A 5p IP44
Uitgang:
6x Schuko IP54
 bev met 3x automaat 16A C 1p
2x CEE-contactdoos 32A 5p IP44
 bev met 1x automaat 25A C 3p
geheel bev. met 1x aardlek 40A 0,03A 4p



Bestell-Nr. **K236984002**

Kunststof verdeler FRONTBOX
250x375x400 mm (LxBxH)
Ingang: CEE-toestelcontactdoos 32A 5p IP44
Doorlus: 1x CEE-contactdoos 32A 5p IP44
Uitgang:
6x Schuko IP54
 bev met 3x automaat 16A C 1p
2x CEE-contactdoos 16A 5p IP44
 bev met 1x automaat 16A C 3p
geheel bev. met 1x aardlek 40A 0,03A 4p



Accessoires en onderdelen, klapvenster, aanrakingsveilig

- Zelfsluitend
- Met onderbak
- Optioneel met sluitgarnituur

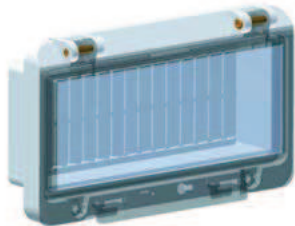

58009

Breedte	Hoogte	Diepte	Aantal modules	Bestell-Nr.
55	93.5	43	2	5881
91	93.5	43	4	5890
127	93.5	43	6	5899
162	93.5	43	8	58009
234	93.5	43	12	58018
257.50	93.5	43	13	58027
339	94.5	43	18	581640

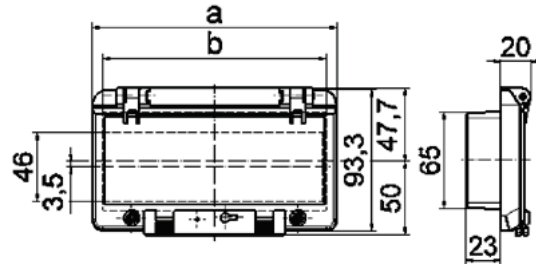

Accessoires en onderdelen, klapvenster, niet aanrakingsveilig

- Zelfsluitend
- Zonder onderbak
- Optioneel met sluitgarnituur



58010

Breedte	Hoogte	Diepte	Aantal modules	Bestell-Nr.
55	94.5	20	2	5882
91	94.5	20	4	5891
127	94.5	20	6	58001
162	94.5	20	8	58010
234	94.5	20	12	58019
257.50	94.5	20	13	58028
339	94.5	20	18	581644

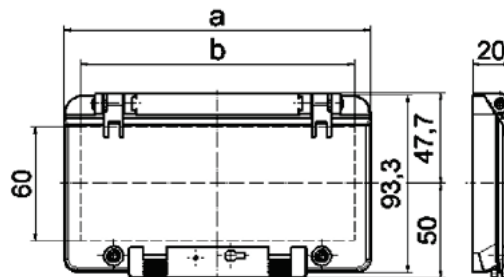

**Accessoires en onderdelen,
klapvenster, met montagerail**

- Zelfsluitend
- Met onderbak
- Optioneel met sluitgarnituur
- Met montagebeugels

Breedte	Hoogte	Diepte	Aantal modules	Bestell-Nr.
55	93.5	965	2	5885
91	93.5	965	4	5894
127	93.5	965	6	58004
162	93.5	965	8	58013
234	93.5	965	12	58022
257.50	93.5	965	13	58031

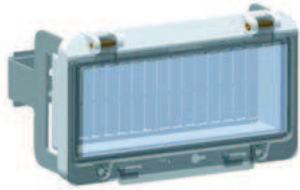

58013

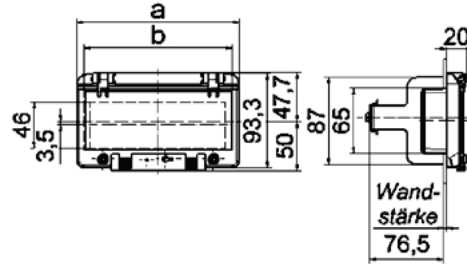

Slotgarnituur tbv klapvensters

Breedte	Hoogte	Diepte	Aantal modules Slot + 2 sleutels tbv klapvenster	Bestell-Nr.
				58037



58037

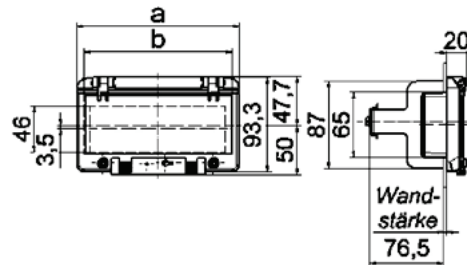

DIN-schroeven tbv klapvensters

Breedte

Hoogte

Diepte

Aantal modules

Bestell-Nr.

DIN Schuinroeven
zwart 15mm

58036

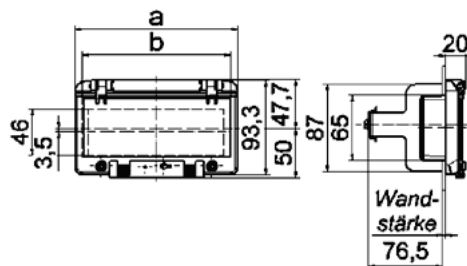

58036

Bestell-Nr. K12VB0631

- RVS regen- en/of bescherm dak
- Voor VARIABOX S en M
- RVS 304
- Voorzien de benodigde gaten voor gemakkelijke montage

**Bestell-Nr. K12VB0632**

- RVS regen- en/of bescherm dak
- Voor VARIABOX L en XL
- RVS 304
- Voorzien de benodigde gaten voor gemakkelijke montage



5 SPECIALE CONTACTMATERIALEN



7-polig CEE-contactmaterialen IP44



7-polig CEE-contactmaterialen IP67



Laagspanning contactmaterialen

CEE-wandcontactdoos, laagspanning



Pagina 136

CEE-inbouwcontactdoos, laagspanning



Pagina 136

CEE-inbouwcontactdoos, laagspanning



Pagina 136

CEE-inbouwcontactdoos, laagspanning



Pagina 137

CEE-inbouwcontactdoos, laagspanning



Pagina 137

CEE-wandtoestelcontactdoos, laagspanning



Pagina 137

CEE-steker, laagspanning



Pagina 138

CEE-koppeling, laagspanning



Pagina 138

CEE-stekers IP67 TN

CEE-wandcontactdoos



Pagina

CEE-steker



Pagina

CEE-koppeling



Pagina

CEE-steker TE, TN



Pagina 145

CEE-wandcontactdoos, 7-polig

- Schroefklemmen
- Hittebestendige contactdragers
- Kabelinvoer één keer boven (open), één keer achter (gesloten)
- Behuizingsbodem 180 gr draaibaar
- 4 bevestigingsgaten in behuizingsbodem
- Beschermingsklasse IP44

		110V 50-60 Hz	230V 50-60 Hz	400V 50-60 Hz	500V 50-60 Hz	>50V 301-500Hz	>50V 100-300Hz	kg
Ampere	Polen	3pol 4pol 5pol 4h 4h 4h	3pol 4pol 5pol 6h 9h 9h	3pol 4pol 5pol 9h 6h 6h	3pol 4pol 5pol 7h 7h 7h	3pol 4pol 5pol 2h 2h 2h	3pol 4pol 5pol 10h 10h 10h	Gewicht
16	7		11480	11481				0.373
32	7		11482	11483				0.454



11481

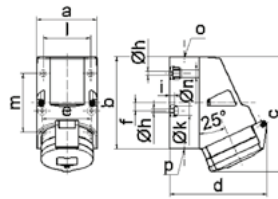

1 MB 2

Ampere Polzahl	16 4	16 5	32 3	32 4	32 5
a	83,0	83,0	83,0	83,0	83,0
b	126,0	126,0	126,0	126,0	126,0
c	153,0	155,0	155,0	155,0	155,0
d	127,0	130,0	130,0	130,0	136,0
e	68,0	68,0	68,0	68,0	68,0
f	11,0	11,0	11,0	11,0	11,0
h ø	5,5	5,5	5,5	5,5	5,5
l	6,5	6,5	6,5	6,5	6,5
k ø	12,0	12,0	12,0	12,0	12,0
m	65,0	65,0	65,0	65,0	65,0
n ø	80,0	80,0	80,0	80,0	80,0
o	10,0	10,0	10,0	10,0	10,0
p	M25	M25	M25	M25	M25
Leiter mm² min	2 x M25	2 x M25	2 x M25	2 x M25	2 x M25
Leiter mm² max	1,5	1,5	2,5	2,5	2,5
	4	4	10	10	10

CEE-wandcontactdoos, 7-polig

- Schroefklemmen
- Hittebestendige contactdragers
- Flens 75x75 mm
- Beschermingsklasse IP44

		110V 50-60 Hz	230V 50-60 Hz	400V 50-60 Hz	500V 50-60 Hz	>50V 301-500Hz	>50V 100-300Hz	kg
Ampere	Polen	3pol 4pol 5pol 4h 4h 4h	3pol 4pol 5pol 6h 9h 9h	3pol 4pol 5pol 9h 6h 6h	3pol 4pol 5pol 7h 7h 7h	3pol 4pol 5pol 2h 2h 2h	3pol 4pol 5pol 10h 10h 10h	Gewicht
16	7		13326	13327				0.191
32	7		13328	13329				0.270



13329

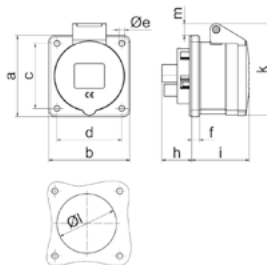

4 MB 389

Ampere Polzahl	16 7	32 7
a	75,0	75,0
b	75,0	75,0
c	60,0	60,0
d	60,0	60,0
e ø	5,5	5,5
f	7,0	8,0
h	28,0	38,0
i	53,0	62,0
k	85,0	98,0
l ø	60,0	60,0
m	11,0	17,0
Leiter mm² min	1,5	2,5
Leiter mm² max	4	10

CEE-wandcontactdoos, 7-polig

- Schroefklemmen
- Hittebestendige contactdragers
- Flens 100x92 mm
- Beschermingsklasse IP44

		110V 50-60 Hz	230V 50-60 Hz	400V 50-60 Hz	500V 50-60 Hz	>50V 301-500Hz	>50V 100-300Hz	kg
Ampere	Polen	3pol 4pol 5pol 4h 4h 4h	3pol 4pol 5pol 6h 9h 9h	3pol 4pol 5pol 9h 6h 6h	3pol 4pol 5pol 7h 7h 7h	3pol 4pol 5pol 2h 2h 2h	3pol 4pol 5pol 10h 10h 10h	Gewicht
16	7		12390	12391				0.213
32	7		12392	12393				0.315



12393

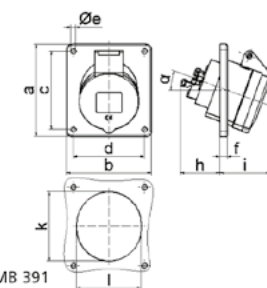

4 MB 391

Ampere Polzahl	16 7	32 7
a	100,0	100,0
b	92,0	92,0
c	85,0	85,0
d	77,0	77,0
e ø	5,5	5,5
f	8,0	8,0
h	46,0	61,0
i	55,0	60,0
k	70,0	78,0
l	70,0	78,0
α	20°	20°
Leiter mm² min	1,5	2,5
Leiter mm² max	4	10

CEE-steker TE, 7-polig

- Schroefklemmen
- Hittebestendige contactdragers
- Speciale trekontlasting
- Beschermingsklasse IP44



		110V 50-60 Hz	230V 50-60 Hz	400V 50-60 Hz	500V 50-60 Hz	>50V 301-500Hz	>50V 100-300Hz	kg
		3pol 4pol 5pol 4h 4h 4h	3pol 4pol 5pol 6h 9h 9h	3pol 4pol 5pol 9h 6h 6h	3pol 4pol 5pol 7h 7h 7h	3pol 4pol 5pol 2h 2h 2h	3pol 4pol 5pol 10h 10h 10h	Gewicht
16	7	210550		21557				0.219
32	7			210067				0.345



210067

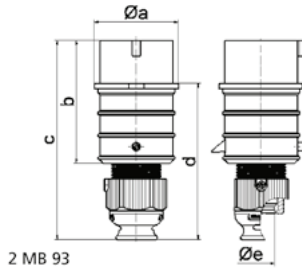

2 MB 93

Ampere	16	16	16	32	32	32
Polzahl	3	4	5	3	4	5
a ø	51,0	57,5	65,0	66,0	66,0	72,0
b	95,0	95,0	97,0	118,0	118,0	117,0
c	145,0	145,0	152,0	178,0	178,0	181,0
d	109,0	109,0	116,0	133,0	133,0	135,5
e ø	18,0	18,0	21,0	23,0	23,0	27,0
Leiter mm² min	1	1	1	2,5	2,5	2,5
Leiter mm² max	2,5	2,5	2,5	6	6	6

CEE-toestelcontactdoos TE, 7-polig, opbouw

- Schroefklemmen
- Hittebestendige contactdragers
- Vernikkelde contacten
- Beschermingsklasse IP44

24196



		110V 50-60 Hz	230V 50-60 Hz	400V 50-60 Hz	500V 50-60 Hz	>50V 301-500Hz	>50V 100-300Hz	kg
		3pol 4pol 5pol 4h 4h 4h	3pol 4pol 5pol 6h 9h 9h	3pol 4pol 5pol 9h 6h 6h	3pol 4pol 5pol 7h 7h 7h	3pol 4pol 5pol 2h 2h 2h	3pol 4pol 5pol 10h 10h 10h	Gewicht
16	7	24193		24194				0.340
32	7	24195		24196				0.416

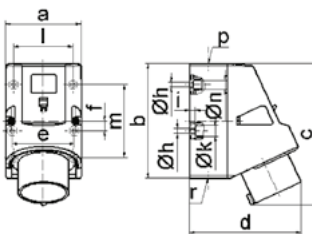

5 MB 45

Ampere	16	32	32	32
Polzahl	5	3	4	5
a	83,0	83,0	83,0	83,0
b	126,0	126,0	126,0	126,0
c	155,5	165,0	165,0	165,0
d	122,0	128,0	128,0	130,0
e	68,0	68,0	68,0	68,0
f	11,0	11,0	11,0	11,0
h ø	5,5	5,5	5,5	5,5
i	6,5	6,5	6,5	6,5
k ø	12,0	12,0	12,0	12,0
l	65,0	65,0	65,0	65,0
m	80,0	80,0	80,0	80,0
n ø	10	10,0	10,0	10,0
p	M25	M25	M25	M25
r	2xM25	2xM25	2xM25	2xM25
Leiter mm² min	1	2,5	2,5	2,5
Leiter mm² max	2,5	6	6	6

CEE- koppeling, 7-polig

- Schroefklemmen
- Hittebestendige contactdragers
- Beschermingsklasse IP44



		110V 50-60 Hz	230V 50-60 Hz	400V 50-60 Hz	500V 50-60 Hz	>50V 301-500Hz	>50V 100-300Hz	kg
		3pol 4pol 5pol 4h 4h 4h	3pol 4pol 5pol 6h 9h 9h	3pol 4pol 5pol 9h 6h 6h	3pol 4pol 5pol 7h 7h 7h	3pol 4pol 5pol 2h 2h 2h	3pol 4pol 5pol 10h 10h 10h	Gewicht
16	7	310311		31752				0.248
32	7			310123				0.391



310123

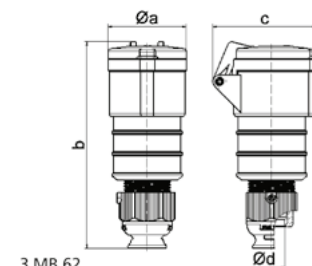

3 MB 62

Ampere	16	16	16	32	32	32
Polzahl	3	4	5	3	4	5
a ø	51,0	58,0	65,0	66,5	66,5	72,0
b	156,0	162,0	168,0	195,0	195,0	198,0
c	72,0	78,0	86,0	89,0	89,0	99,0
d ø	18,0	18,0	21,0	23,0	23,0	27,0
Leiter mm² min	1	1	1	2,5	2,5	2,5
Leiter mm² max	2,5	2,5	2,5	6	6	6

CEE-toestelcontactdoos TE, 7-polig, opbouw

- Schroefklemmen
- Hittebestendige contactdragers
- Vernikkelde contacten
- Beschermingsklasse IP44



110V
50-60 Hz

230V
50-60 Hz

400V
50-60 Hz

500V
50-60 Hz

>50V
301-500Hz

>50V
100-300Hz

kg
Gewicht

16	7	26012	26013	0.215
32	7	26002		0.298



26002

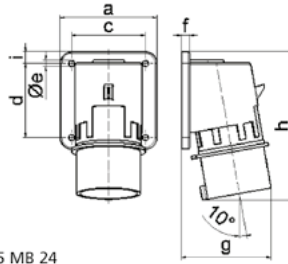

5 MB 24

Ampere	16	16	16	32	32	32
Polzahl	3	4	5	3	4	5
a	74,0	75,0	84,0	90,0	90,0	90,0
b	84,0	100,0	84,0	75,0	75,0	75,0
c	58,0	62,0	64,0	78,0	78,0	78,0
d	64,0	74,0	64,0	45,0	45,0	45,0
e ø	5,5	4,3	5,5	5,5	5,5	5,5
f	12,0	12,0	7,0	7,0	7,0	7,0
g	70,0	77,0	78,0	86,0	86,0	88,0
h	128,0	145,0	129,0	138,0	138,0	140,0
i	-	-	-	13,0	13,0	13,0
Leiter mm² min	1	1	1	2,5	2,5	2,5
Leiter mm² max	2,5	2,5	2,5	6	6	6

CEE-wandcontactdoos, 7-polig

- Schroefklemmen
- Hittebestendige contactdragers
- Beschermingsklasse IP67

		110V 50-60 Hz	230V 50-60 Hz	400V 50-60 Hz	500V 50-60 Hz	>50V 301-500Hz	>50V 100-300Hz	kg
		3pol 4pol 5pol 4h 4h 4h	3pol 4pol 5pol 6h 9h 9h	3pol 4pol 5pol 9h 6h 6h	3pol 4pol 5pol 7h 7h 7h	3pol 4pol 5pol 2h 2h 2h	3pol 4pol 5pol 10h 10h 10h	Gewicht
16	7	11634		11542				0.495



11542

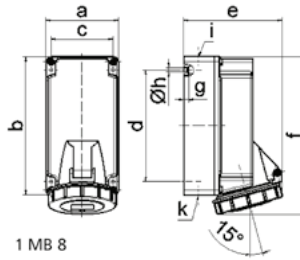

1 MB 8

Ampere Polzahl	16 3	16 4	16 5
a	90,0	90,0	90,0
b	170,0	170,0	170,0
c	77,0	77,0	77,0
d	137,5	137,5	137,5
e	108,0	115,0	122,0
f	191,5	191,5	195,0
g	6,5	6,5	6,5
h ø	5,5	5,5	5,5
i	M20	M20	M20
k	M20/25	M20/25	M20/25
Leiter mm² min	1,5	1,5	1,5
Leiter mm² max	4	4	4

CEE-wandcontactdoos TE, 7-polig

- Hittebestendige contactdragers
- Vernikkelde contacten
- Afschakelbaar
- Met mechanische dubbelvergrendeling
- In 0-stand vergrendelbaar
- Beschermingsklasse IP67

		110V 50-60 Hz	230V 50-60 Hz	400V 50-60 Hz	500V 50-60 Hz	>50V 301-500Hz	>50V 100-300Hz	kg
		3pol 4pol 5pol 4h 4h 4h	3pol 4pol 5pol 6h 9h 9h	3pol 4pol 5pol 9h 6h 6h	3pol 4pol 5pol 7h 7h 7h	3pol 4pol 5pol 2h 2h 2h	3pol 4pol 5pol 10h 10h 10h	Gewicht
32	7	160087					1.974	



16380

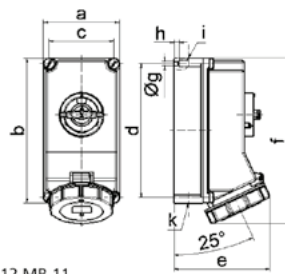

12 MB 11

Ampere Polzahl	16 4	16 5	32 3	32 4	32 5
a	118,0	118,0	118,0	118,0	118,0
b	225,0	225,0	225,0	225,0	225,0
c	101,0	101,0	101,0	101,0	101,0
d	208,0	208,0	208,0	208,0	208,0
e	127,0	134,0	143,0	143,0	149,0
f	245,0	245,0	255,0	255,0	255,0
g ø	6,5	6,5	6,5	6,5	6,5
h	8,0	8,0	8,0	8,0	8,0
i	2 x M25	2 x M25	2 x M25	2 x M25	2 x M25
k	2 x M25	2 x M25	2 x M25	2 x M25	2 x M25

CEE-toestelcontactdoos TE, opbouw, 7-polig

- Schroefklemmen
- Hittebestendige contactdragers
- Vernikkelde contacten
- Beschermingsklasse IP67

		110V 50-60 Hz	230V 50-60 Hz	400V 50-60 Hz	500V 50-60 Hz	>50V 301-500Hz	>50V 100-300Hz	kg
		3pol 4pol 5pol 4h 4h 4h	3pol 4pol 5pol 6h 9h 9h	3pol 4pol 5pol 9h 6h 6h	3pol 4pol 5pol 7h 7h 7h	3pol 4pol 5pol 2h 2h 2h	3pol 4pol 5pol 10h 10h 10h	Gewicht
16	7	26003		26004				0.246
32	7	26005		26006				0.333



26006

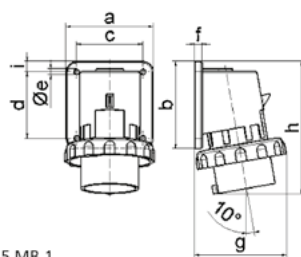

5 MB 1

Ampere Polzahl	16 3	16 4	16 5	32 3	32 4	32 5
a	74,0	75,0	84,0	90,0	90,0	90,0
b	84,0	100,0	84,0	75,0	75,0	75,0
c	58,0	62,0	64,0	78,0	78,0	78,0
d	64,0	74,0	64,0	45,0	45,0	45,0
e ø	5,5	4,3	5,5	5,5	5,5	5,5
f	12,0	12,0	7,0	7,0	7,0	7,0
g	80,0	88,0	90,0	100,0	100,0	101,0
h	128,0	145,0	129,0	138,0	138,0	139,0
i	-	-	10,0	13,0	13,0	13,0
Leiter mm² min	1	1	1	2,5	2,5	2,5
Leiter mm² max	2,5	2,5	2,5	6	6	6

CEE-toestelcontactdoos TE, inbouw, 7-polig

- Schroefklemmen
- Vernikkelde contacten
- Aan de achterkant geopend
- Flens 85x85
- Beschermingsklasse IP67

		110V 50-60 Hz	230V 50-60 Hz	400V 50-60 Hz	500V 50-60 Hz	>50V 301-500Hz	>50V 100-300Hz	kg
		3pol 4pol 5pol 4h 4h 4h	3pol 4pol 5pol 6h 9h 9h	3pol 4pol 5pol 9h 6h 6h	3pol 4pol 5pol 7h 7h 7h	3pol 4pol 5pol 2h 2h 2h	3pol 4pol 5pol 10h 10h 10h	Gewicht
16	7	27118						0.250
32	7	27120						0.372

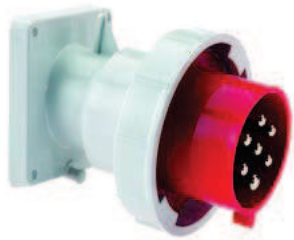

27120

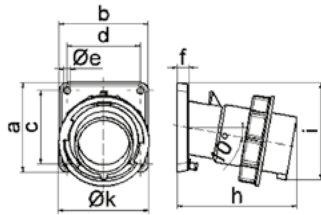

5 MB 22

Ampere	16	16	16	32	32	32
Polzahl	3	4	5	3	4	5
a	85,0	85,0	85,0	85,0	85,0	85,0
b	85,0	85,0	85,0	85,0	85,0	85,0
c	70,0	70,0	70,0	70,0	70,0	70,0
d	70,0	70,0	70,0	70,0	70,0	70,0
e ø	6,3	6,3	6,3	6,3	6,3	6,3
f	11,0	11,0	11,0	11,0	11,0	11,0
h	104,0	110,0	116,0	121,0	121,0	127,0
i	83,0	90,0	92,0	96,0	96,0	100,0
k	70,5	79,5	86,5	95,0	95,0	101,5
Leiter mm² min	1	1	1	2,5	2,5	2,5
Leiter mm² max	2,5	2,5	2,5	6	6	6

CEE-wandcontactdoos, 7-polig

- Schroefklemmen
- Hittebestendige contactdragers
- Beschermingsklasse IP67

		110V 50-60 Hz	230V 50-60 Hz	400V 50-60 Hz	500V 50-60 Hz	>50V 301-500Hz	>50V 100-300Hz	kg
		3pol 4pol 5pol 4h 4h 4h	3pol 4pol 5pol 6h 9h 9h	3pol 4pol 5pol 9h 6h 6h	3pol 4pol 5pol 7h 7h 7h	3pol 4pol 5pol 2h 2h 2h	3pol 4pol 5pol 10h 10h 10h	Gewicht
32	7	11714						0.875



11714

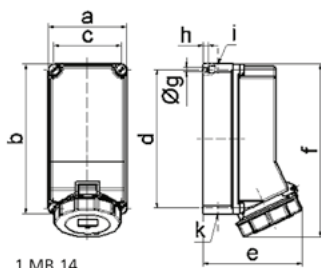

1 MB 14

Ampere	32	32	32
Polzahl	3	4	5
a	118,0	118,0	118,0
b	225,0	225,0	225,0
c	101,0	101,0	101,0
d	208,0	208,0	208,0
e	143,0	143,0	149,0
f	255,0	255,0	255,0
g ø	6,5	6,5	6,5
h	8,0	8,0	8,0
i	2xM25	2xM25	2xM25
k	2xM25	2xM25	2xM25
Leiter mm² min	2,5	2,5	2,5
Leiter mm² max	10	10	10

CEE-inbouwcontactdoos, 7-polig

- Schroefklemmen
- Hittebestendige contactdragers
- Flens 75x75 mm
- Beschermingsklasse IP67

		110V 50-60 Hz	230V 50-60 Hz	400V 50-60 Hz	500V 50-60 Hz	>50V 301-500Hz	>50V 100-300Hz	kg
		3pol 4pol 5pol 4h 4h 4h	3pol 4pol 5pol 6h 9h 9h	3pol 4pol 5pol 9h 6h 6h	3pol 4pol 5pol 7h 7h 7h	3pol 4pol 5pol 2h 2h 2h	3pol 4pol 5pol 10h 10h 10h	Gewicht
16	7	13330		13331			0.227	
32	7	13332		13333			0.316	



13333

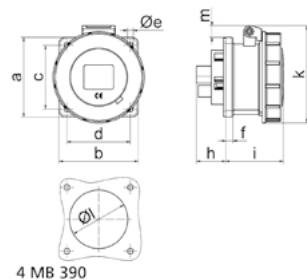

4 MB 390

Ampere	16	32
Polzahl	7	7
a	75,0	75,0
b	75,0	75,0
c	60,0	60,0
d	60,0	60,0
e ø	5,5	5,5
f	7,0	8,0
h	17,0	19,0
i	57,0	65,0
k	93,0	106,0
l ø	55,0	60,0
m	11,5	17,0
Leiter mm² min	1,5	2,5
Leiter mm² max	4	10

CEE-inbouwcontactdoos, 7-polig

- Schroefklemmen
- Hoek 20°
- Hittebestendige contactdragers
- Flens 100x92 mm
- Beschermingsklasse IP67



12397

		110V 50-60 Hz	230V 50-60 Hz	400V 50-60 Hz	500V 50-60 Hz	>50V 301-500Hz	>50V 100-300Hz	kg
		3pol 4pol 5pol 4h 4h 4h	3pol 4pol 5pol 6h 9h 9h	3pol 4pol 5pol 9h 6h 6h	3pol 4pol 5pol 7h 7h 7h	3pol 4pol 5pol 2h 2h 2h	3pol 4pol 5pol 10h 10h 10h	Gewicht
16	7		12394	12395				0.280
32	7		12396	12397				0.331

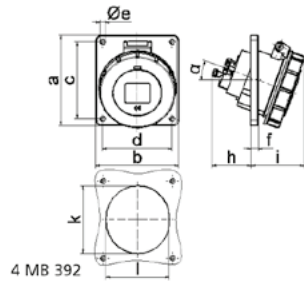

Ampere	16	32						
Polzahl	7	7						
a	100,0	100,0						
b	92,0	92,0						
c	85,0	85,0						
d	77,0	77,0						
e ø	5,5	5,5						
f	8,0	8,0						
h	46,0	61,0						
i	60,0	69,0						
k	70,0	78,0						
l	70,0	78,0						
α	20°	20°						
Leiter mm² min	1,5	2,5						
Leiter mm² max	4	10						

CEE-steker TE, 7-polig

- Schroefklemmen
- Hittebestendige contactdragers
- Vernikkelde contacten
- Speciale trekontlasting
- Beschermingsklasse IP67



21669

		110V 50-60 Hz	230V 50-60 Hz	400V 50-60 Hz	500V 50-60 Hz	>50V 301-500Hz	>50V 100-300Hz	kg
		3pol 4pol 5pol 4h 4h 4h	3pol 4pol 5pol 6h 9h 9h	3pol 4pol 5pol 9h 6h 6h	3pol 4pol 5pol 7h 7h 7h	3pol 4pol 5pol 2h 2h 2h	3pol 4pol 5pol 10h 10h 10h	Gewicht
16	7		21711	21667				0.253
32	7		21712	21669				0.405

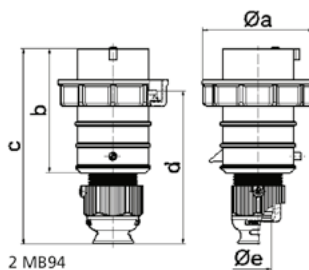

Ampere	16	16	16	32	32	32
Polzahl	3	4	5	3	4	5
a ø	70,0	78,0	86,0	94,0	94,0	101,0
b	95,0	95,0	97,0	118,0	118,0	117,0
c	145,0	145,0	152,0	178,0	178,0	181,0
d	111,0	111,0	119,0	136,0	136,0	138,5
e ø	18,0	18,0	21,0	23,0	23,0	27,0
Leiter mm² min	1	1	1	2,5	2,5	2,5
Leiter mm² max	2,5	2,5	2,5	6	6	6

CEE- koppeling, 7-polig

- Schroefklemmen
- Hittebestendige contactdragers
- Speciale trekontlasting
- Beschermingsklasse IP67



31515

		110V 50-60 Hz	230V 50-60 Hz	400V 50-60 Hz	500V 50-60 Hz	>50V 301-500Hz	>50V 100-300Hz	kg
		3pol 4pol 5pol 4h 4h 4h	3pol 4pol 5pol 6h 9h 9h	3pol 4pol 5pol 9h 6h 6h	3pol 4pol 5pol 7h 7h 7h	3pol 4pol 5pol 2h 2h 2h	3pol 4pol 5pol 10h 10h 10h	Gewicht
16	7		31512	31513				0.295
32	7		31514	31515				0.461

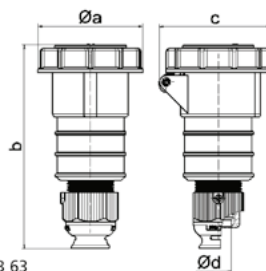

Ampere	16	16	16	32	32	32
Polzahl	3	4	5	3	4	5
a ø	70,5	78,0	86,5	94,0	94,0	101,5
b	161,0	161,0	168,0	196,0	196,0	200,0
c	77,0	83,0	93,0	99,0	99,0	107,0
d ø	18,0	18,0	21,0	23,0	23,0	27,0
Leiter mm² min	1	1	1	2,5	2,5	2,5
Leiter mm² max	2,5	2,5	2,5	6	6	6

CEE-wandcontactdoos TE, 7-polig

- Hittebestendige contactdragers
- Vernikkelde contacten
- Afschakelbaar
- Met mechanische dubbelvergrendeling
- In 0-stand vergrendelbaar
- Beschermingsklasse IP67



110V
50-60 Hz

230V
50-60 Hz

400V
50-60 Hz

500V
50-60 Hz

>50V
301-500Hz

>50V
100-300Hz

kg
Gewicht

16 7

16380

1.225



16380

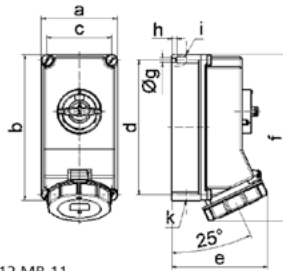

12 MB 11

Ampere	16	16	32	32	32
Polzahl	4	5	3	4	5
a	118,0	118,0	118,0	118,0	118,0
b	225,0	225,0	225,0	225,0	225,0
c	101,0	101,0	101,0	101,0	101,0
d	208,0	208,0	208,0	208,0	208,0
e	127,0	134,0	143,0	143,0	149,0
f	245,0	245,0	255,0	255,0	255,0
g	6,5	6,5	6,5	6,5	6,5
h	8,0	8,0	8,0	8,0	8,0
i	2 x M25	2 x M25	2 x M25	2 x M25	2 x M25
k	2 x M25	2 x M25	2 x M25	2 x M25	2 x M25

CEE-wandcontactdoos, laagspanning

- Schroefklemmen
- Kabelinvoer één maal boven (open)
- Beschermingsklasse IP44

Ampere	Polen	24V 50-60 Hz	42V 50-60 Hz	100-200Hz bis 50V	300Hz bis 50V	400Hz bis 50V	bis 50V	kg Gewicht
		12h	4h	2h	3h	10h		
16	2	410	411	412	413	414	415	0.177
16	3	416	417	418	419	4110	4107	0.194
32	2	4111	4112	4113	4114	4115	4116	0.176
32	3	4117	4118	4119	4120		4157	0.200



410

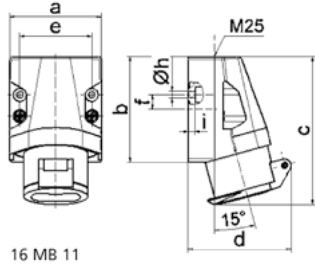

16 MB 11

Ampere	16	16	32	32		
Polzahl	2	3	2	3		
a	70,0	70,0	70,0	70,0		
b	80,0	80,0	80,0	80,0		
c	113,0	113,0	113,0	113,0		
d	80,0	80,0	80,0	80,0		
e	55,0	55,0	55,0	55,0		
f	11,0	11,0	11,0	11,0		
h o	5,2	5,2	5,2	5,2		
i	5,0	5,0	5,0	5,0		
Leiter mm² min	4	4	4	4		
Leiter mm² max	10	10	10	10		

CEE-inbouwcontactdoos, laagspanning

- Schroefklemmen
- Rechthoekig
- Flens 55x55 mm
- Beschermingsklasse IP44

Ampere	Polen	24V 50-60 Hz	42V 50-60 Hz	100-200Hz bis 50V	300Hz bis 50V	400Hz bis 50V	bis 50V	kg Gewicht
		12h	4h	2h	3h	10h		
16	2	430	431	432	433	434	435	0.107
16	3	436	437	438	439	4310	4390	0.126
32	2	4311	4312	4313	4314	4315	4316	0.110
32	3	4317	4318	4319	4320			0.126



430

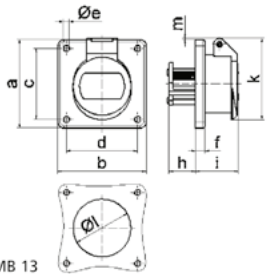

16 MB 13

Ampere	16	16	32	32		
Polzahl	2	3	2	3		
a	55,0	55,0	55,0	55,0		
b	55,0	55,0	55,0	55,0		
c	45,0	45,0	45,0	45,0		
d	45,0	45,0	45,0	45,0		
e o	5,2	5,2	5,2	5,2		
f	6,0	6,0	6,0	6,0		
h	22,0	22,0	22,0	22,0		
i	37,0	37,0	37,0	37,0		
k	67,0	67,0	67,0	67,0		
l o	49,0	49,0	49,0	49,0		
m	12,0	12,0	12,0	12,0		
Leiter mm² min	4	4	4	4		
Leiter mm² max	10	10	10	10		

CEE-inbouwcontactdoos, laagspanning

- Schroefklemmen
- Rechthoekig
- Flens 75x75 mm
- Beschermingsklasse IP44

Ampere	Polen	24V 50-60 Hz	42V 50-60 Hz	100-200Hz bis 50V	300Hz bis 50V	400Hz bis 50V	bis 50V	kg Gewicht
		12h	4h	2h	3h	10h		
16	2	4354	4355	4356	4357	4358	4359	0.120
16	3	4360	4361	4362	4363	4364		0.170
32	2	4365	4366	4367	4368	4369	4370	0.120
32	3	4371	4372	4373	4374			0.170



4354

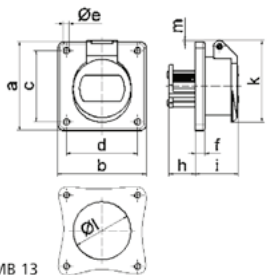

16 MB 13

Ampere	16	16	32	32		
Polzahl	2	3	2	3		
a	55,0	55,0	55,0	55,0		
b	55,0	55,0	55,0	55,0		
c	45,0	45,0	45,0	45,0		
d	45,0	45,0	45,0	45,0		
e o	5,2	5,2	5,2	5,2		
f	6,0	6,0	6,0	6,0		
h	22,0	22,0	22,0	22,0		
i	37,0	37,0	37,0	37,0		
k	67,0	67,0	67,0	67,0		
l o	49,0	49,0	49,0	49,0		
m	12,0	12,0	12,0	12,0		
Leiter mm² min	4	4	4	4		
Leiter mm² max	10	10	10	10		

CEE-inbouwcontactdoos, laagspanning

- Schroefklemmen
- Hoek 20°
- Flens 68x62 mm
- Beschermingsklasse IP44



420

Ampere	Polen	24V 50-60 Hz	42V 50-60 Hz	100-200Hz bis 50V	300Hz bis 50V	400Hz bis 50V	bis 50V	kg Gewicht
		...	12h	4h	2h	3h	10h	
16	2	420	421	422	423	424	425	0.114
16	3	426	427	428	429	4210		0.132
32	2	4211	4212	4213	4214	4215	4216	0.120
32	3	4217	4218	4219	4220			0.135

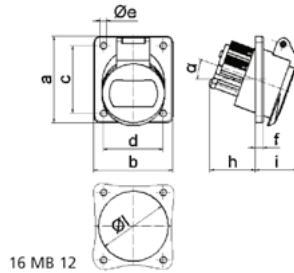

16 MB 12

Ampere	16	16	32	32		
Polzahl	2	3	2	3		
a	68,0	68,0	68,0	68,0		
b	62,0	62,0	62,0	62,0		
c	53,0	53,0	53,0	53,0		
d	47,0	47,0	47,0	47,0		
e Ø	5,2	5,2	5,2	5,2		
f	6,0	6,0	6,0	6,0		
h	36,0	36,0	36,0	36,0		
i	35,0	35,0	35,0	35,0		
α	20°	20°	20°	20°		
l Ø	55,0	55,0	55,0	55,0		
Leiter mm² min	4	4	4	4		
Leiter mm² max	10	10	10	10		

CEE-inbouwcontactdoos, laagspanning

- Schroefklemmen
- Hoek 20°
- Flens 100x92 mm
- Beschermingsklasse IP44



4222

Ampere	Polen	24V 50-60 Hz	42V 50-60 Hz	100-200Hz bis 50V	300Hz bis 50V	400Hz bis 50V	bis 50V	kg Gewicht
		...	12h	4h	2h	3h	10h	
16	2	4222	4223	4224	4225	4226	4227	0.146
16	3	4228	4229	4230	4231	4232		0.165
32	2	4233	4234	4235	4236	4237	4238	0.165
32	3	4239	4240	4241	4242			0.165

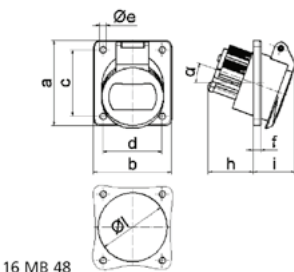

16 MB 48

Ampere	16	16	32	32		
Polzahl	2	3	2	3		
a	100,0	100,0	100,0	100,0		
b	92,0	92,0	92,0	92,0		
c	85,0	85,0	85,0	85,0		
d	77,0	77,0	77,0	77,0		
e Ø	5,2	5,2	5,2	5,2		
f	6,0	6,0	6,0	6,0		
h	36,0	36,0	36,0	36,0		
i	35,0	35,0	35,0	35,0		
α	20°	20°	20°	20°		
l Ø	55,0	55,0	55,0	55,0		
Leiter mm² min	4	4	4	4		
Leiter mm² max	10	10	10	10		

CEE-wandtoestelcontactdoos, laagspanning

- Schroefklemmen
- Beschermingsklasse IP44



460

Ampere	Polen	24V 50-60 Hz	42V 50-60 Hz	100-200Hz bis 50V	300Hz bis 50V	400Hz bis 50V	bis 50V	kg Gewicht
		...	12h	4h	2h	3h	10h	
16	2	460	461	462	463	464	465	0.140
16	3	466	467	468	469	4610		0.155
32	2	4611	4612				4616	0.135
32	3	4617	4618	4619				0.151

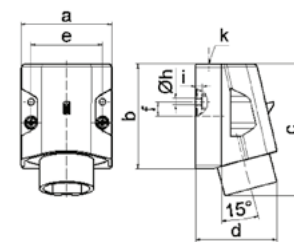

16 MB 15

Ampere	16	16	32	32		
Polzahl	2	3	2	3		
a	70,0	70,0	70,0	70,0		
b	80,0	80,0	80,0	80,0		
c	100,0	100,0	100,0	100,0		
d	82,0	82,0	82,0	82,0		
e	55,0	55,0	55,0	55,0		
f	11,0	11,0	11,0	11,0		
h Ø	5,2	5,2	5,2	5,2		
i	5,0	5,0	5,0	5,0		
k	M25	M25	M25	M25		
Leiter mm² min	4	4	4	4		
Leiter mm² max	10	10	10	10		

CEE-steker, laagspanning

- Schroefklemmen
- Vernikkelde contacten
- Speciale trekontlasting
- Beschermingsklasse IP44



4422

Ampere	Polen	24V 50-60 Hz	42V 50-60 Hz	100-200Hz bis 50V	300Hz bis 50V	400Hz bis 50V	bis 50V	kg Gewicht
		12h	4h	2h	3h	10h		
16	2	4422	4423	4424	4425	4426	4427	0.125
16	3	4428	4429	4430	4431	4432	4481	0.157
32	2	4433	4434	4435		4437	4438	0.125
32	3	4439	4440	4441	4442			0.161

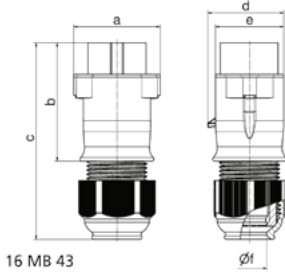

16 MB 43

Ampere	16	16	32	32		
Polzahl	2	3	2	3		
a	62,0	62,0	62,0	62,0		
b	85,0	85,0	85,0	85,0		
c	140,0	140,0	140,0	140,0		
d	55,0	55,0	55,0	55,0		
e	50,0	50,0	50,0	50,0		
f Ø	24,5	24,5	24,5	24,5		
Leiter mm² min	4	4	4	4		
Leiter mm² max	10	10	10	10		

CEE-koppeling, laagspanning

- Schroefklemmen
- Vernikkelde contacten
- Speciale trekontlasting
- Beschermingsklasse IP44



4522

Ampere	Polen	24V 50-60 Hz	42V 50-60 Hz	100-200Hz bis 50V	300Hz bis 50V	400Hz bis 50V	bis 50V	kg Gewicht
		12h	4h	2h	3h	10h		
16	2	4522	4523	4524	4525	4526	4527	0.185
16	3	4528	4529	4530	4531	4532		0.203
32	2	4533	4534	4535	4536	4537	4538	0.183
32	3	4539	4540	4541	4542			0.204

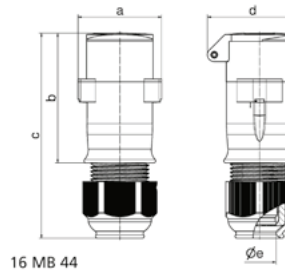

16 MB 44

Ampere	16	16	32	32		
Polzahl	2	3	2	3		
a	62,0	62,0	62,0	62,0		
b	96,0	96,0	96,0	96,0		
c	152,0	152,0	152,0	152,0		
d	67,0	67,0	67,0	67,0		
e Ø	24,5	24,5	24,5	24,5		
Leiter mm² min	4	4	4	4		
Leiter mm² max	10	10	10	10		

CEE-wandcontactdoos, gelijkstroom

- Schroefklemmen
- Beschermingsklasse IP44



11032

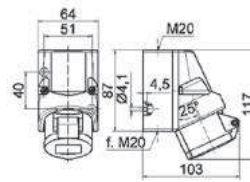

1 MB 35



2P+E 3P+E 3+N+E
Ampere Polen

>50 - 500V
3pol 4pol 5pol
1h 1h 1h

kg
Gewicht

16	3	11032	0.196

CEE-inbouwcontactdoos, gelijkstroom

- Schroefklemmen
- Rechthoekig
- Beschermingsklasse IP44



13070

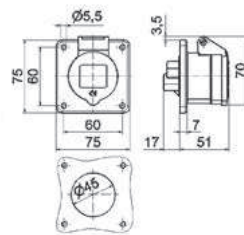

4 MB 74



2P+E 3P+E 3+N+E
Ampere Polen

>50 - 500V
3pol 4pol 5pol
1h 1h 1h

kg
Gewicht

16	3	13070	0.117

CEE-inbouwcontactdoos, gelijkstroom

- Schroefklemmen
- Hoekig
- Beschermingsklasse IP44



12144

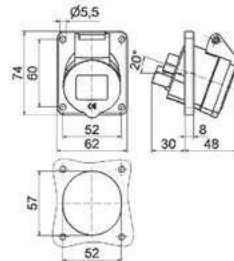

4 MB 73



2P+E 3P+E 3+N+E
Ampere Polen

>50 - 500V
3pol 4pol 5pol
1h 1h 1h

kg
Gewicht

16	3	12144	0.111

CEE-wandcontactdoos, gelijkstroom

- Schroefklemmen
- Vernikkelde contacten
- Afschakelbaar
- Met mechanische dubbelvergrendeling
- In 0-stand vergrendelbaar
- Beschermingsklasse IP44



16449

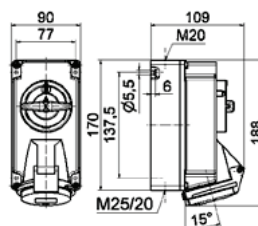

12 MB 28



2P+E 3P+E 3+N+E
Ampere Polen

>50 - 500V
3pol 4pol 5pol
1h 1h 1h

kg
Gewicht

16	3	16449	0.575

CEE-wandcontactdoos, gelijkstroom

- Schroefklemmen
- Vernikkelde contacten
- Afschakelbaar
- Met mechanische dubbelvergrendeling
- In 0-stand vergrendelbaar
- Beschermingsklasse IP44



16450

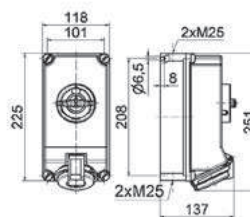

2P+E 3P+E 3+N+E
Ampere Polen

>50 - 500V
3pol 4pol 5pol
1h 1h 1h

kg
Gewicht

32	3	16450	1.180

6 CONTACTMATERIALEN VOOR SPECIALE TOEPASSINGEN



CEE-contactmaterialen, Type NATO

CEE-stekers IP67 TN



Pagina 145

CEE-contactmaterialen, Type NATO

CEE-stekers IP67 TN



Pagina 145

CEE-koppeling IP67 TN



Pagina 146

CEE-
inbouwcontactdoos,
schuin, IP67, TN



Pagina 147

CEE-
inbouwcontactdoos,
recht, IP67, TN



Pagina 148

CEE-
toestelcontactdozen
inbouw IP67, TN



Pagina 149

Schuko inbouwcon-
tactdoos TN, IP 68



Pagina 151

Schuko toestelcon-
tactdoos inbouw TN,
IP 67



Pagina 152

Schuko koppeling
TN, IP 68



Pagina 153

TN Klapvensters



Pagina 154

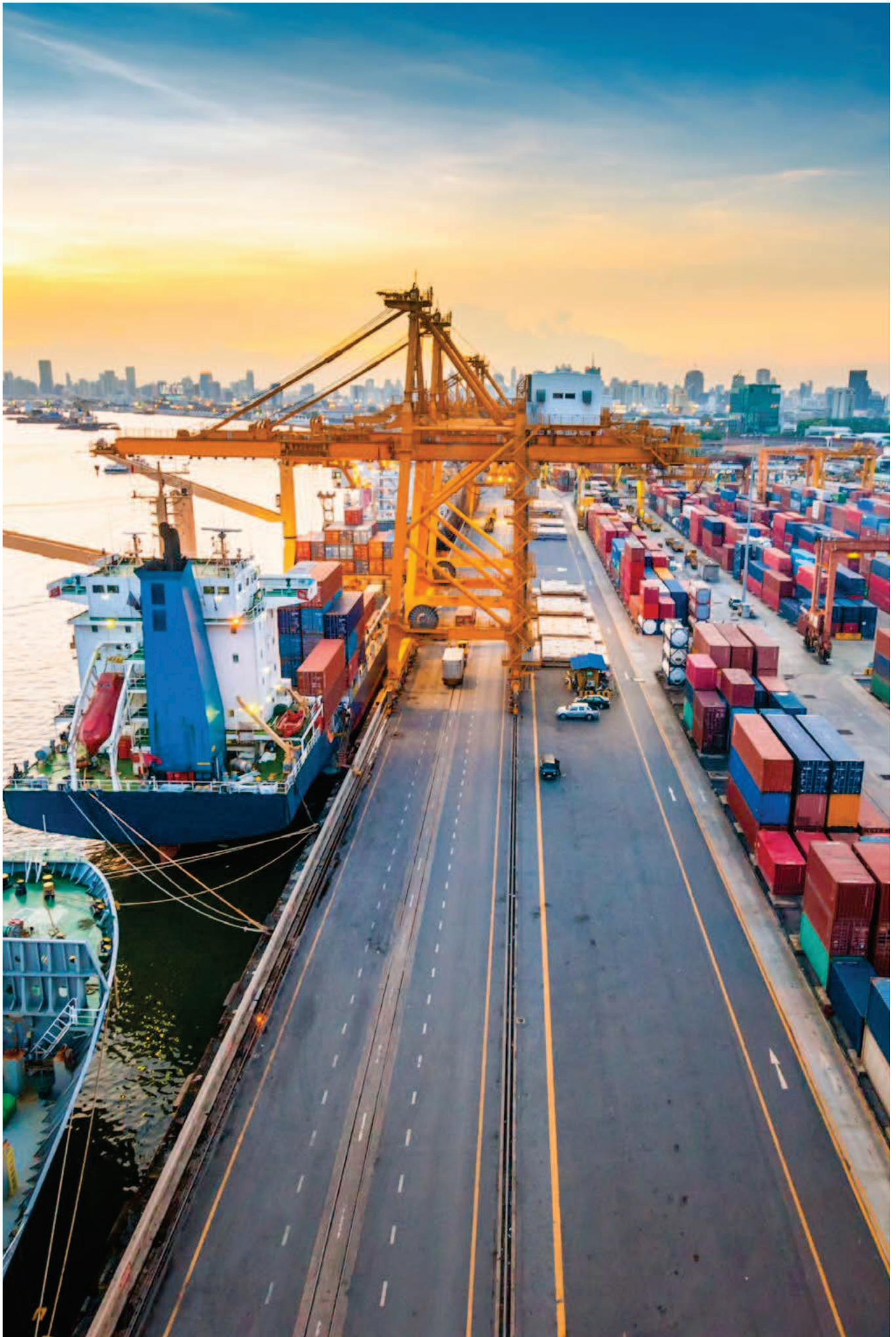

CEE-wandcontactdoos

- Schroefloze klemmen
- Hittebestendige contactdragers
- Vernikkelde contacten
- Beschermingsklasse IP67

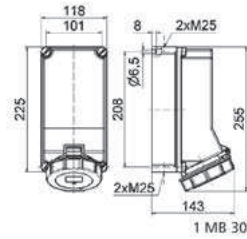

Amperes	3P+E Polen	380V(50Hz) en 440V(60Hz)	g
		3h	
32	4	11556	0.740

CEE-wandcontactdoos

- Schroefloze klemmen
- Mechanische dubbele vergrendeling
- In 0-stand hangslot vergrendeling mogelijk
- Hittebestendige contactdragers
- Vernikkelde contacten
- Beschermingsklasse IP67

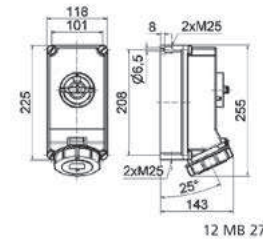

Amperes	3P+E Polen	380V(50Hz) en 440V(60Hz)	g
		3h	
32	4	16050	1.240

CEE-wandcontactdoos

- Schroefloze klemmen
- Mechanische dubbele vergrendeling
- Met monterail
- 6 module
- In 0-stand hangslot vergrendeling mogelijk
- Hittebestendige contactdragers
- Vernikkelde contacten
- Beschermingsklasse IP67

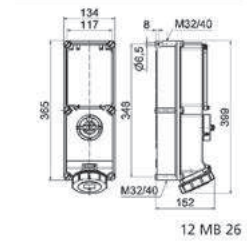

Amperes	3P+E Polen	380V(50Hz) en 440V(60Hz)	g
		3h	
32	4	17026	1.950

CEE-Inbouwcontactdoos

- Schroefklemmen
- Hittebestendige contactdragers
- Vernikkelde contacten
- Rechte uitvoering
- Beschermingsklasse IP67

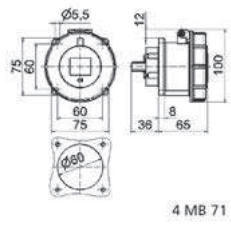

Amperes	3P+E Polen	380V(50Hz) en 440V(60Hz)	g
		3h	
32	4	13021	0.252

CEE-steker

- Schroefklemmen
- Eendelige behuizing
- Vernikkelde contacten
- Speciale trektoelasting
- Beschermingsklasse IP67

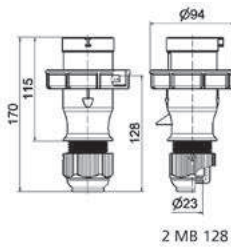

Amperes	3P+E Polen	380V(50Hz) en 440V(60Hz)	g
		3h	
32	4	210824	0.247

CEE-Inbouwtoestelcontactdoos

- Schroefklemmen
- Vernikkelde contacten
- Aan de achterkant geopend
- Flens 85x85
- Beschermingsklasse IP67



Amperes	3P+E Polen	380V(50Hz) en 440V(60Hz)	g
		3h	
32	4	27027	0.344

CEE-koppeling

- Schroefklemmen
- Eendelige behuizing
- Vernikkelde contacten
- Speciale trektoelasting
- Beschermingsklasse IP67

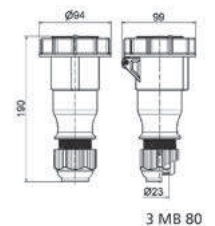

Amperes	3P+E Polen	380V(50Hz) en 440V(60Hz)	g
		3h	
32	4	310567	0.300



CEE-steker TE, TN

- Schroefklemmen
- Hittebestendige contactdragers
- Raamklemmen
- Vernikkelde contacten
- Speciale trekontlasting
- Met afdekdop
- Behuizingsaansluiting met schroefdraad en ratelsluiting
- Beschermingsklasse IP67



Ampere	Polen	230V 50-60 Hz			400V 50-60 Hz			400V 60 Hz			301-500Hz >50V			kg
		3pol 6h	4pol 9h	5pol 9h	3pol 9h	4pol 6h	5pol 6h	4pol 11h	5pol 11h	3pol 2h	4pol 2h	5pol 2h		
63	3	210256												0.695
63	4				210415									0.755
63	5				21210			21430						0.805
125	4				210265			210422						1.220
125	5				21033									1.330

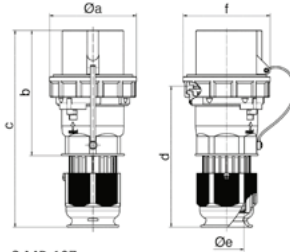

2 MB 107

Ampere	63	63	63	125	125	125
Polzahl	3	4	5	3	4	5
a ø	113,5	113,5	113,5	126,0	126,0	126,0
b	169,0	169,0	169,0	185,0	185,0	185,0
c	250,0	250,0	250,0	286,0	286,0	286,0
d	177,0	177,0	177,0	206,0	206,0	206,0
e ø	36,0	36,0	36,0	50,0	50,0	50,0
f	112,5	112,5	112,5	125,0	125,0	125,0
Leiter mm² min	6,0	6,0	6,0	16,0	16,0	16,0
Leiter mm² max	25,0	25,0	25,0	50,0	50,0	50,0

CEE-steker TE-Plus, TN

- Schroefloze klemmen
- Hittebestendige contactdragers
- Vernikkelde contacten
- Met afdekdop
- Speciale trekontlasting
- Beschermingsklasse IP67



Ampere	Polen	230V 50-60 Hz			400V 50-60 Hz			400V 60 Hz			301-500Hz >50V			kg
		3pol 6h	4pol 9h	5pol 9h	3pol 9h	4pol 6h	5pol 6h	4pol 11h	5pol 11h	3pol 2h	4pol 2h	5pol 2h		
16	3	21220									210403			0.180
16	4				210077			210405			210406			0.209
16	5				21423			21208			21424			0.265
32	3	21221									210408			0.329
32	4				210409			210078			210410			0.344
32	5				21209						21427			0.412

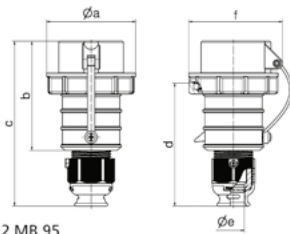

2 MB 95

Ampere	16	16	16	32	32	32
Polzahl	3	4	5	3	4	5
a ø	70,0	78,0	86,0	94,0	94,0	101,0
b	103,5	104,0	105,5	127,0	127,0	129,5
c	153,5	154,0	160,5	187,0	187,0	193,5
d	111,0	111,0	119,0	136,0	136,0	138,5
e ø	18,0	18,0	21,0	23,5	23,5	27,0
f	75,5	82,5	91,0	96,5	96,5	104,5
Leiter mm² min	1,0	1,0	1,0	2,5	2,5	2,5
Leiter mm² max	2,5	2,5	2,5	6,0	6,0	6,0

CEE-koppeling TE, TN

- Schroefklemmen
- Hittebestendige contactdragers
- Raamklemmen
- KONTEX contact
- Vernikkelde contacten
- Speciale trekonlasting
- Behuizingsaansluiting met schroefdraad en ratelsluiting
- Beschermingsklasse IP67



230V
50-60 Hz

400V
50-60 Hz

400V
60 Hz

301-500Hz
>50V

Ampere	Polen	230V 50-60 Hz	400V 50-60 Hz	400V 60 Hz	301-500Hz >50V	kg Gewicht
63	3	310058				0.760
63	4		31877	310175		0.855
63	5	31324	31152	31325	31326	0.785
125	3	310059				1.150
125	4		310060	310182		1.250
125	5		31027		31329	1.350

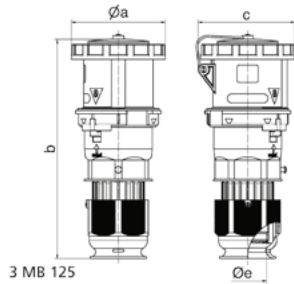

Ampere	Polzahl	63	63	63	125	125	125
a ø	3	110,0	110,0	110,0	125,0	125,0	125,0
b	4	263,0	263,0	263,0	300,0	300,0	300,0
c	5	113,0	113,0	113,0	128,0	128,0	128,0
d ø		36,0	36,0	36,0	50,0	50,0	50,0
Leiter mm² min		6,0	6,0	6,0	16,0	16,0	16,0
Leiter mm² max		16,0	16,0	16,0	50,0	50,0	50,0

CEE-koppeling TE-Plus, TN

- Schroefloze klemmen
- KONTEX contact
- Hittebestendige contactdragers
- Vernikkelde contacten
- Speciale trekonlasting
- Beschermingsklasse IP67



230V
50-60 Hz

400V
50-60 Hz

400V
60 Hz

301-500Hz
>50V

Ampere	Polen	230V 50-60 Hz	400V 50-60 Hz	400V 60 Hz	301-500Hz >50V	kg Gewicht
16	3	31162			310163	0.180
16	4		31865	310167	310168	0.206
16	5	31318	31150	31319	31320	0.255
32	3	31032			310194	0.360
32	4		31866	310171		0.341
32	5		31151	31322	31323	0.430

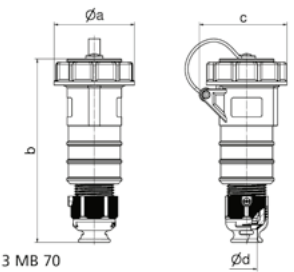

Ampere	Polzahl	16	16	16	32	32	32
a ø	3	70,5	78,0	86,5	94,0	94,0	101,5
b	4	161,0	161,0	168,0	196,0	196,0	200,0
c	5	77,0	83,0	93,0	99,0	99,0	107,0
d ø		18,0	18,0	21,0	23,0	23,0	27,0
Leiter mm² min		1,0	1,0	1,0	2,5	2,5	2,5
Leiter mm² max		2,5	2,5	2,5	6,0	6,0	6,0

CEE-inbouwcontactdoos, TN

- Schroefloze klemmen
- Recht
- KONTEX contact
- Hittebestendige contactdragers
- Vernikkelde contacten
- Beschermingsklasse IP67

QUICK CONNECT



		230V 50-60 Hz	400V 50-60 Hz	400V 60 Hz	301-500Hz >50V	kg
		3pol 4pol 5pol 6h 9h 9h	3pol 4pol 5pol 9h 6h 6h	4pol 5pol 11h 11h	3pol 4pol 5pol 2h 2h 2h	Gewicht
16	3	13064			13098	0.147
16	4		13633		13930	0.170
16	5	13189	13065	13182		0.195
32	3	13032				0.242
32	5		13066	13184	13175	0.298

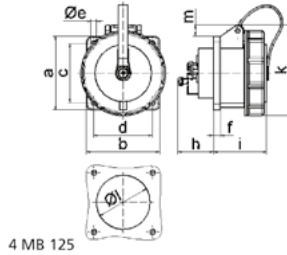

4 MB 125

Ampere	16	16	16	32	32	32
Polzahl	3	4	5	3	4	5
a	75,0	75,0	75,0	75,0	75,0	75,0
b	75,0	75,0	75,0	75,0	75,0	75,0
c	60,0	60,0	60,0	60,0	60,0	60,0
d	60,0	60,0	60,0	60,0	60,0	60,0
e ø	5,5	5,5	5,5	5,5	5,5	5,5
f	7,0	7,0	7,0	8,0	8,0	8,0
h	35,0	35,0	35,0	50,0	50,0	50,0
i	57,0	57,0	57,0	69,0	69,0	69,0
k	77,0	83,0	93,0	98,0	98,0	107,0
l ø	45,0	75,0	55,0	60,0	60,0	60,0
m	4,0	7,0	12,0	12,0	12,0	17,0
Leiter mm² min	1,5	1,5	1,5	2,5	2,5	2,5
Leiter mm² max	4,0	4,0	4,0	10,0	10,0	10,0

CEE-inbouwcontactdoos, TN

- Schroefklemmen
- Raamklemmen
- Hittebestendige contactdragers
- Raamklemmen
- KONTEX contact
- Vernikkelde contacten
- Beschermingsklasse IP67



		230V 50-60 Hz	400V 50-60 Hz	400V 60 Hz	301-500Hz >50V	kg
		3pol 4pol 5pol 6h 9h 9h	3pol 4pol 5pol 9h 6h 6h	4pol 5pol 11h 11h	3pol 4pol 5pol 2h 2h 2h	Gewicht
63	3	13186				0.500
63	4		13839	13925		0.550
63	5		13067	13187	13188	0.615
125	5		13647		13918	1.165

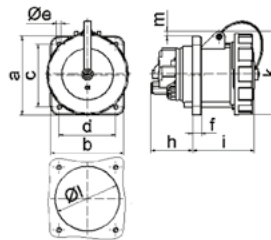

4 MB 134

Ampere	63	63	63	125	125	125
Polzahl	3	4	5	3	4	5
a	107,0	107,0	107,0	120,0	120,0	120,0
b	100,0	100,0	100,0	120,0	120,0	120,0
c	85,0	85,0	85,0	100,0	100,0	100,0
d	77,0	77,0	77,0	100,0	100,0	100,0
e ø	6,5	6,5	6,5	6,5	6,5	6,5
f	12,0	12,0	12,0	21,0	21,0	21,0
h	57,0	57,0	57,0	50,0	50,0	50,0
i	77,0	77,0	77,0	117,0	117,0	117,0
k	113,0	113,0	113,0	129,0	129,0	129,0
l ø	88,0	88,0	88,0	104,0	104,0	104,0
m	8,0	8,0	8,0	6,0	6,0	6,0
Leiter mm² min	6,0	6,0	6,0	25,0	25,0	25,0
Leiter mm² max	25,0	25,0	25,0	70,0	70,0	70,0

CEE-inbouwcontactdoos, TN

- Schroefloze klemmen
- Hoek 20°
- KONTEX contact
- Hittebestendige contactdragers
- Vernikkelde contacten
- Beschermingsklasse IP67

QUICK CONNECT



Ampere	Polen	230V 50-60 Hz	400V 50-60 Hz	400V 60 Hz	301-500Hz >50V	kg Gewicht
		3pol 4pol 5pol 6h 9h 9h	3pol 4pol 5pol 9h 6h 6h	4pol 5pol 11h 11h	3pol 4pol 5pol 2h 2h 2h	
16	3	12085			12280	0.153
16	4	120025	12699	120026	120027	0.179
16	5	12242	12086	12235	12236	0.200
32	3	12169			120029	0.250
32	4	120030	12700	120031	120032	0.280
32	5		12087	12237	12238	0.315

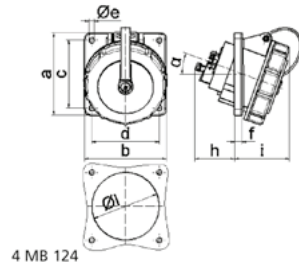

Ampere	16	16	16	32	32	32
Polzahl	3	4	5	3	4	5
a	85,0	85,0	85,0	85,0	85,0	85,0
b	85,0	85,0	85,0	85,0	85,0	85,0
c	70,0	70,0	70,0	70,0	70,0	70,0
d	70,0	70,0	70,0	70,0	70,0	70,0
e o	5,5	5,5	5,5	5,5	5,5	5,5
f	8,0	8,0	8,0	8,0	8,0	8,0
h	46,0	46,0	46,0	50,0	50,0	50,0
i	57,0	57,0	60,0	67,0	67,0	69,0
l o	57,0	65,0	70,0	78,0	78,0	78,0
α	20°	20°	20°	20°	20°	20°
Leiter mm² min	1,5	1,5	1,5	2,5	2,5	2,5
Leiter mm² max	4,0	4,0	4,0	10,0	10,0	10,0

4 MB 124

CEE-inbouwcontactdoos, TN

- Schroefklemmen
- Hoek
- Hittebestendige contactdragers
- Raamklemmen
- KONTEX contact
- Vernikkelde contacten
- Beschermingsklasse IP67



Ampere	Polen	230V 50-60 Hz	400V 50-60 Hz	400V 60 Hz	301-500Hz >50V	kg Gewicht
		3pol 4pol 5pol 6h 9h 9h	3pol 4pol 5pol 9h 6h 6h	4pol 5pol 11h 11h	3pol 4pol 5pol 2h 2h 2h	
63	3	12239			120034	
63	4	120035	12953	120036	120037	
63	5		12088		12241	0.630
125	3				120039	
125	4	120041		120042	120043	
125	5		12191		12264	1.045

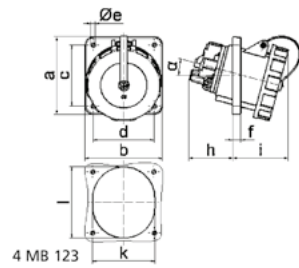

Ampere	63	63	63	125	125	125
Polzahl	3	4	5	3	4	5
a	114,0	114,0	114,0	114,0	114,0	114,0
b	114,0	114,0	114,0	114,0	114,0	114,0
c	90,0	90,0	90,0	90,0	90,0	90,0
d	90,0	90,0	90,0	90,0	90,0	90,0
e o	5,5	5,5	5,5	6,5	6,5	6,5
f	12,0	12,0	12,0	12,0	12,0	12,0
h	65,0	65,0	65,0	82,0	82,0	82,0
i	82,0	82,0	82,0	90,0	90,0	90,0
k	92,0	92,0	92,0	92,0	92,0	92,0
l	92,0	92,0	92,0	105,0	105,0	105,0
α	15°	15°	15°	15°	15°	15°
Leiter mm² min	6,0	6,0	6,0	25,0	25,0	25,0
Leiter mm² max	25,0	25,0	25,0	70,0	70,0	70,0

4 MB 123

CEE-toestelcontactdoos inbouw, TN

- Schroefklemmen
- Hoek 10°
- Raamklemmen
- Hittebestendige contactdragers
- Vernikkelde contacten
- Aan de achterkant geopend
- Beschermingsklasse IP67



Ampere	Polen	230V 50-60 Hz			400V 50-60 Hz			400V 60 Hz		301-500Hz >50V			kg Gewicht
		3pol 6h	4pol 9h	5pol 9h	3pol 9h	4pol 6h	5pol 6h	4pol 11h	5pol 11h	3pol 2h	4pol 2h	5pol 2h	
16	3	27046								27286			0.205
16	5	27104			2702			27105		27106			0.280
32	3	2745											0.304
32	4	27292			27201								0.330
32	5	27107			2703			27108		27043			0.365

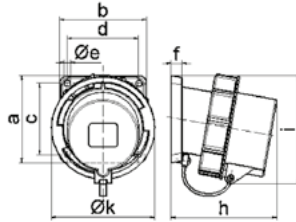

5 MB 31

Ampere	16	16	16	32	32	32
Polzahl	3	4	5	3	4	5
a	85,0	85,0	85,0	85,0	85,0	85,0
b	85,0	85,0	85,0	85,0	85,0	85,0
c	70,0	70,0	70,0	70,0	70,0	70,0
d	70,0	70,0	70,0	70,0	70,0	70,0
e ø	6,3	6,3	6,3	6,3	6,3	6,3
f	11,0	11,0	11,0	11,0	11,0	11,0
h	94,0	94,0	94,0	105,0	105,0	105,0
i	94,0	97,0	101,0	103,0	103,0	107,0
k	70,5	78,5	86,5	94,0	94,0	101,5
Leiter mm² min	1,0	1,0	1,0	2,5	2,5	2,5
Leiter mm² max	2,5	2,5	2,5	6,0	6,0	6,0

CEE-toestelcontactdoos inbouw, TN

- Schroefklemmen
- Hittebestendige contactdragers
- Raamklemmen
- Vernikkelde contacten
- Met afdekcap
- Beschermingsklasse IP67



Ampere	Polen	230V 50-60 Hz			400V 50-60 Hz			400V 60 Hz		301-500Hz >50V			kg Gewicht
		3pol 6h	4pol 9h	5pol 9h	3pol 9h	4pol 6h	5pol 6h	4pol 11h	5pol 11h	3pol 2h	4pol 2h	5pol 2h	
63	3	27267											0.665
63	4				27268			27297					0.730
63	5	27109			2704			27110		27045			0.775
125	3	27269											
125	4				27270								
125	5				27102								1.220

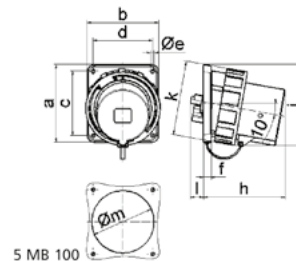

5 MB 100

Ampere	63	63	63	125	125	125
Polzahl	3	4	5	3	4	5
a	107,0	107,0	107,0	130,0	130,0	130,0
b	100,0	100,0	100,0	120,0	120,0	120,0
c	85,0	85,0	85,0	108,0	108,0	108,0
d	77,0	77,0	77,0	100,0	100,0	100,0
e ø	6,5	6,5	6,5	6,5	6,5	6,5
f	12,0	12,0	12,0	13,0	13,0	13,0
h	142,0	142,0	142,0	134,0	134,0	134,0
i	124,0	124,0	124,0	138,0	138,0	138,0
k	113,5	113,5	113,5	126,0	126,0	126,0
l	---	---	---	23,0	23,0	23,0
m ø	---	---	---	105,0	105,0	105,0
Leiter mm² min	6,0	6,0	6,0	16,0	16,0	16,0
Leiter mm² max	16,0	16,0	16,0	50,0	50,0	50,0

CEE-toestelcontactdoos inbouw, TN

- Schroefklemmen
- Hittebestendige contactdragers
- Vernikkelde contacten
- Met afdekcap
- Beschermingsklasse IP67



Ampere	Polen	230V 50-60 Hz			400V 50-60 Hz			400V 60 Hz		301-500Hz >50V			kg Gewicht
		3pol 6h	4pol 9h	5pol 9h	3pol 9h	4pol 6h	5pol 6h	4pol 11h	5pol 11h	3pol 2h	4pol 2h	5pol 2h	
16	3	2892											0.207
16	5				2894								0.259
32	3	2895											0.302
32	5				2897								0.358

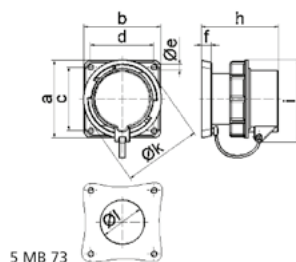

5 MB 73

Ampere	16	16	16	32	32	32
Polzahl	3	4	5	3	4	5
a	85,0	85,0	85,0	85,0	85,0	85,0
b	85,0	85,0	85,0	85,0	85,0	85,0
c	70,0	70,0	70,0	70,0	70,0	70,0
d	70,0	70,0	70,0	70,0	70,0	70,0
e ø	6,3	6,3	6,3	6,3	6,3	6,3
f	11,0	11,0	11,0	11,0	11,0	11,0
h	84,0	84,0	85,0	94,0	94,0	94,0
i	82,5	86,0	91,0	96,5	96,5	104,0
k ø	70,5	78,5	86,5	94,0	94,0	101,5
l ø	49,0	49,0	49,0	49,0	49,0	49,0
Leiter mm² min	1,0	1,0	1,0	2,5	2,5	2,5
Leiter mm² max	2,5	2,5	2,5	6,0	6,0	6,0

CEE-toestelcontactdoos inbouw, TN

- Schroefklemmen
- Hittebestendige contactdragers
- Raamklemmen
- Vernikkelde contacten
- Met afdekdop
- Beschermingsklasse IP67

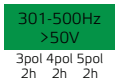

kg
Gewicht

63	3	28042			
63	4	28000			
63	5	2853			0.725
125	3	28043			
125	4	28044			
125	5	28045			

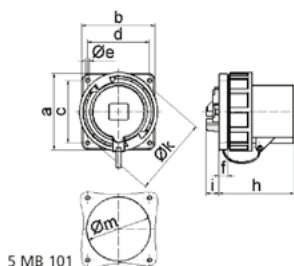

Ampere	63	63	63	125	125	125
Polzahl	3	4	5	3	4	5
a	110,0	110,0	110,0	120,0	120,0	120,0
b	106,0	106,0	106,0	120,0	120,0	120,0
c	90,0	90,0	90,0	100,0	100,0	100,0
d	90,0	90,0	90,0	100,0	100,0	100,0
e o	5,5	5,5	5,5	6,5	6,5	6,5
f	13,0	13,0	13,0	13,0	13,0	13,0
h	114,0	114,0	114,0	121,0	121,0	121,0
i	19,0	19,0	19,0	20,0	20,0	20,0
k o	113,5	113,5	113,5	126,0	126,0	126,0
m o	93,0	93,0	93,0	104,0	104,0	104,0
Leiter mm ² min	6,0	6,0	6,0	16,0	16,0	16,0
Leiter mm ² max	16,0	16,0	16,0	50,0	50,0	50,0

Schuko-inbouwcontactdoos TN

- Schroefklemmen
- Vernikkelde contacten
- 16A/230V~
- Beschermingsklasse IP68



7115

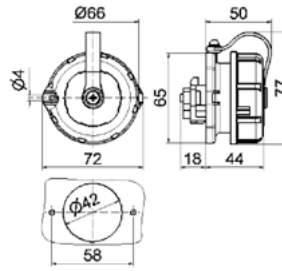

18 MB 21

Uitvoering	Kleur	Bestelnr
Randaarde	Groen	7115

Schuko-inbouwcontactdoos TN

- Schroefklemmen
- Vernikkelde contacten
- 16A/230V~
- Beschermingsklasse IP68



7108

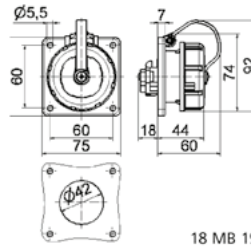

18 MB 19

Uitvoering	Kleur	Bestelnr
Randaarde	Groen	7108
Penaarde	Groen	7185

**Schuko-toestelcontactdoos
inbouw TN**

- Schroefklemmen
- Vernikkelde contacten
- 16A/230V~
- Met afdekdop
- Beschermingsklasse IP67



753

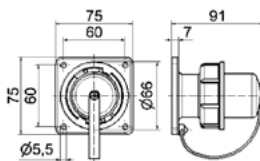

18 MB 16

Uitvoering	Kleur	Bestelnr
Randaarde	Groen	753

Schuko-koppeling TN

- Schroefklemmen
- Vernikkelde contacten
- 16A/230V~
- Beschermingsklasse IP68



745

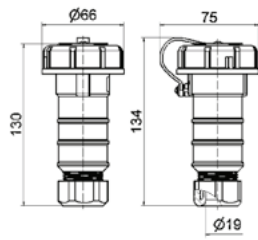

18 MB 26

Uitvoering	Kleur	Bestelnr
Randaarde	Groen	745

Schuko-driewegkoppeling TN

- Schroefklemmen
- Vernikkelde contacten
- 16A/230V~
- Met afdekdop, ophangbeugel en wartel
- Beschermingsklasse IP68



7400

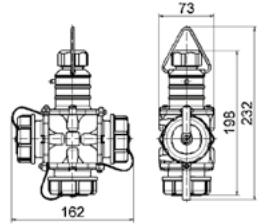

18 MB 27

Uitvoering	Kleur	Bestelnr
Randaarde	Groen	7400

TN klapvenster

- Zelfsluitend
- Met onderbak
- Optioneel met sluitgarnituur

Breedte	Hoogte	Diepte	Aantal modules	Bestell-Nr.
339	94.5	43	18	581642



58110

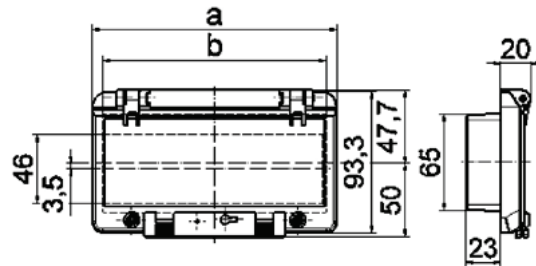

TN klapvenster

- Zelfsluitend
- Zonder onderbak
- Optioneel met sluitgarnituur

Breedte	Hoogte	Diepte	Aantal modules	Bestell-Nr.
55	94.5	20	2	58511
91	94.5	20	4	580020
127	94.5	20	6	58503
162	94.5	20	8	58502
234	94.5	20	12	58602
257.50	94.5	20	13	58607
339	94.5	20	18	581646



58502

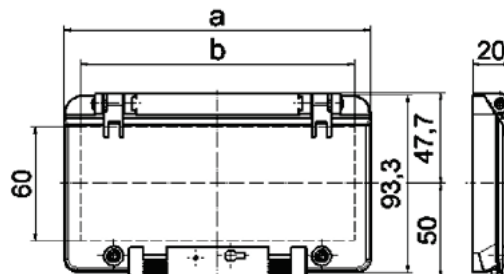

Art.Nr.	Pagina	Art.Nr.	Pagina	Art.Nr.	Pagina	Art.Nr.	Pagina
107	31	433	139	1146	28	2155	69
108	31	434	139	1147	28	2180	71
109	31	435	139	1148	28	2181	71
129	58	436	139	1149	28	2182	71
134	51	437	139	1150	28	2183	71
136	51	438	139	1151	28	2184	71
156	39	439	139	1152	28	2185	71
200	68	460	140	1153	28	2186	71
201	68	461	140	1154	28	2187	71
210	68	462	140	1155	28	2188	71
211	68	463	140	1156	29	2189	71
212	68	464	140	1157	29	2190	71
214	68	465	140	1158	29	2191	71
216	68	466	140	1159	29	2192	71
217	68	467	140	1160	29	2193	71
224	83	468	140	1161	29	2194	71
225	83	469	140	1162	29	2195	71
227	83	712	96	1163	29	2196	71
231	69	713	96	1164	29	2197	71
236	69	714	96	1200	58	2198	71
240	72	724	96	1201	54	2199	71
242	73	736	98	1202	54	2251	86
245	72	737	98	1203	58	2252	86
249	72	745	156	1204	54	2266	86
260	77	746	99	1205	58	2267	86
261	77	747	99	1206	58	2271	83
262	77	749	99	1207	54	2286	83
263	77	753	155	1208	54	2287	83
264	77	754	97	1299	59	2288	83
265	77	755	97	1301	51	2300	69
266	77	1010	31	1304	51	2400	74
267	77	1011	32	1305	51	2402	75
268	77	1012	31	1306	51	2415	72
300	87	1013	31	1307	51	2470	74
301	87	1015	32	1308	51	2471	74
310	87	1017	32	1395	55	2472	75
311	87	1018	32	1396	55	2473	75
312	87	1019	32	1397	55	2476	75
314	87	1020	32	1398	55	2477	75
315	87	1104	27	1399	55	2478	75
316	87	1106	27	1580	42	2483	75
317	87	1107	27	1582	39	2484	75
410	139	1108	27	1583	39	2485	75
411	139	1112	29	1584	39	2486	75
412	139	1124	27	1585	39	2487	75
413	139	1125	27	1610	43	2488	75
414	139	1126	27	1611	43	2489	75
415	139	1127	27	1616	43	2490	75
416	139	1128	27	1619	43	2491	75
417	139	1129	27	1641	43	2492	75
418	139	1130	27	1642	43	2493	75
419	139	1132	28	1674	38	2494	75
420	140	1133	28	1675	38	2495	75
421	140	1134	28	1676	38	2600	77
422	140	1135	28	2104	69	2602	84
423	140	1136	28	2114	68	2603	84
424	140	1137	28	2115	68	2604	79
425	140	1138	28	2120	68	2607	86
426	140	1139	28	2123	68	2608	86
427	140	1140	28	2149	69	2611	77
428	140	1141	28	2150	69	2612	77
429	140	1142	28	2151	69	2625	77
430	139	1143	28	2152	69	2626	77
431	139	1144	28	2153	69	2627	77
432	139	1145	28	2154	69	2628	77

Art.Nr.	Pagina	Art.Nr.	Pagina	Art.Nr.	Pagina	Art.Nr.	Pagina
2629	77	2897	152	4157	139	4390	139
2630	77	2898	81	4210	140	4422	141
2631	77	2899	82	4211	140	4423	141
2632	77	3104	88	4212	140	4424	141
2635	77	3108	88	4213	140	4425	141
2636	77	3109	88	4214	140	4426	141
2637	79	3110	87	4215	140	4427	141
2638	79	3111	87	4216	140	4428	141
2639	79	3112	88	4217	140	4429	141
2641	79	3114	87	4218	140	4430	141
2642	79	3115	87	4219	140	4431	141
2643	79	3117	87	4220	140	4432	141
2647	79	3118	87	4222	140	4433	141
2648	79	3119	87	4223	140	4434	141
2649	77	3124	90	4224	140	4435	141
2652	84	3125	87	4225	140	4437	141
2655	77	3126	87	4226	140	4438	141
2656	77	3129	87	4227	140	4439	141
2657	77	3130	87	4228	140	4440	141
2658	77	3135	87	4229	140	4441	141
2659	79	3136	87	4230	140	4442	141
2660	79	3137	87	4231	140	4481	141
2661	79	3138	87	4232	140	4522	141
2662	77	3141	87	4233	140	4523	141
2663	77	3142	87	4234	140	4524	141
2664	77	3147	87	4235	140	4525	141
2671	77	3148	87	4236	140	4526	141
2674	84	3149	88	4237	140	4527	141
2679	77	3150	88	4238	140	4528	141
2684	77	3151	88	4239	140	4529	141
2685	77	3152	88	4240	140	4530	141
2702	152	3153	88	4241	140	4531	141
2703	152	3154	88	4242	140	4532	141
2704	152	3180	90	4310	139	4533	141
2736	80	3181	90	4311	139	4534	141
2738	80	3182	90	4312	139	4535	141
2739	80	3183	90	4313	139	4536	141
2740	80	3184	90	4314	139	4537	141
2741	80	3185	90	4315	139	4538	141
2743	80	3186	90	4316	139	4539	141
2744	80	3187	90	4317	139	4540	141
2745	152	3188	90	4318	139	4541	141
2771	78	3190	90	4319	139	4542	141
2774	78	3191	90	4320	139	4610	140
2775	78	3192	90	4354	139	4611	140
2776	78	3193	90	4355	139	4612	140
2781	78	3194	90	4356	139	4616	140
2783	80	3195	90	4357	139	4617	140
2786	80	3196	90	4358	139	4618	140
2787	80	3197	90	4359	139	4619	140
2793	80	3198	90	4360	139	5881	124
2835	82	3199	90	4361	139	5882	124
2836	82	3214	88	4362	139	5885	125
2838	82	4107	139	4363	139	5890	124
2842	82	4110	139	4364	139	5891	124
2853	153	4111	139	4365	139	5894	125
2857	85	4112	139	4366	139	5899	124
2860	82	4113	139	4367	139	7108	154
2861	82	4114	139	4368	139	7112	96
2870	85	4115	139	4369	139	7115	154
2876	82	4116	139	4370	139	7153	96
2881	82	4117	139	4371	139	7185	154
2892	152	4118	139	4372	139	7370	98
2894	152	4119	139	4373	139	7400	156
2895	152	4120	139	4374	139	7416	99

Art.Nr.	Pagina	Art.Nr.	Pagina	Art.Nr.	Pagina	Art.Nr.	Pagina
7432	99	11797	33	12052	60	12570	58
7455	99	11798	33	12053	60	12571	58
7486	99	11799	33	12054	60	12572	58
7488	99	11800	34	12055	59	12573	58
11014	37	11801	34	12074	53	12574	58
11017	29	11802	34	12085	151	12596	60
11025	28	11803	34	12086	151	12646	60
11027	28	11812	36	12087	151	12648	60
11032	142	11813	36	12088	151	12649	60
11038	37	11814	36	12100	59	12650	60
11052	37	11815	36	12101	59	12651	60
11126	29	11822	35	12103	59	12652	60
11208	27	11823	35	12104	59	12653	60
11221	27	11824	35	12105	59	12699	151
11320	28	11825	35	12106	59	12700	151
11326	28	11826	36	12107	59	12730	53
11342	28	11827	36	12108	59	12731	52
11343	28	11828	36	12133	59	12732	52
11350	28	11829	36	12134	54	12733	52
11368	29	11906	26	12135	54	12734	52
11390	28	11907	26	12136	54	12735	52
11429	27	11909	26	12137	54	12736	52
11432	28	11928	26	12138	54	12739	52
11436	29	11930	26	12139	60	12740	52
11437	29	11931	26	12144	142	12741	52
11438	29	11932	26	12156	64	12742	52
11439	29	11933	26	12160	64	12743	52
11440	29	11934	26	12169	151	12744	52
11441	29	11936	26	12171	58	12745	52
11442	29	11944	26	12191	151	12746	52
11443	29	11945	26	12195	54	12747	52
11444	29	11947	26	12205	63	12748	52
11445	29	11949	26	12235	151	12749	52
11446	29	11955	26	12236	151	12750	52
11447	29	11956	26	12237	151	12751	52
11448	33	11957	26	12238	151	12752	52
11449	33	11960	26	12239	151	12753	52
11451	33	11962	26	12241	151	12754	52
11452	35	11963	26	12242	151	12755	52
11453	35	11968	33	12264	151	12756	52
11455	35	11972	33	12280	151	12757	52
11461	28	11973	33	12320	59	12758	52
11476	30	11977	33	12390	132	12759	52
11477	30	11978	33	12391	132	12760	52
11478	30	11979	33	12392	132	12761	52
11479	30	11983	33	12393	132	12762	52
11480	132	11984	26	12394	137	12763	52
11481	132	11984	33	12395	137	12764	52
11482	132	11985	33	12396	137	12765	52
11483	132	11989	33	12397	137	12766	52
11485	33	11990	33	12398	61	12767	52
11487	33	11991	33	12401	61	12768	52
11493	28	11995	33	12405	62	12769	52
11496	28	11997	34	12406	62	12770	52
11538	33	11998	34	12407	62	12771	53
11542	135	11999	34	12408	62	12772	53
11556	146	12000	58	12409	64	12773	53
11634	135	12001	58	12410	64	12774	53
11640	27	12002	58	12555	60	12775	53
11714	136	12004	58	12563	53	12776	53
11785	37	12020	60	12565	53	12777	53
11786	37	12025	60	12566	53	12778	53
11787	37	12032	58	12567	53	12779	53
11790	35	12035	58	12568	53	12780	53
11796	33	12039	58	12569	58	12781	53

Art.Nr.	Pagina	Art.Nr.	Pagina	Art.Nr.	Pagina	Art.Nr.	Pagina
12782	53	12855	57	13189	150	13686	50
12783	53	12856	57	13326	132	13687	50
12784	53	12857	57	13327	132	13688	50
12785	53	12861	52	13328	132	13689	50
12786	53	12862	52	13329	132	13690	50
12787	53	12863	52	13330	136	13691	50
12788	53	12864	52	13331	136	13692	50
12789	53	12865	52	13332	136	13693	50
12790	53	12866	52	13333	136	13694	50
12791	53	12867	52	13334	61	13695	50
12792	53	12868	52	13336	61	13696	50
12793	53	12869	52	13341	61	13697	50
12794	53	12870	52	13342	61	13698	50
12795	53	12871	52	13343	61	13699	50
12796	53	12872	52	13344	61	13700	50
12797	53	12873	52	13382	63	13701	50
12798	53	12874	53	13383	63	13702	50
12799	53	12876	61	13384	63	13703	50
12800	53	12877	61	13385	63	13704	50
12801	53	12878	61	13434	56	13705	50
12802	53	12880	61	13435	56	13706	50
12803	53	12882	61	13436	56	13707	50
12804	53	12883	61	13442	56	13708	50
12805	53	12884	61	13445	56	13709	50
12806	53	12917	57	13447	56	13710	50
12808	57	12919	63	13448	56	13711	50
12809	57	12920	63	13449	56	13712	50
12810	57	12921	63	13451	56	13713	50
12811	57	12922	63	13452	56	13714	50
12812	57	12924	63	13476	61	13715	50
12813	57	12925	63	13515	56	13716	50
12814	57	12926	63	13592	51	13717	50
12815	57	12927	63	13633	150	13718	50
12816	57	12928	63	13646	50	13719	55
12817	57	12929	57	13647	150	13720	55
12818	57	12930	57	13656	50	13721	55
12819	57	12931	57	13657	50	13724	55
12820	57	12953	151	13658	50	13725	55
12821	57	13021	146	13659	50	13726	55
12822	57	13032	150	13660	50	13727	55
12823	57	13051	51	13661	50	13730	55
12824	57	13064	150	13662	50	13731	55
12825	57	13065	150	13663	50	13732	55
12826	57	13066	150	13664	50	13733	55
12831	57	13067	150	13665	50	13734	55
12832	57	13070	142	13666	50	13735	55
12833	57	13083	63	13667	50	13737	55
12834	57	13098	150	13668	50	13738	55
12835	57	13100	55	13669	50	13739	55
12836	57	13101	55	13670	50	13740	55
12837	57	13102	55	13671	50	13741	55
12838	57	13103	55	13672	50	13742	55
12839	57	13104	55	13673	50	13743	55
12840	57	13140	51	13674	50	13744	55
12842	57	13144	61	13675	50	13745	55
12843	57	13156	63	13676	50	13746	55
12844	57	13157	63	13677	50	13748	55
12846	57	13159	63	13678	50	13749	55
12847	57	13168	51	13679	50	13750	55
12848	57	13175	150	13680	50	13751	55
12849	57	13182	150	13681	50	13754	55
12850	57	13184	150	13682	50	13755	55
12852	57	13186	150	13683	50	13756	55
12853	57	13187	150	13684	50	13757	55
12854	57	13188	150	13685	50	13758	55

Art.Nr.	Pagina	Art.Nr.	Pagina	Art.Nr.	Pagina	Art.Nr.	Pagina
13760	55	16138	44	21060	71	21669	137
13761	55	16380	138	21154	71	21686	68
13762	55	16449	142	21155	71	21687	68
13763	55	16450	142	21156	71	21688	68
13764	55	16602	44	21163	71	21689	68
13765	55	16603	43	21167	69	21690	68
13771	61	16604	44	21208	148	21691	68
13773	61	16605	43	21209	148	21692	68
13774	61	16606	44	21210	148	21693	68
13775	61	16620	45	21213	68	21711	137
13776	61	16621	45	21220	148	21712	137
13777	61	16622	45	21221	148	21754	70
13810	63	16827	43	21237	70	21837	68
13812	63	16828	44	21238	70	21838	68
13813	63	16831	45	21239	70	21839	68
13814	63	16875	44	21240	70	21840	68
13815	63	16886	49	21241	70	21841	68
13816	63	16930	45	21250	70	21842	68
13839	150	16933	43	21251	70	21843	68
13895	51	16934	44	21282	70	21844	68
13896	51	16956	43	21300	69	21847	68
13918	150	17026	146	21301	68	21848	68
13925	150	17055	46	21330	71	21849	68
13930	150	17056	46	21349	70	21850	68
15000	41	17057	46	21350	70	21872	68
15001	41	17058	46	21351	70	21873	68
15019	39	17059	46	21352	70	21879	68
15024	41	17060	46	21360	68	21885	68
15028	41	17061	48	21380	148	22052	83
15030	39	17062	48	21402	70	22053	83
15036	40	17063	48	21403	70	22054	83
15038	39	17064	48	21404	70	22055	83
15047	42	17162	48	21405	70	24012	74
15059	39	17163	46	21406	70	24013	75
15095	39	17164	46	21407	70	24017	74
15096	39	17165	46	21408	70	24018	74
15097	41	17166	46	21409	70	24019	74
15100	41	17168	46	21410	70	24020	75
15111	41	17169	46	21411	70	24021	75
15112	41	17170	46	21412	70	24022	75
15129	40	17175	48	21413	70	24023	75
15130	40	17176	48	21414	70	24024	75
15158	42	17177	48	21419	69	24025	75
15160	42	17178	48	21423	148	24035	76
15177	41	17180	48	21424	148	24062	76
15352	41	17181	48	21425	148	24089	75
16038	43	17182	48	21427	148	24101	75
16039	43	17275	46	21430	148	24134	73
16040	44	17277	46	21453	70	24140	76
16041	44	17278	48	21484	70	24154	75
16042	43	17337	46	21486	70	24193	133
16043	43	17338	46	21487	70	24194	133
16050		17339	46	21533	70	24195	133
16058	43	17340	48	21545	70	24196	133
16059	44	17341	48	21555	71	24198	76
16060	43	17521	47	21557	133	24200	76
16064	43	17522	47	21558	70	24201	76
16065	44	17523	47	21564	70	24202	76
16066	43	17524	47	21566	68	24208	83
16070	37	17539	48	21607	71	24209	83
16071	37	17540	48	21623	68	24210	83
16072	37	17541	48	21624	69	24211	83
16097	43	21024	69	21645	71	24216	75
16104	44	21025	69	21663	69	24232	76
16124	44	21033	148	21667	137	24258	76

Art.Nr.	Pagina	Art.Nr.	Pagina	Art.Nr.	Pagina	Art.Nr.	Pagina
24279	76	27122	78	31207	89	31877	149
24320	76	27124	78	31240	89	31884	87
24335	74	27201	152	31241	89	31955	87
24336	73	27209	78	31242	89	31956	87
24337	73	27219	78	31243	89	31957	87
24338	73	27223	78	31244	89	31959	87
24339	73	27227	80	31245	89	31964	87
24340	76	27230	80	31246	89	31965	87
24341	76	27233	80	31247	89	31966	87
24342	76	27235	80	31257	88	31967	87
24362	73	27236	80	31298	89	31968	87
24408	73	27239	80	31299	89	31970	87
24409	73	27240	80	31301	89	31971	87
24410	73	27241	80	31302	89	31972	87
24411	73	27244	80	31303	89	31973	87
24412	73	27245	80	31304	89	31974	87
24413	73	27246	80	31305	89	31975	87
24414	72	27248	78	31306	89	31976	87
24415	72	27249	78	31307	89	31979	87
24416	75	27267	152	31308	89	31981	87
24418	75	27268	152	31309	89	31983	87
24419	76	27269	152	31310	89	31984	87
26002	134	27270	152	31311	89	58001	124
26003	135	27286	152	31313	89	58004	125
26004	135	27292	152	31314	89	58009	124
26005	135	27297	152	31318	149	58010	124
26006	135	28000	153	31319	149	58013	125
26009	86	28001	81	31320	149	58018	124
26010	86	28003	81	31322	149	58019	124
26012	134	28004	81	31323	149	58022	125
26013	134	28006	81	31324	149	58027	124
26020	84	28008	81	31325	149	58028	124
26029	77	28009	81	31326	149	58031	125
26030	77	28010	81	31329	149	58036	126
26036	77	28011	81	31409	89	58037	125
26050	77	28012	81	31417	90	58502	157
26051	77	28013	81	31457	89	58503	157
26054	79	28015	81	31500	88	58511	157
26055	79	28017	81	31501	89	58602	157
26056	79	28042	153	31504	90	58607	157
26057	79	28043	153	31505	90	71028	96
27006	80	28044	153	31512	137	71082	97
27007	80	28045	153	31513	137	71094	97
27010	80	28101	82	31514	137	71095	97
27011	80	28102	81	31515	137	71097	97
27012	80	28103	82	31533	87	71105	97
27015	80	28104	81	31534	87	71118	96
27016	80	28105	82	31536	87	110000	34
27017	80	28106	81	31611	90	110014	35
27024	80	28107	82	31659	87	110015	35
27027	146	28108	81	31661	87	110016	35
27043	152	28109	82	31662	87	110017	35
27045	152	28111	81	31664	87	110018	33
27046	152	28112	81	31665	87	110019	34
27102	152	28181	84	31669	87	110020	35
27104	152	31027	149	31670	87	110073	26
27105	152	31032	149	31671	87	110322	26
27106	152	31082	90	31672	87	110383	27
27107	152	31085	88	31681	87	110413	29
27108	152	31086	88	31723	88	110624	26
27109	152	31150	149	31724	90	110635	26
27110	152	31151	149	31752	133	120025	151
27118	136	31152	149	31858	88	120026	151
27120	136	31162	149	31865	149	120027	151
27121	78	31183	90	31866	149	120029	151

Art.Nr.	Pagina	Art.Nr.	Pagina	Art.Nr.	Pagina	Art.Nr.	Pagina
120030	151	210403	148	K12210570	107	K13210061	107
120031	151	210405	148	K12210571	107	K13210062	107
120032	151	210406	148	K12210572	107	K13310067	113
120034	151	210408	148	K12210573	107	K13310071	113
120035	151	210409	148	K12210574	107	K13310072	113
120036	151	210410	148	K12310550	113	K13310074	113
120037	151	210415	148	K12310551	113	K13310077	113
120039	151	210422	148	K12310552	113	K13310078	113
120041	151	210539	68	K12310553	113	K13310080	113
120042	151	210540	68	K12310554	113	K13310081	113
120043	151	210541	68	K12310555	113	K13310082	113
120158	63	210550	133	K12310556	113	K13310084	113
120159	63	210587	70	K12310557	113	K13310085	113
120161	63	210593	70	K12310558	113	K13310086	113
120162	63	210599	70	K12310575	113	K13310087	113
120306	54	210600	70	K12310576	113	K13310089	113
120307	58	210605	70	K12310577	113	K13310090	113
120583	60	210606	70	K12410559	118	K13310092	113
120584	60	210762	70	K12410560	118	K13310093	113
120585	60	210765	69	K12410561	118	K13310094	113
120586	60	210766	70	K12410562	118	K13310096	113
120587	60	210824	146	K12410563	118	K13410098	118
120588	60	282001	81	K12410564	118	K13410100	118
120589	60	282002	81	K12410565	118	K13410102	118
120590	60	310058	149	K12410566	118	K13410103	118
120591	60	310059	149	K12410567	118	K13410104	118
120592	60	310060	149	K13110001	105	K13410110	118
K12VB0631	127	310123	133	K13110002	105	K13410111	118
K12VB0632	127	310163	149	K13110003	105	K13410112	118
121317	60	310167	149	K13110004	105	K13410114	118
122001	52	310168	149	K13110005	105	K13410115	118
130111	61	310171	149	K13110006	105	K13410118	118
132001	50	310175	149	K13110007	105	K13410121	118
132002	50	310182	149	K13110008	105	K13410122	118
160048	44	310194	149	K13110009	105	K13510125	121
160049	44	310311	133	K13210010	107	K13510126	121
160052	44	310331	89	K13210012	107	K13510128	121
160053	44	310334	89	K13210013	107	K13510129	121
160055	44	310344	89	K13210014	107	K13510131	121
160056	44	310345	89	K13210016	107	K13510133	121
160057	44	310350	89	K13210017	107	K13510134	121
160087	135	310351	89	K13210019	107	K13510135	121
160177	44	310352	89	K13210020	107	K13510142	121
160178	44	310356	89	K13210021	107	K13510145	121
160179	44	310357	89	K13210022	107	K236984001	123
160182	49	310362	89	K13210023	107	K236984002	123
160184	49	310363	89	K13210026	107		
210030	69	310364	89	K13210027	107		
210067	133	310415	89	K13210028	107		
210077	148	310417	89	K13210030	107		
210078	148	310491	89	K13210031	107		
210169	68	310494	88	K13210035	107		
210170	68	310495	89	K13210037	107		
210171	68	310567	146	K13210038	107		
210176	68	580020	157	K13210042	107		
210178	68	581640	124	K13210043	107		
210179	68	581642	157	K13210046	107		
210184	68	581644	124	K13210048	107		
210185	68	581646	157	K13210049	107		
210186	68	K12210546	107	K13210051	107		
210193	68	K12210547	107	K13210052	107		
210197	68	K12210548	107	K13210053	107		
210234	70	K12210549	107	K13210056	107		
210256	148	K12210568	107	K13210057	107		
210265	148	K12210569	107	K13210058	107		