

PCE

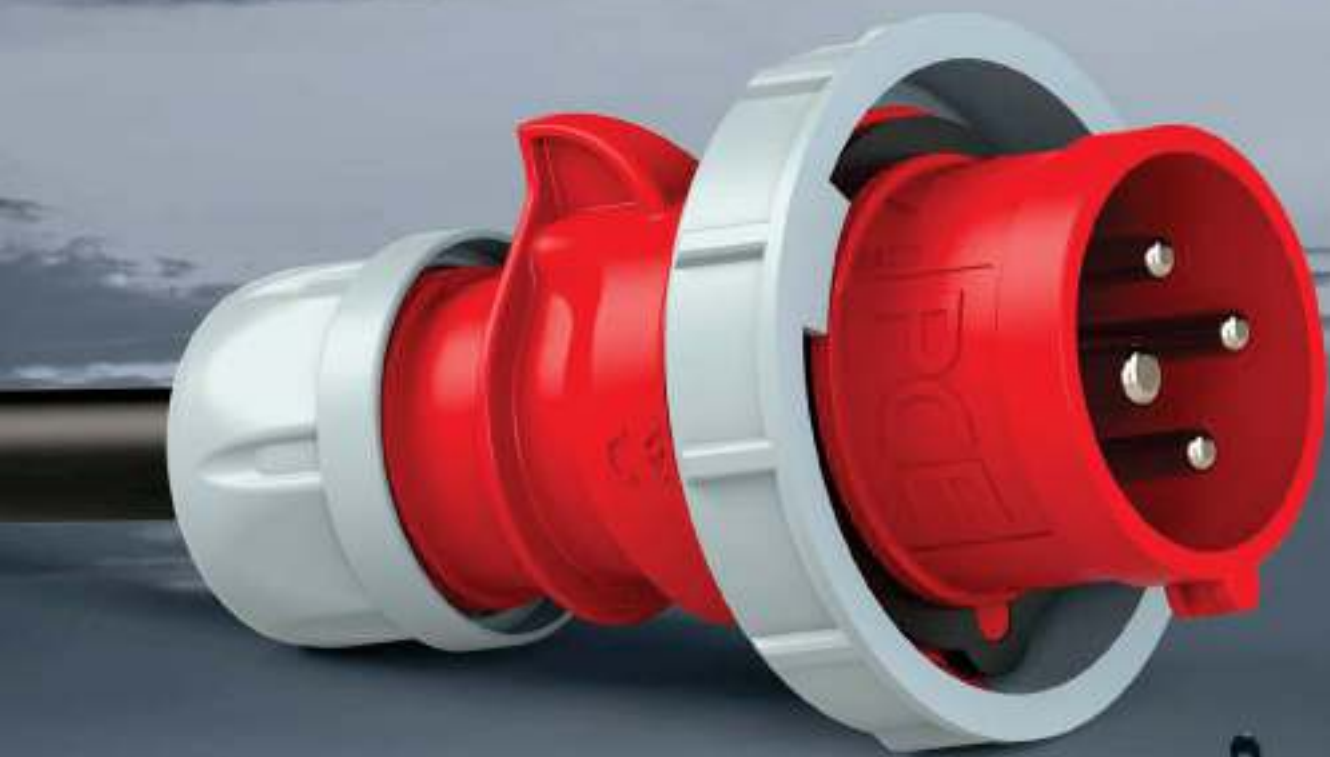

MADE IN AUSTRIA



CONTAINER PLUGS AND SOCKETS

PCE container plugs and sockets are specially designed for the rough condition on reefer-containers, at harbors and terminals.

- 32A, 4-pole, 3h, 440V
- IP rating IP67
- nickel-plated contacts
- robust design
- external, centric cable gland
- with Lloyd's Register Type Approval



Container products:

- plug* and connector
- wall socket
- flanged socket straight/sloping
- switched interlocked socket*
- switched interlocked socket with fuse*
- special distribution boxes (on request)

*with Lloyd's Register Type Approval



Container plugs and sockets



Container Plug **SHARK**

- 32A 4p 3h 440V
- nickel-plated contacts

IP66/67 watertight



0242-3v

pack.unit: 10

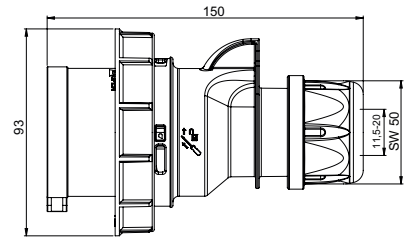

Container Connector **SHARK**

- 32A 4p 3h 440V
- nickel-plated contacts

IP66/67 watertight

2242-3v

pack.unit: 10

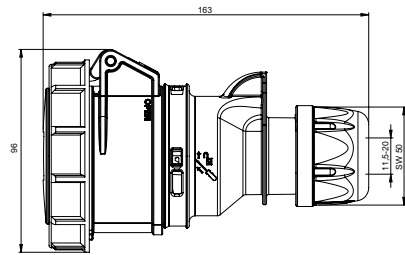

Container Wall socket

- 32A 4p 3h 440V
- nickel-plated contacts

IP67 watertight

1242-3v

pack.unit: 5

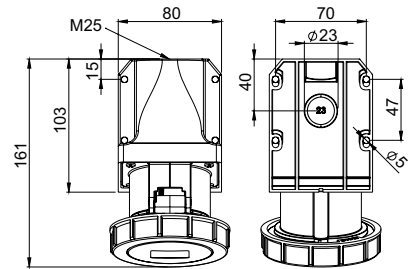

height=108mm
angle=15°



Container Flanged socket straight

- 32A 4p 3h 440V
- nickel-plated contacts
- flange = 75 x 75
- fixing center = 60 x 60

IP67 watertight

3242-3v

pack.unit: 10

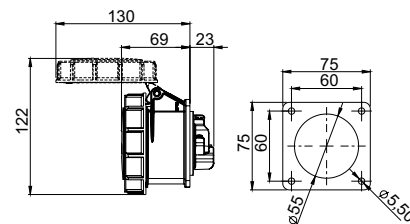

Container Flanged socket sloping

- 32A 4p 3h 440V
- nickel-plated contacts
- flange = 80 x 97 mm
- fixing center = 60 x 73 mm

IP67 watertight

4242-3f78v

pack.unit: 10

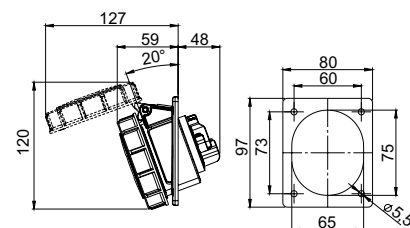

Container Switched interlocked socket

- 32A 4p 3h 440V
- nickel-plated contacts
- up to 3 x M25 cable entries
- mechanical interlock
- lockable by padlock

IP66/67 watertight



75242-3

pack.unit: 1

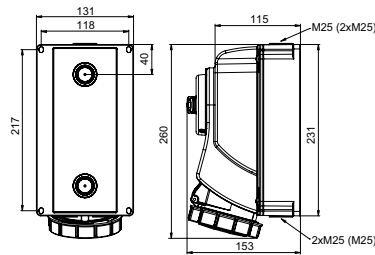

Container Switched interlocked socket with DIN rail

- 32A 4p 3h 440V
- nickel-plated contacts
- DIN rail with window for 5 modules
- up to 3 x M25 cable entries
- mechanical interlock
- lockable by padlock

IP66/67 watertight



76242-3

pack.unit: 1

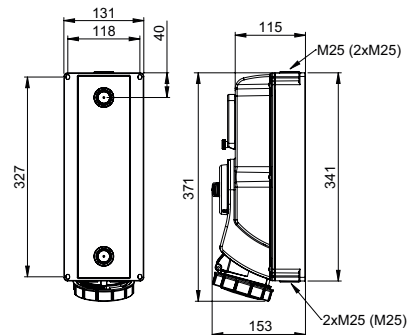

- compact design for wall mounting
- nickel-plated contacts
- Series 76/78... with window for 5 units, cap dimensions: 45mm
- mechanical interlock:
after plugging and switching-on **plug is locked**
after switching-off and unplugging **switch is locked**
- all components are mounted on bottom
- **large connecting area - easy of installation**
- possibility for wiring through
- ready wired for connection
- at switch-off position: lockable by padlock (40 mm)

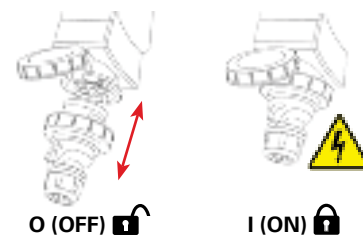

Detailed information see page 106 „Switched interlocked sockets“.

